

**AT** MICROFICHE  
REFERENCE  
LIBRARY

A project of Volunteers in Asia

Water for the Thousand Millions

Edited by: Arnold Pacey

Published by:  
Pergamon Press  
Maxwell House  
Fairview Park  
Elmsford, NY 10523 USA

Paper copies are 2.90 British pounds.

Available from:  
Intermediate Technology Publications, Ltd.  
9 King Street  
London WC2E 8HN England

Reproduced by permission of Pergamon Press.

Reproduction of this microfiche document in any form is subject to the same restrictions as those of the original document.



# WATER FOR THE THOUSAND MILLIONS

Written by the Water Panel of the Intermediate  
Technology Development Group founded by  
Dr. E. F. Schumacher

Compiled and Edited by  
Arnold Pacey



PERGAMON PRESS

**WATER FOR THE  
THOUSAND MILLIONS**

*This study was commissioned by the Secretariat of the United Nations Water Conference 1977 and funded by a grant by the Government of the United Kingdom.*

# **WATER FOR THE THOUSAND MILLIONS**

*Written by the Water Panel of the Intermediate  
Technology Development Group founded by  
DR. E. F. SCHUMACHER*

*Compiled and Edited by*  
**ARNOLD PACEY**

FROM WORK BY

THE EDITORIAL GROUP	AND	OTHER PANEL MEMBERS
David Bradley (Chairman)		Colin Allsebrook
Ian Carruthers		James Fraser
Richard Feachem		Jack Hindson
Bill Wood		James Howard
Elizabeth Burge		Henry Mann
		Duncan Mara
		Simon Watt



**PERGAMON PRESS**

OXFORD · NEW YORK · TORONTO · SYDNEY · PARIS · FRANKFURT

U.K.	Pergamon Press Ltd., Headington Hill Hall, Oxford OX3 0BW, England
U.S.A.	Pergamon Press Inc., Maxwell House, Fairview Park, Elmsford, New York 10523, U.S.A.
CANADA	Pergamon of Canada Ltd., 75 The East Mall, Toronto, Ontario, Canada
AUSTRALIA	Pergamon Press (Aust.) Pty. Ltd., 19a Boundary Street, Rushcutters Bay, N.S.W. 2011, Australia
FRANCE	Pergamon Press SARL, 24 Rue des Ecoles, 75240 Paris, Cedex 05, France
WEST GERMANY	Pergamon Press GmbH, 6242 Kronberg-Taunus, Pferdstasse 1, Frankfurt-am-Main, West Germany

---

Copyright © The United Nations, 1977

*All Rights Reserved. No part of this publication may be reproduced, stored in a retrieval system or transmitted in any form or by any means: electronic, electrostatic, magnetic tape, mechanical, photocopying, recording or otherwise, without permission in writing from the publishers*

First edition 1977

**Library of Congress Cataloging in Publication Data**

Intermediate Technology Development Group. Water Panel.  
Water for the thousand millions.

I. Water-supply. I. Pacey, Arnold. II. Title.  
TD345.155 1977 363.6'1 77-23127  
ISBN 0 08 021805-9 (flexi cover)

# CONTENTS

	<i>Preface</i>	vi
<b>Part I</b>	<i>Water supply objectives and criteria of appropriateness: Introduction</i>	1
<b>Part II</b>	<i>Technically appropriate water supplies</i>	9
	<i>(a) Health and sanitary appropriateness</i>	10
	<i>(b) Functional appropriateness</i>	21
	<i>(c) Environmental appropriateness</i>	25
<b>Part III</b>	<i>Socially appropriate water supplies at village level</i>	34
<b>Part IV</b>	<i>Economically appropriate water supplies</i>	46
<b>Part V</b>	<i>Conclusion - Water for the thousand millions</i>	53
	<i>References</i>	58

## PREFACE

Many papers have been, and will be, prepared for the United Nations Water Conference. Most will have their subject matter defined geographically or by subject. This article does not *give* a well-balanced judicious account but rather is an attempt to *produce* balance by emphasising those aspects most neglected. Some topics may appear to be discussed in a more clear-cut manner than the real world they reflect justifies. We are well aware of this, but this is the way to be provocative! Readers who feel their area has been summarily dealt with are asked to bear this in mind.

We have set out to discuss technology of an appropriate sort and ended up considering organisation and maintenance. In its first version the title was 'Technology is not enough'. This is not to belittle technology (and many and better devices are needed to improve water supplies), rather we wish to emphasise that organisation and maintenance are of at least equal importance. In some countries the most cost-effective way of increasing the population supplied with domestic water is to cause those systems that exist to work.

We hope that our contribution will assist the Conference in its efforts to encourage the best and most appropriate water supplies and use for the people of the world.

It is appropriate here also to pay tribute to the work of M. G. Iodindas in developing many of the ideas on water technology which were subsequently taken up by I.T.D.G.

*Intermediate Technology Development Group,  
9, King Street, London, England.*

**David Bradley**  
*(Chairman)*



# WATER FOR THE THOUSAND MILLIONS

## PART I: WATER SUPPLY OBJECTIVES AND CRITERIA OF APPROPRIATENESS: INTRODUCTION

In the immediate post-war years, many people believed that Western technology, wisely used, could solve all the world's material problems. It could feed a growing population for all the foreseeable future; it could clothe and house the world's people, give them water and maintain their health. The promise of a continuously evolving, innovative technology seemed unlimited.

But it soon became apparent that this scheme of things was not working out. The application of Western technology in developing countries seemed to be encouraging a drift of population to the towns and creating unemployment; what was worse, it absorbed so much capital that a poor country could only use it sparingly. This meant that only a minority of people could benefit, and with specific regard to water supplies, WHO estimated in 1973 that this left 86 per cent of the rural population without "reasonable access to safe water."

One response to this situation in the mid-1960s was E.F. Schumacher's very timely reminder that the use of recent Western technology in the developing countries was a matter of choice, not necessity. There were, in fact, many different kinds of technology to choose from, some of a traditional kind, some modern and scientific; some demanding a large labour force, others requiring heavy energy consumption. He suggested the concept of an *intermediate technology* (Schumacher, 1965) which would select from these possibilities the ones which made maximum use of local resources and required only an intermediate or low capital investment—it would be a form of technology whose benefits could be made widely available among the people who most needed them. The emphasis in water supply was thus to be low-cost systems available to everyone, using self-help and voluntary labour wherever possible to reduce the investment required. And since most of the world's people live in rural communities, not towns, he suggested that this should be a technology capable of small-scale application, suitable for village use and local control. Several publications by the Intermediate Technology Development Group illustrate the application of this concept to water supplies (ITDG, 1969; Mann and Williamson, 1973).

---

The views expressed in this paper are those of the authors and do not necessarily reflect those of the United Nations.

So in considering "the promise of technology," one of the two main themes of the UN Water Conference, one is tempted to assume that the promise of high technology from the West is fading, and that it would be more relevant instead to discuss recent developments in the intermediate technology of water supplies—for example, rainwater catchment tanks, new water conservation techniques, the small-scale use of solar energy for the desalination of sea water, and the potential of wind-driven pumps for borehole pumping and irrigation. This paper will in fact make reference to rainwater catchment and water conservation, and it might also have described small solar distillation plants (in Haiti and Kenya) or wind-pump projects (in India, Sudan and Tanzania—Fig. 1). But however interesting and novel the technology involved in these projects, and however much needed in current conditions of shortage of resources, for this paper to emphasize technological novelty of this kind would be to divert attention from more vital issues relating to water supplies. The solar distillation and wind projects mentioned have in most cases run into exactly the same problems as beset more conventional water supplies—short-term technical success in four of the five countries mentioned has been followed by long-term deterioration and failure, because equipment is not adequately maintained or properly operated. The same is true for simpler and more conventional kinds of equipment, such as hand pumps and the most basic piped water supplies. So perhaps the promise of intermediate technology has begun to fade as well.



*Fig. 1. The promise of technology when appropriate organization for operation and maintenance is lacking. A wind-pump and cattle drinking trough in Tanzania. (photo: David Bradley).*

But to think that is to misunderstand the nature of technology. Neither the high technology of the West nor intermediate technology is an entity in itself. Each is an expression of human organization and culture, and of the goals and objectives of human society. Neither is capable of realizing its full promise if used in circumstances where the organization needed to operate it is lacking, as in the unsuccessful projects just mentioned, or when goals and objectives are ill-defined. So technology by itself promises nothing; there is no purely technological solution to the problems of poverty and underdevelopment. Technology only yields its full benefits when used within a framework of social development and strengthened organization.

But if technology promises nothing, it offers a great deal, and the key concept in Schumacher's argument was his stress on the need to make choices among the vast and growing range of techniques now available. This paper, then, is not about the *promise* of new water supply technology, but simply about the *choice* of technology and the criteria needed to make sound choices. These criteria are discussed using a vocabulary based on the concept of appropriate technology, a broader but possibly less precise term which has been used alongside the intermediate technology concept in recent years; and the theme of the paper may be summarized as "appropriate water supplies."

#### *Appropriate water supplies*

Because the successful application of technology depends so vitally on the organization, discipline and skill of the people who must operate and maintain it, the selection of an appropriate technology must be accompanied by the creation of appropriate organization (including appropriate institutions, appropriate training facilities and so on, where these do not already exist). This may be organization at village level concerned with the allocation of responsibilities for cleaning and maintaining the equipment, but it will often need to be backed up by organization at local government level, related to training, extension, maintenance and purchasing of spare parts.

To the Western-trained specialist, accustomed to thinking of technology, organization and people in separate mental compartments, the way in which these things have to be related can be very baffling. So it may help to use the language of systems theory, and to look at a village water supply as part of a system which includes government agencies, health services, community organizations and individual people as well as technology in the form of pumps, pipes and other hardware. The input of new equipment to the system must usually be accompanied by other complementary inputs if the full benefits of the water supply are to be realized in practice, and these complementary inputs will most commonly be in the general area we have called "appropriate organization"—organization for pump maintenance, for health education, for watering cattle, for changed patterns of water use within the home, and so on.

#### *Criteria of appropriateness*

The stress on appropriate organization which we are learning to regard as vital for the successful operation of a developing country water supply brings a whole range of social issues into discussions of technology which the original case for intermediate technology did not consider. This case was primarily an economic one, to do with choosing techniques which made more modest use of capital resources and more rational use of available labour and local materials. Such points about the use of resources are still relevant, of course, but they are now seen to be criteria only of *economic appropriateness*, when

what is required is a water supply which is also *socially appropriate, environmentally appropriate*, and appropriate from the *health* point of view.

These different kinds of appropriateness were suggested by Farrar (1974) as criteria for making choices between the various possibilities which technology offers, and they are all related either to the ultimate objectives of the water supply, or to the local conditions in which it has to operate. It is necessary to stress, then, that the criteria of appropriateness cannot be clearly defined unless the goals and objectives of the project have also first been clarified. Objectives have social, economic and technical aspects, so we have to deal with these three kinds of appropriateness.

An example of how this applies in practice was provided by a recent discussion between two foreign agencies which give grants for borehole development in India. The objective of one of these agencies was simply to provide water, on the grounds that this would be beneficial to health. The other agency looked upon its water supply projects as a means of promoting self-reliance and community development in the villages, as well as improving health, so paid a lot of attention to appropriate organization. Given this difference in objectives, it was not surprising to find that the first agency solely used criteria of technical appropriateness in selecting equipment for its boreholes, while the second agency also emphasized criteria of social appropriateness. The difference this made became very apparent when it came to choosing hand pumps. The first agency selected a rather expensive pump which seemed capable of reliable operation for long periods—possibly up to a year—without any maintenance. The second agency, however, busied itself with organizing village-level pump maintenance, and selected a type of pump which was far cheaper and probably less reliable, but which was very easy for a local, relatively unskilled group to maintain.

Different objectives thus led to different criteria of appropriateness being used, and

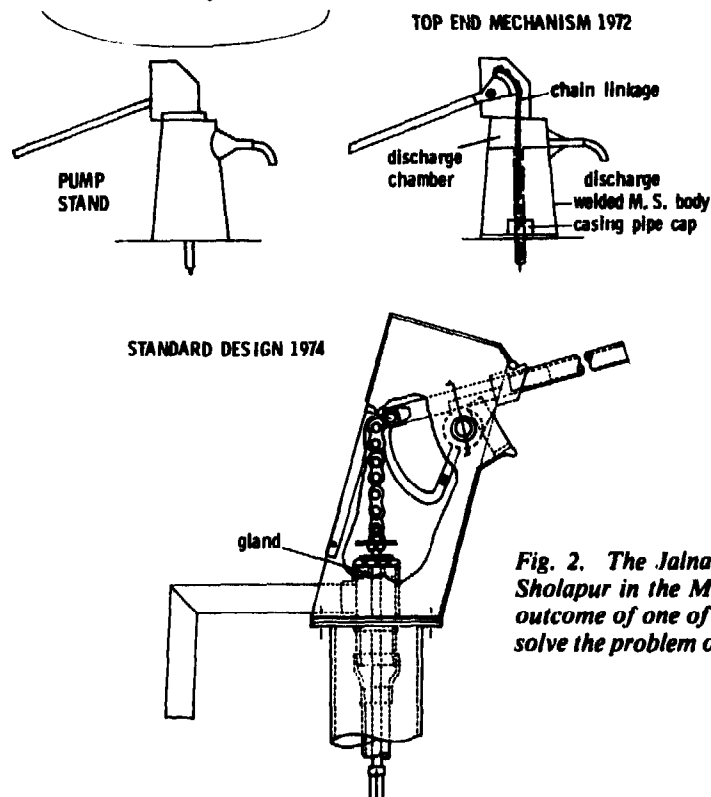

Fig. 2. The Jalna-type hand-pump. Produced at Jalna and Sholapur in the Maharashtra state of India, this pump is the outcome of one of the most determined efforts so far made to solve the problem of hand-pump maintenance.

different choices being made even with regard to equipment as basic as hand-pumps. The moral of the story was somewhat blurred in practice, though, because the first agency eventually found that the highly reliable pump it wished to use was too expensive; it turned instead to a pump originally designed at the former Jalna mission in Maharashtra, improved by the Sholapur Well Service, and now widely used by UNICEF (Fig. 2); and the second agency also used the Jalna pump in a number of instances because its ideal, easily maintained pump was not available.

#### *Objectives of water supply improvement*

In the design of water supply systems for high-income communities in the developed countries, the question of goals and objectives is not often discussed because a certain high-level provision of water services has come to be regarded as essential. Standards are laid down in codes of practice and legislation, and are taken for granted without anybody questioning whether the original objective was mainly to do with health, convenience, or some other purpose. So when Western engineers have worked on water supplies for low-income countries, they have not usually had any clearer objective in mind than to have "safe" water flowing out of the end of a pipe. However, for the great majority of the world's population who live in rural communities or urban slums, with grossly inadequate access to safe water, there is no possibility that available financial and human resources will give them the same high level of water provision as that enjoyed by the people of North America and Europe. And simply because resources are so limited, it is necessary to examine closely the goals of water supply in order that what resources are available may be allocated in the most rational manner. If the highest level of water provision is unattainable, that does not mean there is nothing worth attempting—there are usually many improvements possible which, though falling short of the ideal, may have a very considerable impact on health or on other problems of the local community.

It is relevant to quote Voltaire's comment, that the best is the enemy of the good. The danger in water supplies is that one may be distracted from good and useful improvements by the vision of what may be best, but is not really attainable. The way to avoid this danger is carefully to define goals for water supply development, possibly using a scheme such as that of Table 1. In this table, under "immediate objectives," are listed the improvements to water which, in some combination, will form the basis of the design. For a high-grade water service in a prosperous community, the immediate objectives have become established as to provide high quality (i.e. clean, safe) water in abundant quantity, with unlimited availability and total reliability. However, these aims are out of reach for the majority of the population of developing countries, and so some other combination of improvements in quality, quantity, availability and reliability must be decided on for the purpose of design (Feachem, 1975). In order to know what combination of improvements is most desirable in a particular case, it is necessary to examine the potential benefits from a water supply and so assess the degree to which different improvements will realize different levels of benefit. In this way the improvements with the most impact, at a given cost, can be determined and the anticipated cost-effectiveness of alternative schemes can be compared.

Table 1. Goals and objectives for water supply improvements in rural areas of developing countries

<i>Immediate Objectives</i>	<i>Further goals—stage I</i> (these follow as consequences when the immediate objectives have been met)	<i>Further goals—stage II</i> (these follow from previous stages if complementary inputs are provided)	<i>Further goals—stage III</i> (these are consequences of reaching the previous goals which follow if there are also inputs on many other fronts)
<b>FUNCTIONAL:</b> to improve the quality, quantity, availability and reliability of the supply  <b>OTHER:</b> to carry out this improvement in a manner which (a) secures the support of users; (b) conserves scarce resources (e.g. capital); (c) avoids adverse environmental consequences (e.g. lowering water tables, encouraging mosquitoes)	<b>HEALTH:</b> to reduce incidence of water-borne and water-based disease  <b>ENERGY/TIME (ECONOMIC):</b> to save time and energy expended in carrying water  <b>SOCIAL:</b> to arouse interest in the further health and economic benefits which may arise from the water supply  <b>ECONOMIC:</b> to provide more water for livestock and garden irrigation; (water may be used for this even if it is intended solely for domestic supply)	<b>HEALTH:</b> to reduce incidence of water-washed infections (inputs required: improved hygiene, health education, improved sanitation)  <b>SOCIAL/TECHNICAL:</b> to ensure good long-term maintenance of water supply and sanitation facilities (inputs required: training, clear allocation of responsibility, build-up of local maintenance organization)  <b>ECONOMIC:</b> to use energy/time savings and increased water availability to achieve better agricultural output (inputs required: extension work, fertilizer supply, etc.)	to achieve the greater well-being of the people through:  (a) social change—greater self-reliance in the community, better organization, better deal for the poor, women, etc.  (b) improved standard of living - health, nutrition, income, leisure

Table 1 lists three stages of potential benefits or goals. These are organized partly chronologically in that Stage I benefits are likely to be realized before Stage II which will usually precede Stage III. They are also arranged according to the extent to which external, or complementary, development inputs and initiatives are necessary to achieve the stated benefits. Of the two agencies just quoted which were involved in borehole work in India, the first was concentrating only on Immediate Objectives—the supply of water—while the second was looking to Stage III goals, which required a wide range of complementary inputs, especially involving technical training and community development. In fact, Stage III goals almost always entail a wider range of inputs, and in general, as one moves from left to right across Table 1, not only does one move chronologically, but also with respect to the magnitude and feasibility of the complementary inputs which are necessary.

The most important Stage I goals relate firstly to changes in the time and energy which villagers (usually women) expend in carrying water, and secondly, to improvement in health. Further improvement in health is obtainable as a Stage II goal with a complementary input related to changes in hygiene practice. Such changes may occur automatically as soon as more water is available, but most people will need to be told about the importance of hygiene by means of a health education input.

Another Stage II goal is that of assuring the long-term future of the water supply by complementary inputs connected with the organization of maintenance. Neglect of this aspect in so many water supply projects shows that it cannot be regarded simply as part of the reliability aspect of the Immediate Objectives. The long-term survival of the water supply in good working condition is so rarely achieved that this is obviously one of the goals most in need of clearer definition. And since it is heavily dependent on complementary inputs, it must be classed as a Stage II goal.

Apart from this question of maintenance, however, the two goals with which we are most concerned are those to do with reducing health risks associated with water, and with reducing the amount of time and energy which people must devote to carrying home their supply. White *et al.* (1972) look on ill-health and water-carrying time as two aspects of the *cost* of water for people in developing rural communities, and the two principal goals for water supply improvement may therefore be described as reducing the *health cost* and the *time/energy cost* of water.

In discussing the choice of hand-pumps for boreholes in India, we have already seen how different objectives lead to the application of different criteria of appropriateness. With the goals of water supply improvement now more fully defined, we can illustrate this relationship between objectives and criteria on a broader basis (Table 2). Immediate

*Table 2. Some criteria of appropriateness in relation to the water supply objectives from which they are derived (Stage III goals are not considered)*

Criteria derived from IMMEDIATE OBJECTIVES	Criteria derived from STAGE I GOALS	Criteria derived from STAGE II GOALS
<b>1. Criteria of TECHNICAL APPROPRIATENESS:</b>		
<i>Functional appropriateness</i> fitness for purpose	<i>Health and Sanitary appropriateness</i> water-borne disease data and water quality	<i>Health and Sanitary Appropriateness</i> water-washed disease data and water quantity and availability
<i>Environmental appropriateness</i> fitness for hydrological conditions, avoidance of environmental damage		
<b>2. Criteria of SOCIAL APPROPRIATENESS:</b>		
<i>Community appropriateness</i> felt needs and stated preferences in the community. scale in relation to community size and organization.	<i>Consumer appropriateness</i> changes in water carrying and in water use patterns	<i>Maintenance appropriateness</i> organization, administration, village/government responsibilities, spare parts supply, training, record-keeping
<i>Work appropriateness</i> organization of labour force (whether self-help or paid)	<i>Educational appropriateness</i> degree of interest created in health, hygiene and other development	
<b>3. Criteria of ECONOMIC APPROPRIATENESS:</b>		
<i>Resource Utilization appropriateness</i> capital and labour intensity, import bill, fuel consumption; scale economies		<i>Production appropriateness</i> amount of time/energy saving and volume of water available for productive purposes

Objectives lead to technical, economic and social criteria for the appropriateness of a water supply, but Stage I and Stage II goals lead principally to criteria of social appropriateness (with some technical criteria relating to health—Table 2).

*Interpreting the objectives: politicians, planners and villagers*

Reduction of health costs of water to users, and of time/energy costs would probably be accepted as important objectives for new water supply development in most countries of the world. Such goals do, however, represent a value-judgement, and their interpretation and application require further value-judgements. Thus although the planner may adopt the approach suggested in the previous paragraph, his assessments of the overall cost of water in different communities do not automatically determine which communities should have highest priority for an improved supply. In some countries, the prevalent value-judgement may be that investment in water supplies should only be made where it can have a direct effect on economic development at the level of Stage II and Stage III goals. In this situation, the heavy health cost of water in a remote subsistence farming community would seem unimportant.

Alternatively, the values and philosophy of a particular country may stress the importance of helping the poorest members of society by redistributing wealth and sharing the benefits of development widely, and therefore high health and time/energy costs and the hardship associated with them may be regarded as a sufficient reason for providing a water supply wherever they occur. Yet other countries may feel it important to stress rural development, hoping to counter the drift of population to urban centres, and thus may be more concerned about the cost of water in rural communities than in towns. National policies will also differ as to the importance of self-help and community development in securing their wider aims, some (especially in Africa) relying on it extensively, while other countries discard it because in their circumstances it fails to work.

Each of these value-judgements belongs to the decision-making process at the political level, and the values involved are implicit in the political philosophies of governments and ruling parties. In many countries, water supply policies are not sufficiently explicit, or not sufficiently well thought out for their relationship to political philosophies to be apparent. However, Tanzania provides an example of a country where water supply has been extensively studied by resource and land use planners in the University of Dar es Salaam, and in their numerous carefully researched papers, Stage III goals relating to Ujamaa socialism and various egalitarian ideals are strongly emphasized.

But of course, political decisions are not made purely on the basis of political ideals. Politicians need to stay in power, and their decisions are inevitably influenced by knowledge of where their support lies, and how it may be maintained. This is part of the reason for the bias in many countries towards urban rather than rural water supply development. There are also pressures from business and commercial interests, and the position is further complicated by foreign aid and technical assistance. Whether the aid comes from a foreign government, a United Nations agency, or a charitable organization, these agencies must inevitably bring their own values to bear on the decision about whether to provide money.

Several British agencies, including government ones, are now committed to a "helping



the poorest” strategy rather than stressing economic development above all else. Some small charities, indeed, have implicit but highly developed ideologies relating to Stage III goals, and within the new technological agencies now springing up in Britain, Holland and North America, there is disagreement as to whether it should be the role of appropriate technology to stimulate social change in the direction of fairly radical Stage III goals, or whether appropriate technology should consist only of a pragmatic, technical approach to Immediate and Stage I objectives.

But while the overall water supply policy for a country depends on political decisions at government level, the implementation of a specific village water supply may depend on value-judgements by individuals within the village, as to whether they support the project, and whether they contribute willingly to any self-help element involved. Gaining the support of villagers will involve listening to their opinions, and ideally, it will mean their participation in the planning process, with some final decisions about objectives left in their hands. For example, villagers may have their own opinions about which of the Stage I goals is more important, the reduction of time and energy used in carrying water, or improvement in health. They may be particularly concerned about the prevalence of some particular disease—in one Lesotho project, it happened to be typhoid—and where the object of concern is a water-related disease, the possibilities of reducing its incidence by use of the new water supply can be discussed with the villagers and balanced against other aims they may have, such as making more water available for irrigating small gardens or for animals to drink.

The criteria of appropriateness we shall discuss in the remainder of this paper will all be related to the “Immediate” and “Stage I” objectives set out in Table 2, which are objectives common to water supply projects all over the world. However, since these objectives may be given a particular emphasis either by national political decisions or by village-level choices, so too must criteria of appropriateness differ in detail from country to country. One may say, in fact, that “political appropriateness” is an over-riding influence which may modify to some degree all the other criteria, though, in many cases, this will be a detailed modification which we shall ignore.

## **PART II: TECHNICALLY APPROPRIATE WATER SUPPLIES**

### *Fitness for purpose*

Technical appropriateness has to do with fitness for purpose, and with whether the equipment and techniques used in a particular project are relevant to the general objectives of the water supply concerned. It is this part of our subject which would traditionally be regarded as the proper field of public health engineering. However, we shall argue that many criteria which public health engineers conventionally use have little to do with the general concept of appropriateness, and have little relevance to realistic water supply objectives in developing countries. There are three aspects of technical appropriateness to consider:

- (a) health and sanitary appropriateness—fitness of the water supply techniques with regard to the improvements in health expected (Stage I and Stage II Goals in Table 1);
- (b) functional appropriateness—fitness of the equipment from the point of view of design and performance, and its relevance to the Immediate Objectives of providing better quality water, more water, and a more reliable supply;

- (c) environmental appropriateness—fitness of the equipment to operate in the physical environment of the region concerned, and to avoid adverse effects on the environment (Immediate Objectives).

## **PART II(a): HEALTH AND SANITARY APPROPRIATENESS**

### *Water-related disease*

In order to assess whether a particular water supply is appropriate to the objective of improving the health of the people who use it, one needs to have a fairly precise idea of the connections between water, hygiene, sanitation and health. In tropical countries between twenty and thirty different infective diseases may be influenced by changes in water supply. They are usually classified by the microbes causing them, into viral, bacterial, protozoal and helminthic diseases. But this is not very helpful in considering the effects of improved water supplies. What is more relevant is the mode by which the diseases are spread, and it is more useful to have four main categories.

- (1) Infections spread *through* water supplies—these are the true *water-borne* diseases;
- (2) Diseases due to lack of water for personal hygiene—these are described here as *water-washed* diseases;
- (3) Infections transmitted through an aquatic animal—water-based diseases, and
- (4) Infections spread by insects that depend on water, referred to as diseases with *water-related insect vectors*.

The structure of this recent classification is shown in Table 3, and is discussed in greater detail elsewhere (White *et al.*, 1972; Bradley 1974; Feachem, 1975). Here it is sufficient to note that WATER-BORNE diseases are those carried by water which is polluted with human or animal faeces. If those who pollute the water are suffering from intestinal infections (including cholera and typhoid), those who drink the water will ingest the organisms causing these infections, and may become ill. Control of such infections depends on improving water QUALITY.

If people have very little water, either because there is extremely little water available or because it is too far away and cannot be carried home in quantity, then it may be impossible to maintain reasonable personal hygiene. There may be too little water for washing oneself, or food utensils or clothes. Remaining unwashed not only allows skin infections to develop unchecked but also makes it easier for intestinal infections to spread from one person to another on dirty fingers—indeed, all intestinal infections already described as “water-borne” may also be spread this way. In practice, these are an important group of diseases in the tropics and may be called the WATER-WASHED infections as they result from lack of water for washing or personal hygiene. Clearly their prevention depends on availability, access to, and QUANTITY of domestic water rather than its quality.

In the tropics there are some worm infections which are not spread passively from person to person in the water. The parasite eggs or larvae which reach water are not directly infective to man, but *are* infective to specific invertebrate water animals, chiefly snails and crustaceans. Development takes place within these intermediate hosts from which, after a period of days or weeks, further larvae mature and may be shed into the water. These larvae are infective to people drinking or having contact with the water. Such worms may

Table 3. Classification of infective diseases in relation to water supply

Category	Examples	Relevant water improvements
<b>I. WATER-BORNE INFECTIONS:</b>		
(a) Classical	* Typhoid * Cholera * Bacillary dysentery * Amoebic dysentery	<b>IMPROVE QUALITY</b> Aim for maximum microbiological quality of water
(b) Non-classical	* Infective hepatitis * Gastroenteritis	Improve microbiological quality of water
<b>II. WATER-WASHED INFECTIONS:</b>		
(a) Skin and eyes	Skin sepsis and ulcers Trachoma Conjunctivitis Scabies Yaws Leprosy	Provide a greater volume
(b) Diarrhoeal diseases	* Bacillary dysentery * Amoebic dysentery * Infective hepatitis * Gastroenteritis	of water, facilitate access and encourage its use
<b>III. WATER-BASED INFECTIONS:</b>		
(a) Penetrating skin	Schistosomiasis	<b>SPECIFIC MEASURES:</b> Reduce contact with infested water
(b) Ingested	Guinea-worm	Protect water source
<b>IV. INFECTIONS WITH WATER-RELATED INSECT VECTORS:</b>		
(a) Biting near water	Sleeping sickness	Clear vegetation
(b) Breeding in water	Onchocerciasis Yellow fever	Avoid need to visit source Provide reliable supply
<b>V. INFECTIONS PRIMARILY OF DEFECTIVE SANITATION:</b>		
	Hookworm  (to some extent, most diseases in previous categories also)	Provide sanitary faecal disposal

\*These diseases may be spread by any process which allows material from human faeces to be ingested, i.e. they may spread *either* as water-borne *or* as water-washed infections.

be called **WATER-BASED** infections, and special measures to remove the water snails or other hosts from the water, or other special action is needed to make the water safe.

Lastly, there are many tropical infections spread by biting-insects. Most of these, notably the mosquitoes, breed in pools or other open water, and sometimes even in household domestic water containers. Tsetse flies are active near to water, so the most vulnerable people are those who, lacking piped supplies, must visit the water source very frequently. These **WATER-RELATED INSECT VECTORS** may sometimes be affected by improvements in domestic water supplies.



*Fig. 3. One objective for water supply development is improved availability of water - an urgent need when this photograph was taken at a borehole in Botswana. (photo: Peter Keen).*

It is neither possible nor desirable to separate water-related diseases completely from those affected by sanitation. All the water-borne and some of the water-based diseases depend for their spread on material from human faeces getting into drinking water or food. The chain of transmission may be broken by safe disposal of faeces as well as by protection of the water supplies. Even some of the water-washed intestinal infections may be reduced if better sanitary conditions lessen the soiling of hands. There are also a few infections, of which hookworm is most significant, where sanitation is much more important than water, because transmission is from faeces to soil and by direct penetration back through the human skin. The fifth category in Table 3 includes such cases as this.

#### *Water supply design in relation to the prevalence of disease*

These categories of water-related disease may be used with good effect to classify the prevalent diseases in an area where water supply improvements are planned. If this is done, a guide to priorities in water supply design may be built up, which will be especially

valuable in circumstances where funds are limited. For example, if typhoid is a major problem in the area, then priority must be given to providing treated water which is free from infection, but if skin diseases and trachoma are an overwhelming problem (as they are in some semi-desert areas), then providing a greater *quantity* of water will be of greatest importance even if it is untreated and of more doubtful quality.

In fact, the most important and most common water-related infections in many areas are diarrhoeal diseases, including those marked with an asterisk in Table 3, which may be transmitted by any means whereby faecal material passes through the mouth and reaches the intestinal tract. They may thus be water-borne, carried in drinking water, or water-washed, carried by unwashed fingers which have handled food, cups or spoons. The decision concerning which type of water supply will have most impact on these is not easily made. Suppose, in a particular community, it was shown that diarrhoeal disease was almost entirely water-borne, then the appropriate strategy would clearly be to improve water quality. Suppose, on the other hand, it was known that diarrhoeal diseases were almost always transmitted by direct contact in the home, then it would be appropriate to promote water quantity and availability and to improve domestic hygiene. However, in most, if not all, real situations, these infections will be transmitted both as water-borne and as water-washed diseases, and therefore improvements in both quality and quantity are indicated.

If limitless financial and human resources were available then it would be possible to design water supplies for low income countries so that they provide large volumes of high quality water. However, the size of the global water supply problem is so large and the resources so scarce that it is necessary to design and plan to achieve the best possible impact with the resources available. It will not usually be possible to contemplate the perfect supply, only an improved one. So it is important to be aware that improvements in water *quantity* and *availability* will affect that component of the diarrhoeal disease load which is not water-borne and will also reduce the prevalence of other infections in the water-washed category. Alternatively, improvements in water *quality* will affect the truly water-borne component of diarrhoeal disease and also guinea-worm and perhaps schistosomiasis where these are found.

Diarrhoeal diseases (especially among infants) are a major cause of acute morbidity and mortality throughout developing countries, and much of this diarrhoeal disease is probably in the water-washed rather than the water-borne category. In the water-washed category also, skin and eye infections are a major cause of ill-health and are reduced by increasing the quantity, availability and reliability of the water supply almost irrespective of its quality. Therefore, a general rule can be postulated that all low-income water supplies should strive to bring abundant quantities of water near to or into dwellings throughout the year.

As regards water quality, conventional engineering wisdom has held that all water supplies, except some using groundwater sources, should be treated to improve their quality and that such treatment will pay substantial dividends in improved health. It has further been held that treatment should bring water quality standards up to those recommended by the World Health Organisation as appropriate international water quality standards. For example, WHO claim that, for individual or small community supplies, water should be condemned if it is repeatedly found to contain more than ten coliforms

or one *Escherichia coli* per 100 ml. These standards are far too stringent for hot climates and would lead to the condemnation of the vast majority of existing water supplies in low-income communities. Thus the conventional wisdom, strictly applied, will result in fewer people being supplied.

The addition of any form of treatment process to a supply design will add a major new cost factor and will increase the maintenance problems, and the risks of failure, by an order of magnitude. This is especially true of a treatment process sophisticated enough to produce water which meets WHO quality standards. There is no such thing as a simple or easily maintained treatment system and planners and designers should approach the decisions about treatment and quality with an open mind and not with the prejudgement that treatment is necessary and WHO standards must be guaranteed. There will be circumstances when treatment is appropriate and those when it is not, and in fact, the designer of a water supply is faced with four possible choices: to supply treated water, to supply water without treatment, to supply without treatment apart from 48 hours storage within the water supply system, or to abandon the idea of a supply based on the proposed source. The criteria of "health and sanitary appropriateness" relevant to this choice have been set out by Feachem (1977) in the form of an algorithm, but they may be summarized in simplified form as follows:

**I. Supply without treatment:**

- (a) *if the water is less polluted than a specified limit (defined below) and if there is no schistosomiasis or guinea-worm in the community;*
- (b) *or where water is more polluted than the specified limit, only if a treatment plant cannot be maintained or afforded, if there is no schistosomiasis in the community, if water-borne infections are not prevalent, and if risks due to large numbers using the source are within specified limits.*

**II. Supply without any treatment apart from 48 hours storage:**

*when there is schistosomiasis in the community, but if conditions I(a) or I(b) are otherwise fulfilled.*

**III. Supply with treatment:**

*if the water is more polluted than a specified limit (defined below), and if a treatment plant can be afforded and maintained.*

**IV. Abandon the proposed water source and seek an alternative:**

*if the water is more polluted than the specified limit;  
if water-borne infections are prevalent, and risks are enhanced by large numbers of users, and if a treatment plant cannot be afforded or maintained.*

It will be noted that key criteria refer to the prevalence of water-borne diseases, schistosomiasis and guinea-worm, and also to a specified lower limit of microbiological pollution. This lower limit will need to be defined according to how many people use the water source and what statistical risk of infection is involved—it is unrealistic to apply the same limit to all sources.

It should be noted, too, that in describing pollution limits, reference should be made to the number of *Escherichia coli*, alternatively called "faecal coliforms", found in samples of water. The use of a total coliform index, or most other indicator organisms, would

give quite misleading results if used to measure health hazards in hot climates.

#### *Water treatment techniques*

The second of the four water treatment options listed in the previous paragraph was to store water for 48 hours. Storage in quiescent conditions allows settlement to occur, and it has been shown that extended settlement can reduce the numbers of some micro-organisms; that schistosomiasis cercariae are not able to survive 48 hours storage, and that the numbers of *E. coli* bacteria can often be reduced by 50 per cent or more if storage is extended for two weeks. Storage tanks or ponds should therefore be as large as practicable and should be kept as full as possible. Storage can, however, promote the growth of algae and can allow evaporation to occur. These effects are minimized if tanks or ponds are covered, which also prevents the collection of dust, insects, airborne pollution and small animals. The improvement of quality that results from simple storage cannot be easily predicted, but the amount of equipment and skill is small and the benefits are real.

Filtration through soil is part of the natural cycle and polluted surface water is often substantially purified by percolation through permeable soil before it collects below the surface as groundwater. For this reason, groundwater is normally of much better quality than surface water, but if groundwater is not accessible, the natural process can be utilized to treat surface water by employing sand in a variety of ways to remove suspended matter, cysts, ova, cercariae and often as much as 99 per cent of bacteria. A small practical sand filter can be contained within a vessel the size of a standard 40 gallon oil drum, and is described here as an illustration of the working principle.

When used as a *slow sand filter*, capable of treating about 750 litres per day, the oil drum would have a layer of pea-size gravel about 3 cm deep placed in the bottom, and then would be filled to a depth of about 70 cm with clean sand of about 0.1 to 0.6 mm grade. Water would be admitted at the top at a sufficient rate to form a pool several centimetres deep above the sand surface, and would percolate downwards through the sand. Coarse matter is strained out at the sand surface with such an arrangement, and just below, a biological film forms on the sand grains, which brings about a significant amount of biochemical purification.

After a period in service, the slow sand filter inevitably becomes clogged and must be cleaned; this is one of only two maintenance tasks, the other being to check and adjust the rate of water flow. Both these tasks are simple but must on no account be neglected. Any development programme in which water treatment is employed must strongly emphasize the necessity of reliable and regular maintenance. The actual cleaning procedure consists of first stopping the flow, then draining the filter until the surface of the sand is exposed, and removing a layer about 1 - 3 cm deep from the surface with a scraper. The filter should then be restarted and water run to waste for a short time. The cleaning operation can be repeated as necessary until the depth of sand is reduced to about 50 cm, when fresh or cleaned sand must be provided to restore the filter to its original depth.

A form of small-scale rapid sand filter can be employed when insufficient suitable sand is available for conventional slow sand filters. Sand or crushed rock of 3 - 4 mm grade in layers about 25 cm deep can be used in small upward flow filters. Raw water is introduced below the sand level and allowed to flow upwards. The straining action of the sand is assisted by a form of self-flocculation and also by some biological activity. Filters of this

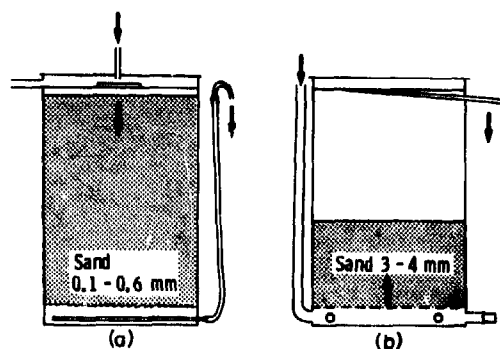

Fig. 4. Sand filters made from 40-gallon oil drums: (a) slow sand filter; (b) rapid upward flow sand filter.

kind can again be built from standard oil drums with an output of 3000 litres per day.

The final safeguard against water-borne disease is disinfection. Slow sand filters may reduce the risks in many cases enough to satisfy local requirements, but as noted in Table 3, when the supply is liable to carry classic water-borne diseases, disinfection of water becomes a health requirement.

Water can, of course, be disinfected by boiling for some minutes, but chlorination is usually cheaper and can be adapted to any scale of plant. However, all methods of chlorination will fail if supplies of chemicals are not reliable, and if they are not stored properly.

These are most important constraints. The duties of plant attendants operating chlorinators are more exacting than for plain filtration. And since there is very little value in spasmodically treating a supply, if reliable attendants and chlorine supplies cannot be obtained, chlorination should not be employed.

In practice, chlorination is most often needed in crowded urban conditions and in the temporary camps for displaced people which rapidly develop after a natural disaster or war. Agencies concerned with disaster relief have developed techniques for emergency chlorination of wells and other supplies which use readily available chemical preparations containing chlorine, such as proprietary disinfectants, commercial bleaches and bleaching powder, and calcium or sodium hypochlorite (Burns and Howard, 1974). The problem of maintaining chlorination over a long period does not occur with these temporary camps, but emergency treatment with such chemicals can greatly reduce what is often a real risk of cholera, typhoid or dysentery on epidemic scale.

#### *Protection of water sources*

Since the cost of a water treatment plant, or the problem of keeping it operating efficiently, may make it unwise to include treatment in a proposed new supply, the protection of the water source from pollution becomes doubly important. Where groundwater from a spring or well is the source, or where rainwater is collected from roofs, this water is often already of high microbiological quality, and with relatively simple measures to prevent faecal material from animals or humans from entering the supply, the need for water treatment may not even arise.

Here we may note that the adaptation of modern technology to the traditional art of



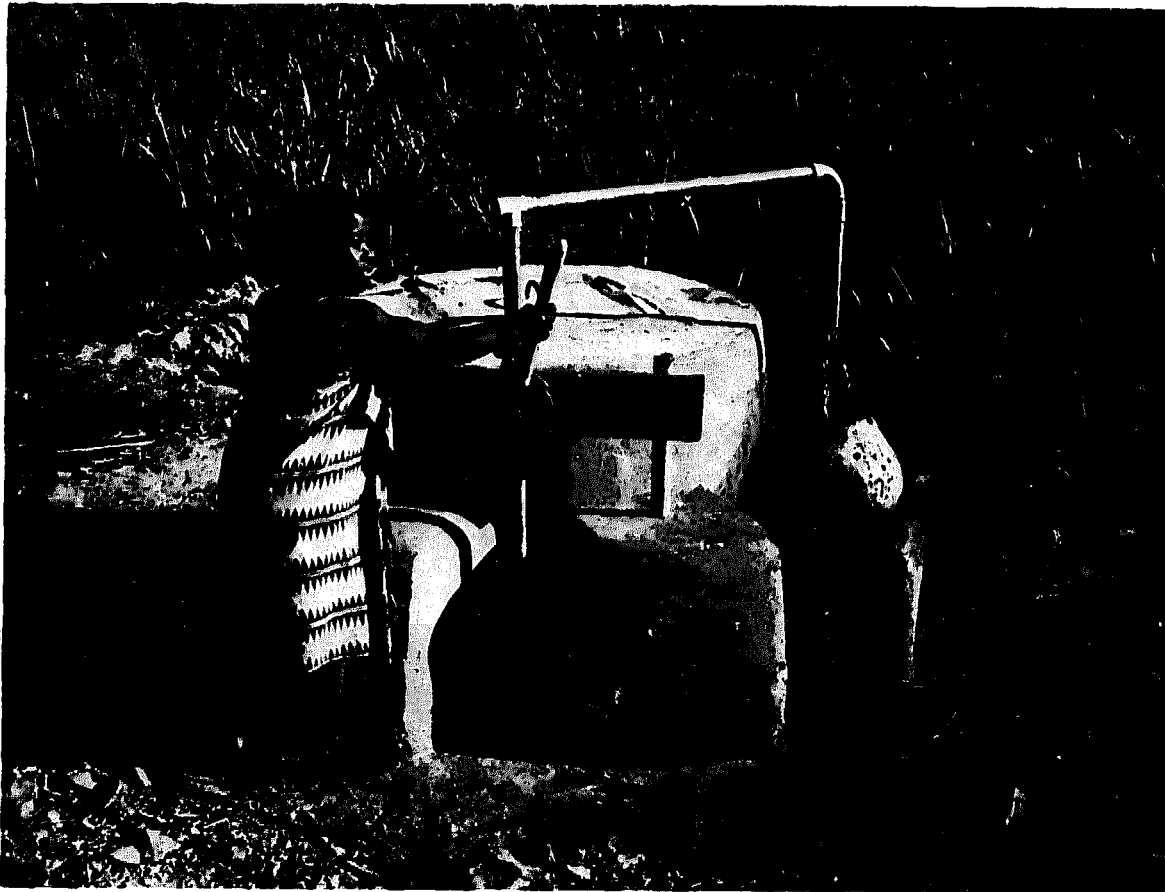

*Fig. 5. Pre-cast concrete rings for lining a well in Bihar, India. (photo: Jim Cranmer/Oxfam.)*

digging wells by hand has greatly improved the extent to which well water can be protected, so that the hand-dug well has been transformed from being a crude hole with an infamous reputation as a source of bacterial and parasitic diseases into a safe structure based on ground engineering principles, and a hygienic, reliable source of water. It is still one of the cheapest methods of providing a small water supply for a rural area where groundwater sources are adequate, and whilst construction is slow and laborious compared with other well construction techniques, it has the advantage of economic appropriateness in areas where labour is plentiful and capital short, and social appropriateness where self-help methods are regarded as an important approach to development.

Among several techniques which ensure also the health and sanitary appropriateness of hand-dug wells are methods for lining the wells with concrete, either using pre-cast concrete rings (Fig. 5), or a thin watertight shell of concrete cast in shuttering which is erected inside the excavation. Concrete rings have the advantage for relatively shallow wells in soft ground where the sides of the well need continuous support, because the diggers work inside the rings, which sink under their own weight as the well is deepened; new rings are added at the top as they become necessary.

In either case, the cylindrical concrete lining of the well is extended above the surface to a height of about 1 metre, so forming a "head wall" around the top of the well. A concrete apron is then laid on the ground surface extending from the head wall to a distance of about 2 metres on all sides. These arrangements are crucial from the point of view of protecting the water source from pollution. The head wall prevents surface wastes from running into the well and helps prevent rubbish and animals from falling in. It is made



*Fig. 6. A shallow well in Tanzania with the top closed to prevent pollution and with access to water only by means of a pump. But semi-rotary pumps at village wells have a poor record for reliability, and this one has been set up with little regard to ergonomics, as can be seen from the stance of the operator. So two out of three criteria for technical appropriateness are not satisfied. (photo: Oxfam).*

thin enough to discourage well users from standing on the top whilst they draw their water; this prevents the larvae of guinea-worm, discharged from the ulcers of infected people, from washing into the well and infecting others. And the concrete apron around the well seals any space between the well lining and the sides of the excavation which could allow dirty surface water to percolate into the well. Drainage of the apron is provided so that spilled water is led away some distance from the well before being discharged into a ditch or onto the land.

Ideally, the protection of the water in the well is completed by sealing the top of the well with a further slab on which is mounted a pump, which then gives the only possible access to the water (Fig. 6). This prevents buckets being lowered from the surface with the attendant risk that they carry dirt of various kinds as well as totally preventing any kind of rubbish from falling in to the well. But as with other equipment mentioned here, the extra cost of even a simple hand-pump, and the difficulty of maintaining it, often makes a solution of this kind unrealistic. Especially where water-washed diseases are prevalent, it is better that people have reliable access to ample quantities of water, rather than allowing insistence on high water quality to cause the supply to be cut off periodically by pump breakdowns.

### **Sanitation**

The benefits to health which should arise from the installation of an improved water supply may often not be fully realized unless there are complementary inputs in the field of sanitation, since inadequate sanitation or sewage treatment plays a part in the transmission of many water-related infections, most notably the water-borne and diarrhoeal diseases, schistosomiasis and hookworm. But sanitation in developing countries has received less attention than water supply, and conventional wisdom about goals, standards and techniques is equally unrealistic. Thus the need for clear criteria of appropriateness here is possibly even more urgent than in relation to water supplies. In particular, the problems of excreta disposal in the high-density, low-income communities on the margins of many developing country cities present a public health problem for which a realistic approach is now long overdue (Feachem, 1976).

The international agency most directly concerned with sanitation made a promising start in 1958 with their monograph *Excreta Disposal for Rural Areas and Small Communities*. This is now in urgent need of up-dating, but in any case does not deal with sanitation in large high-density urban settlements. The later book, *Community Wastewater Collection and Disposal* (1975), does not deal fully with the problems most pressing in developing countries, consisting as it does of a recapitulation of American and European practice in water-borne sanitation. It is thus of limited practical use to those working in poverty stricken situations. What is now urgently required is a manual written out of practical rather than academic experience, on the solution of problems in those developing countries where it has proved impossible to provide new water-borne facilities at a rate which keeps pace with their urban population growth, which may be in excess of 10 per cent each year. No real progress is made in providing sanitation for the many thousands of existing slum dwellers.

Water-borne sanitation is more expensive in terms of capital investment than any alternative; it uses large volumes of water merely to transport wastes along pipes, thereby exacerbating the water resources problems already being experienced in some regions; and it requires more skilled manpower both for construction and maintenance than most alternatives. In addition, the installation of water-borne sewerage systems has in the past frequently also involved the installation of conventional temperate-zone sewage treatment works, which are extremely difficult to maintain, and which in tropical conditions remove faecal bacteria inefficiently (unless chlorination is also undertaken).

In the absence of clear objectives, there has been little impetus for the study of the available choices in urban sanitation, yet many options do exist or could be developed without difficulty. For a city committed to water-borne sewerage, for example, a waste stabilization pond will often be far more appropriate than conventional sewage treatment, or if there is insufficient land for such an installation, aerated lagoons and oxidation ditches are other possibilities.

An example of the replacement of a conventional sewage treatment works by an oxidation ditch is provided by the Kipevu suburb of Mombasa in Kenya. The original treatment works serving this high-density, low-income area had become totally inadequate to deal with the large flows entering it by 1970, and probably earlier. The site was most difficult, with a limited amount of land bounded by a creek on one side. The creek waters are saline and nominally tidal, but the tidal exchange is small in the area adjacent

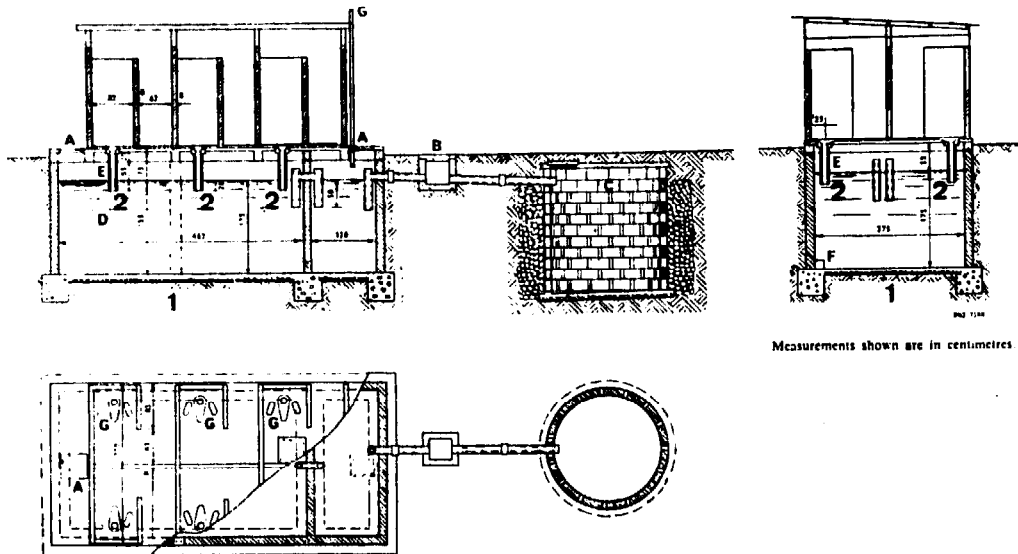

• Reproduced by permission of the United Nations Relief and Works Agency for Palestine Refugees in the Near East.

#### Check list

1. Is the concrete tank of watertight construction ?
  2. Do the drop pipes extend below water outlet level ?
- A = Inspection manholes, 40 × 40 cm  
 B = Inspection box, 40 × 40 cm  
 C = Soakage pit or soakage trench  
 D = Capacity of tank : 22.3 m<sup>3</sup>  
 E = Drop pipe 10.5 cm in diameter  
 F = Opening 15 × 15 cm in partition wall  
 G = Ventilator pipe

*Fig. 7. Design for a communal aqua privy connected to a soakaway. Aqua privies of various types have been tried in several countries, not always with good results—but the system has merit as an alternative to water-borne sewerage, and there is considerable potential for development which could eliminate many of the difficulties currently experienced.*

to the site. The solution chosen was an oxidation ditch running round the site perimeter with the sedimentation tank and sludge drying beds located in the island so formed.

However, a solution to the sanitation problems of low-income urban communities must ultimately depend on a much less capital-intensive technique than water-borne sewerage, and Feachem (1976) points out three general approaches from which to choose:

- (i) *on-site disposal systems*, which include pit latrines, aqua-privies with soakaways, and septic tanks with soakaways;
- (ii) *on-site decomposition systems* include multrum toilets and chemical toilets, and
- (iii) *off-site disposal systems* include labour intensive methods such as bucket latrines, vacuum trucks and other methods involving cartage; there are also aqua-privies with sewers, and at the capital-intensive end of the spectrum, the water-borne sewerage systems already discussed.

These sanitation systems can be in various combinations and of many designs. Some of the possibilities will be unsatisfactory by most standards in their present form, though often there is good potential for development which should no longer be neglected.

**PART II(b): FUNCTIONAL APPROPRIATENESS***Attitudes to engineering design*

Criteria of functional appropriateness are guidelines against which the adequacy of a water supply to meet its immediate objectives can be checked. They have to do with the basic specification and design of the equipment used. So whereas health and sanitary appropriateness is concerned with such choices as whether or not to have a treatment plant, functional appropriateness is about the choice of equipment for the treatment plant (when one is required), the choice of materials and components for all aspects of construction, and the dimension of pipes, tanks and so forth in relation to the volume of water required.

Much of this depends on detailed technical factors which need not detain us here, but it is important to note that in the design of water supplies, the choice of components, materials and dimensions is often governed by codes of practice or by professional conventions which engineers trained in the West too readily take for granted. And not only do these conventions tend to limit the adaptation of design to local needs, but like the WHO standards for water quality, they are suited to the needs of urban water supply in Europe rather than to village water supply in the tropics. Thus codes of practice may lead to the choice of unnecessarily expensive materials or equipment, or may discourage an engineer from improvising when the "correct" components are not available. Every village deserves the best possible engineering design for meeting all the immediate objectives, but given the kind of objectives which seem right for rural water supply, the "best possible" may not always look a good solution when measured against Western codes of practice.

Some engineers are conscious of this dilemma, but feel that if they chose an unorthodox solution to a specific problem and the equipment failed and led to an outbreak of disease, they would carry an undue burden of responsibility; but if they had followed the "correct" design conventions, they would not be blamed (Farrar, 1974). Expatriate engineers working in developing countries are particularly sensitive on this score, and their attitude, however understandable, has been a significant obstacle to the development of low-cost water supplies in a number of African countries.

For example, European water engineers employed in tropical Africa were some years ago unwilling to give their full co-operation to a programme for constructing rainwater catchment tanks at village schools, because it appeared to them that the tanks represented a lowering of standards when compared to usual water supply practice. There was, indeed, a general reluctance within that particular government's Water Section to become involved in any sort of rural water supply, especially if voluntary labour was involved, because "a proper engineering job would be impossible". The main interest of the engineers was urban water supply where conditions were familiar and standards had been established. When community development workers sought assistance from the Water Section with village supplies, they were presented with schemes which seemed inappropriate to local needs and were impossibly expensive (Farrar, 1974).

This is not intended as criticism of the individual engineers concerned, but rather as an illustration of the structures and pressures within which water engineering is commonly practised. Given these structures, and given the attitudes to technical appropriateness enshrined in Western engineering convention, and in the water quality standards and sani-

tation practice advocated so widely, there seems to be no hope whatsoever that the urgent public health problems of the world's rural people can ever be solved. Attitudes to the whole practice of water engineering need to become more flexible; unorthodox routes to simple but effective solutions need to be encouraged; and water quality standards and codes of practice need to become more realistic. We shall return to this question at the end of the paper, with particular reference to the problem of training sufficient skilled manpower to make a significant impact on the world's water supply crisis.

### *The marriage of simple and advanced technologies*

Among the unorthodox routes to effective design which a more realistic sense of technical appropriateness might make possible, there are many which will be achieved by the judicious use of a small element of advanced technology in a context of otherwise simple technology and local materials. Computing techniques, air photography and plastics are all products of high technology which can be used inexpensively but effectively in support of a simple technology. For example, air photographs, often at about 1 : 30,000 scale, are available from the survey authorities in most developing countries, and there is coverage of a surprisingly large proportion of most tropical regions. Such photographs can be used to establish the catchment area and characteristics of streams, to study local geology and to locate possible well sites as well as to serve as maps. They can thus lead to considerable economies in the amount of time and effort devoted to ground surveys before a new water development is planned.

As to the use of modern materials, the scheme for rainwater catchment tanks mentioned above combined polythene sheeting with mud, sand and a little cement to form the tank linings and internal structures. The total amount of polythene was small in terms of weight and cost, but added greatly to the effectiveness with which local materials could be used. Plastic piping has now also become a cheap and effective alternative to more traditional materials, and local manufacture within individual developing countries is already established to a limited extent.

Local research and development of a more realistic, less academic kind than is usual could contribute much to further local adaptations of advanced techniques or materials. Examples include the production of a coagulant aid for water treatment in India using local vegetation as a raw material; the use of discarded glass "carboy" containers as the basis for chlorine dosers in Sudan; and the manufacture by local potters of aqua-privy fittings in Nigeria.

There must be many opportunities for ingenious applications of this nature in almost every country. Research can take place in two directions—from the need to the material (e.g. if filter media are required in an area short of suitable sand, investigate alternative materials), or from the material to the need (e.g. where large quantities of sawmill waste are available, investigate possibilities of conversion to activated charcoal and of using this for water quality improvement).

Other examples of research which should be undertaken include studies of materials, equipment or other items used in the construction or operation of water supplies for which raw materials might be found in non-industrialized countries—examples would include waterworks chemicals, including chloride of lime, alum, quicklime, or substitutes fulfilling the same purposes; also stoneware or concrete piping, sinks, toilet fittings and

storage containers. Work would then be needed on publications giving practical instruction and suggestions on methods of manufacture of each.

A good example of technical appropriateness achieved by a very simple application of sophisticated materials, coupled with a very intelligent return to first principles, is a sanitation unit developed by the British agency, Oxfam. The requirement was for a system of sanitation which could be set up rapidly wherever, in a disaster situation, large numbers of people were brought together for shelter, feeding or to await evacuation from the region. Experience of camps of this kind is that sanitary conditions deteriorate very rapidly because there are often no organized or hygienic places for defaecation—people thus use any site that suits their convenience, and whole camps can quickly be flooded with sewage.

The designers of the Oxfam unit saw that the most basic need in these situations was some means of containing the sewage, and since speed of transport to site and quick erection were also important, it was realized that an easily transported containing unit made of prefabricated parts could be the answer. It is notable that this conclusion was reached as a result of carefully defining the rather unusual Immediate Objectives—and this meant that preconceived solutions were avoided, and a highly specialized and original form of appropriate sanitation was arrived at.

The sanitation unit finally developed is able to deal with the needs of 500 people. It can be transported in a single large packing case, which contains squatting plates and plastic pipework as well as the system of sewage containment. This latter takes the form of air-tight butyl rubber pillow-shaped bags, of which two are normally connected together. The working capacity of each bag is 18,000 litres, and with excreta and pipe-flushing water running into the bags at the rate of 9 litres/person day, two bags together contain 8 days' sewage from 500 people. Not only do the bags contain the sewage, but the anaerobic conditions of storage are an effective form of treatment. By way of proving tests, the sanitation unit was connected to the drains of a cholera hospital in Dacca, Bangladesh, and it was found that in the effluent discharged after eight days' storage, around 99 per cent of most pathogenic organisms had been removed as compared with the original sewage. For example, 99.87 per cent of cholera vibrios had been removed and 98.7 per cent of salmonella bacteria.

Since May 1975, twenty of these packaged sanitation units have been installed in slum clearance and refugee camps in Bangladesh. Although few of the people in the camps had ever seen, let alone used, any form of sanitation, they have accepted the presence of the units and use them in a most responsible manner. Indeed, so well accepted is this form of sanitation, that people who live outside the camps and who are therefore not entitled to use the facilities are found to be regular visitors to the units. This is gratifying in one sense, but it has resulted in an increased load for which the equipment was not designed. The general health of the camp population has been improved noticeably by the containment of the massive daily output of excreta, and most rewarding of all, the dignity and self-respect of the people has increased as a result of having a clean and private place for defaecation.

#### *Human factors in functional appropriateness*

Apart from the functional criteria already mentioned, there are a number of human factors in water supply design whose implications are technical rather than social, and

which therefore can be conveniently discussed under the heading of technical appropriateness. An example is the ergonomics of hand-pump design. Pumping water from a deep well can be hard work, and becomes unnecessarily exhausting if the pump handle is too long or too short, or is placed at the wrong height for the operator's arm muscles to be used efficiently. Few pumps are well designed from this point of view, and in addition, they are usually installed on site by men who may forget that the women or adolescents who will mostly use the pumps require a lower handle position than a man would. Some pumps are also badly placed in relation to well-head structures, again making them difficult to use (Fig. 6). It needs to be emphasized that misuse and damage to pumps often arises because poor ergonomic design makes it difficult to pump with smooth, even strokes of optimum length.

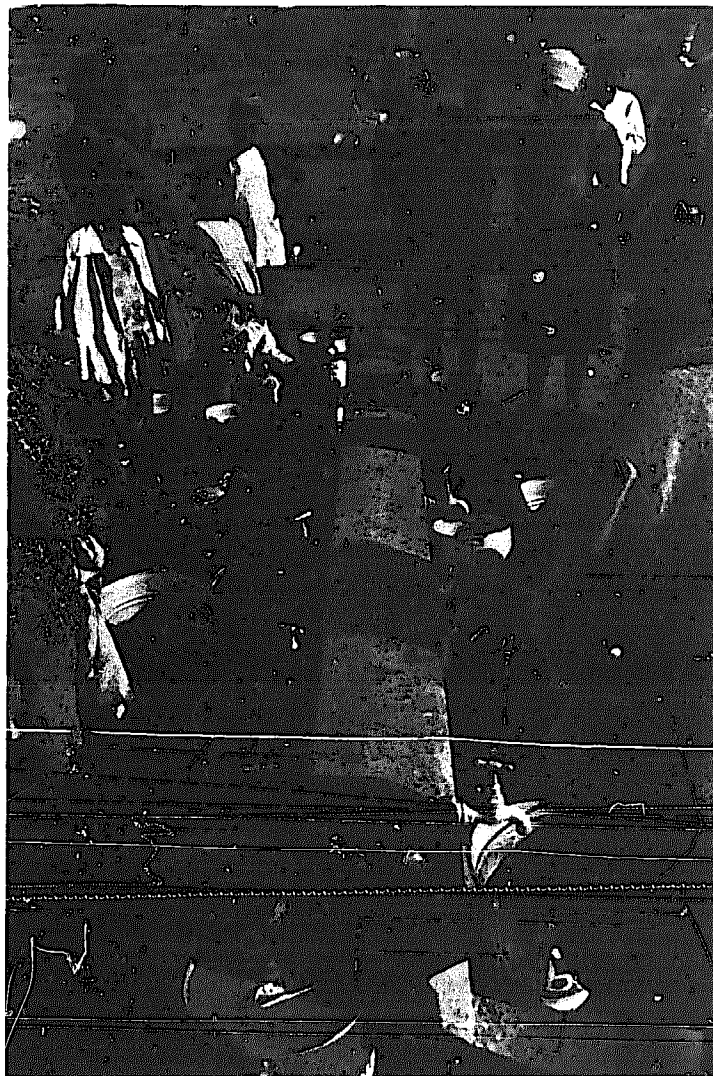

*Fig. 8. Supply systems must be designed to cope with peak demands, which may occur early in the morning or during the evening. These public taps at Mochudi, Botswana, seem barely equal to the task. (photo: Sandy Grant).*



Other human factors which have technical implications include occasional carelessness in leaving water running, or in leaving a tap open and forgetting it if water does not immediately flow. Spring-loaded faucets have been designed to prevent waste of water from this cause—either they require the user to exert a constant pressure to keep the faucet open, or they are designed to allow a specific volume of water to flow (say, 1 litre) before closing automatically.

Peak demand for water in many communities occurs early in the morning or during the evening, or sometimes there are peaks at both times (Fig. 8). The supply system must be designed to cope with this, usually by arranging public standpipes or piped reticulation to draw directly from a storage tank with capacity for up to a full day's consumption. Very obviously also, the capacity of pipes, storage tanks and treatment plant (if any) must be carefully designed in relation to the number of people using the system, the amount of water they are expected to use each day, and the number of additional consumers which may be expected during the life of the system as a result of population growth—small rural water supplies have commonly been designed for a level of water use of around 30 litres/person day.

## **PART II (c): ENVIRONMENTAL APPROPRIATENESS**

### *Environmental constraints on choice of technology*

It is an accident of human history that most industrialized countries are to be found in temperate zones, whereas most (but not all) developing countries have comparatively hot climates. This has meant that where techniques have been transferred from industrialized to developing countries without sufficient thought to the different temperature and associated conditions of sunlight, evaporation and humidity, the use of these techniques has sometimes been inefficient or unsuccessful, or there have been unforeseen environmental penalties, such as increased malaria incidence, or soil erosion. Agriculture, water supply and sanitation are three branches of technology which have been particularly prone to this experience, and in these fields, the assumption that "Western technology is best" still sometimes produces disastrous results for climatic reasons alone.

To design a water supply which is adequate, and indeed, efficient in specific environmental conditions is really an aspect of functional appropriateness. But it raises so many important questions which have too often been neglected that it is desirable to think in terms of a specific set of environmental criteria for the choice of technology. There are two aspects to these criteria:

- (1) there are special problems for the operation of water supplies in hot climates, because:
  - (a) microbiological and chemical processes operate differently, or different organisms are present;
  - (b) low rainfall, long dry season, and high evaporation from open water all create special problems for storage of water:
- (2) any water supply development affects the environment, often slightly—but a number of adverse environmental effects do occur. Environmental appropriateness means choice of technology to minimize such effects.

One topic already mentioned which illustrates the first of these points is the poor performance of conventional European sewage treatment plants in tropical conditions; other techniques such as waste stabilization ponds and oxidation ditches are, in contrast, more efficient in tropical than in temperate climates.

We have also noted that, because of the greater variety of organisms which can live in water and spread disease in the tropics, counts of coliform bacteria, commonly used to measure pollution in Europe, can be very misleading when used in tropical climates. There are large numbers of free-living bacteria in tropical waters which can survive at human body temperatures, and which, in processes involving incubation at this temperature, are indistinguishable from coliform bacteria which have reached the water as a result of pollution. Thus, to make it environmentally appropriate, the technique has had to be modified so that it detects only faecal coliforms.

The effect of water supplies on the environment can be more serious from a health point of view in tropical than in temperate zones simply because of the greater variety of organisms which can cause disease. In a warm climate, there is a greater chance that a new water supply will create an attractive habitat for some unpleasant organism or disease vector. For example, there are many mosquito species, some of which transmit malaria, and others of which are implicated in the spread of yellow fever, filariasis and other infections. The larvae of all species develop in water, but the precise choice of breeding environment varies from species to species. Some breed in temporary puddles, others in cans of water, others around the edges of large lakes where they are shaded by vegetation, and so on. It follows that any water development project is likely to reduce the habitats for some mosquitoes whilst greatly increasing those of others. The effects on disease transmission require some expertise to predict, and special control measures may be needed on large areas of water where blanket coverage with insecticides is not possible. In the small-scale water supplies with which this paper is mainly concerned, the chief hazard will often be from fairly small water bodies such as storage tanks. Such tanks should be covered to deny access to the mosquitoes, and overflow outlets and other openings should be obstructed with zinc gauze.

Environmental changes associated with small water developments can also lead to schistosomiasis, and Bradley (1968) has described instances in Brazil. In the valleys around Rio de Janeiro and Belo Horizonte, small-scale irrigation for market gardens is often developed on a family level. From the point of view of both epidemiology and control, these developments are quite distinct from large irrigation schemes in rural areas. Pollution is common and heavy. It makes the crops grow well so is not avoided. Each garden down the valley uses the waste water from the preceding one so that the rich gardens of the valley bottom are using crude sewage for irrigation. Houses are sited in the middle of the gardens, and other suburban residents contribute to pollution of the stream between market gardens. Watercress is one of the chief crops, and both water-borne bacteria and viruses have ideal conditions for transmission. In the Rio area of Jacarepagua, the snails are of a kind which are very poor hosts for the schistosomes, yet the watercress beds provide such good habitats that densities of thousands of snails per square metre may result, and the transmission of schistosomiasis is maintained. The snail species at Belo Horizonte is a far more efficient host, and over 60 per cent of primary school children in the valleys have the infection.

*Problems of arid and semi-arid areas*

The water resource problems of hot, dry regions of the world deserve as much attention as environmental problems connected with health. Some of these areas, such as the Sahelian zone in Africa, have been given much publicity. Stock-rearing and herding is one of the few productive activities, and the development of water supplies has been strongly influenced by the need to provide water for cattle. But in the past, as more water was made available, the numbers of cattle increased beyond the carrying capacity of the land. Overgrazing then led to the destruction of grass and bush cover, and this in turn led to more rapid and complete run-off of rainwater during the brief wet season. In these circumstances, much water would run away through the river system and be lost to the area; thus a feature of the great drought in Wallo Province, Ethiopia, during 1973 was that, when rain did come late in the season, unprecedented flooding occurred in the Mille River which drains the area, but the land on which the rain fell hardly benefited—in fact, it suffered heavy soil erosion.

The other side of the coin is that when deforestation and overgrazing occurs and rapid run-off ensues, less water percolates through the soil to become groundwater, and wells and springs tend to dry up. Villagers in upland areas of Uttar Pradesh, India, who have been adversely affected by the reduced flow from springs during dry seasons of the year, recently organized demonstrations of “hugging a tree to protect it”, in order to protest against the indiscriminate felling of trees by timber merchants which was the cause of their water shortages.

Apart from low rainfall and rapid run-off during storms, the water supply problems of semi-arid areas are made more acute by the high rate of evaporation experienced in the tropics, which in extreme hot climates can dispose of as much as a 3-metre depth of water in a year. The long dry season demands effective, long-term storage, but the high evaporation rate makes open storage reservoirs exceedingly inefficient. One technique for controlling evaporation is to use reservoirs filled with sand and loose rock. Water is stored in the pores between the particles, and is shielded from evaporation below the surface of the sand.

Small sand-filled dams using this principle have been constructed in semi-arid parts of America and Africa, and have been proposed in Botswana for the supply of drinking water to livestock and people. They can store water for long periods, and provide water during years of total drought, because when the water table is more than a metre below the sand surface, evaporation ceases for all practical purposes. The water is drawn off by a drainage pipe through the dam wall, or by a well dug into the sand (Fig. 9), and having been filtered through sand, does not usually require any treatment.

The technique used to create a sand-filled reservoir of this kind demonstrates an admirable appropriateness to environmental conditions—flood waters in semi-arid zones often carry a high sediment load, because there is little vegetation to prevent erosion of the soil. So when the dam wall for a reservoir of this kind is built in a river-bed during the dry season, the necessary sand and gravel will be deposited behind it by flood water when the rains come. Normally, the material carried by flood water is roughly 75 per cent mud with only 25 per cent sand and gravel. To ensure that only sand and gravel are deposited, the dam wall is built first to a height of only 2 m, and is subsequently heightened in stages as the sand deposit builds up. This enables flood waters to overflow the wall,

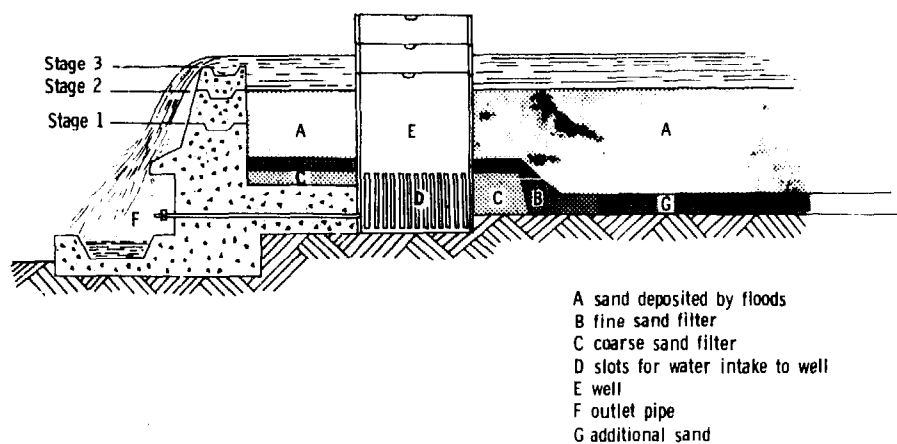

Fig. 9. The principle of the sand fill dam (not to scale).

taking most of the finer material with them and depositing only heavy particles. Each stage is added as the space behind the wall fills with sand (which may require the whole of the wet season), until, after 4 or 5 years, the full operating height of 6 - 12 m is reached.

Of great potential value in arid and semi-arid zones, this technique is environmentally appropriate only to those particular regions where floods carry a large sediment load, and where the sediment includes significant amounts of sand or gravel. Most water conservation techniques, indeed, have to be specifically appropriate to particular environments. Another example is the use of furrows and low bunds to encourage infiltration of run-off water into the subsoil and to prevent erosion. The technique is widely used in different versions, often with bunds graded so as to drop steadily below a datum contour, and direct surplus water across a hillside and into a water course. On the gently sloping valley-bottoms known as "dambos" or "mbugas" in central and east Africa, however, where climatic conditions are generally moist, it may be advantageous to align furrows precisely *along* the contour, and this has led to experiments in Zambia with "contour seepage furrows", (Hindson, 1962). The value of the extra water which could be made to infiltrate the soil in this way is evident from the fact that in southern Malawi, 80 per cent of the rural population gets its water from wells dug into this type of valley floor.

Two other water conservation techniques are worth mentioning because data is available on their social appropriateness for village water supply, as well as concerning their environmental appropriateness. These are *percolation dams* as used traditionally in India and more recently in the Sahelian zone of Africa; and *rainwater catchment tanks* as introduced by the Intermediate Technology Development Group in Botswana, Swaziland and Brazil.

#### *Percolation dams*

The principle of the percolation dam is to construct a bund or small dam on permeable soil, such that water trapped behind it percolates into the subsoil and so into any underlying aquifer. This water is then effectively stored underground and protected from evaporation loss. Access to it is obtained by digging wells, which may be located immediately next to the downstream face of the dam, or as much a mile away down the valley. The dams are usually built across water-courses or valleys to intercept flood water during

storms, and the technique is simply an aspect of what is known as "groundwater recharge".

Sand-fill dams like those just described can be used for this purpose with particular advantage, because they allow most of the finer sediments in flood water to be carried away with the overflow. Thus, the clogging of aquifers by silt-laden water which can readily occur with recharge systems is avoided.

However, this approach is not used in India, where one typical scheme, proposed for Machohalli village, near Bangalore, was based on a conventional earth dam, 200 m long and of 7 m maximum height. The engineer responsible estimated that existing wells up to 2 km downstream from the dam would benefit from its construction, and he pointed out that this was an "old Indian method, three or four hundred years old". It is significant that this dam was not built because the large earthworks proposed were beyond the resources of the local community. But the historical precedent may be relevant in view of the doubts expressed by Western engineers about the problems of silt in such dams. A historical study of India's long experience with percolation dams would probably reveal appropriate techniques for reducing these effects.

During the drought years 1967 - 70, some forty percolation dams were constructed by manual labour in a populous area of Maharashtra state. Food was very short, and payment for labour with American donated grain on a food-for-work basis attracted from 100 to as many as 500 people to work on each dam site (Fig. 10). The dams were located upstream of areas where domestic and irrigation wells had run dry, and after rain had fallen, water tables within limited areas rose so that many wells could be brought back into use. The technique showed evidence of being socially appropriate in that it aroused considerable enthusiasm among the people, and encouraged a greater degree of co-operation between them than is common in that region. One person said: "we as a community have now proven that if we get together and work in harmony, forgetting our differences, including caste, we can get things done that we would have thought impossible a year ago." (Oxfam, 1975).

In Otterthotti, in the Karnataka state of India, a series of small-scale water conservation works was put in hand during the same drought. They included fifteen small dams, and also field bunds which retain more of the rainfall on farm land, so that crops benefit and there is also more percolation into the ground. The village had traditionally relied on wells for domestic water and irrigation. There were around 100 of these, of which most dried up during the drought. The effect of the percolation dams was to ensure that when a new drought occurred in 1973 - 4, after 2 years of good rainfall, water tables remained at a high level in the wells, and intensive irrigation of rice and other crops could continue.

There was evidently no problem at Otterthotti about the earthworks requiring more labour than the village could readily provide. Although some farmers "feel the works are very essential, but ... are not coming forward to participate", up to 100 people were willing to work voluntarily on individual sites, moving soil with picks, shovels and baskets, and helping to build a stone facing on some dams (Fig. 11). When similar percolation dams were introduced in Upper Volta, however, it was assumed that a voluntary labour force of 200 or more could be mustered, and large embankments were planned, typically 200 m long and up to 4 m in maximum height. In fact, only 50 to 100 people worked regularly, and got discouraged because of their slow progress. The dams had then to be

completed using hired tractors. The lesson, however, had been learned, and plans for new dams involved a reduction in scale, with embankments now only 30 - 40 m long and about 2 m high. Benefits from the initial large dams are already apparent, however, and villagers are going ahead with construction of wells downstream from the embankments.

It will be observed that the need for these schemes to be socially appropriate has led to



*Fig. 10. Percolation dam being built in the Maharashtra state of India, December 1969. Construction was by manual labour paid for on a food-for-work basis.*

a scaling down of the size of the earthworks in some cases. Because percolation dams are a traditional technique which has not been given much attention by the engineering profession, the technical efficiency of such works—their technical appropriateness—has rarely been precisely evaluated. Performance must vary greatly with local geological conditions and with any tendency of silt in dams to reduce their effectiveness. So it is not clear whether the small dams dictated by the need for social appropriateness are proportionately less efficient than larger dams. At Otterthotti, the intuitive judgement was that a series of smaller dams at different points achieve more rapid percolation of surface water to the aquifer.

#### *Catchment tanks and rainwater harvesting*

An alternative approach to the collection and storage of the run-off water which flows over the ground during storms, and one which is better suited to small-scale application, is the “harvesting” of rainwater as it runs off natural ground surfaces, roads, school playgrounds and off roofs or specially prepared catchment surfaces. For the individual householder, the collection of rainwater from his house roof can be an especially attractive option, because the water is usually very clean, and the water can be stored in a large tank standing conveniently close to the house.

Only limited volumes of water can be obtained this way, however—tanks intended for small houses in semi-arid areas seldom exceed 10,000 litres capacity—and if larger volumes of water are required, a catchment tank “harvesting” water from the ground surface will be needed. Figure 12 illustrates the principle of both types of catchment tank, and



*Fig. 11. Stone-faced earth dam for water conservation under construction at Otterthotti, in the Karnataka state of India. (photo: Father Godest).*

indicates how the two may be used together, with overflow from the roof tank occasionally contributing water to the excavated tank (Farrar, 1974). A householder using the two types of tank together in this way (as one has been observed to do in Botswana) would tend to draw his drinking water from the roof tank, because this is the cleanest source, and would use the second tank as a source for washing water or for other uses where high quality was not essential.

Another way of harvesting rainwater in conditions where the ground is permeable and most of the rain soaks in with little natural run-off is to make an artificial catchment, possibly by laying concrete or asphalt to form a smooth impermeable surface on the ground, possibly by chemical treatment of soil surface, or even by laying polythene or some other type of sheeting on the ground surface (Maddocks, 1975). Large scale applications of some of these methods are in use in Gibraltar and Jamaica, both in situations where permeable rock limits natural run-off. These are unusual instances where rainwater harvesting is one of very few options open for public water supply, and in both instances, the consumption from the somewhat limited public supply so obtained is kept within bounds to a significant degree by numerous privately-owned catchment tanks which collect rainwater from individual house roofs. In these two cases it is peculiar geological and geographical conditions which make rainwater harvesting environmentally

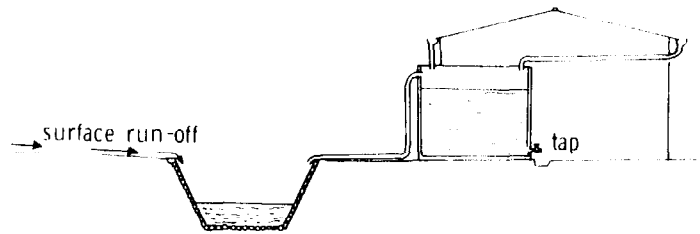

*Fig. 12. Rainwater catchment from roof and ground surface. With precautions to prevent dust and bird droppings being washed off the roof into the tank, and with a suitable cover, the roof tank can provide high quality water suitable for drinking, while the excavated tank may provide water suitable for wating or watering gardens (after Farrar, 1974).*

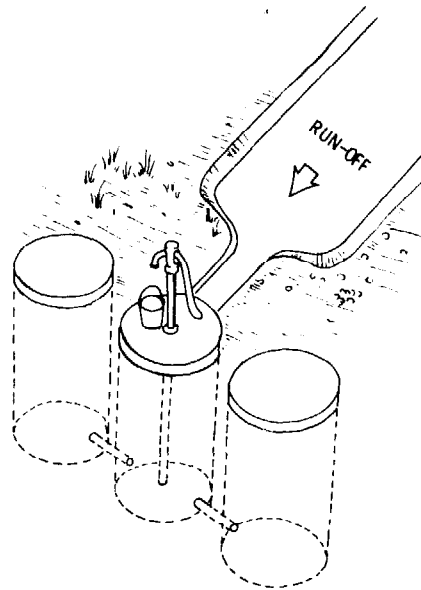

*Fig. 13. Linked cylindrical tanks for surface catchment, used with a concrete catchment surface. The tanks are excavated in the ground, lined with brick or stone, then plastered with cement to make them water-tight (after a drawing by the Christian Care organization, Umtali).*



appropriate, rather than the general shortage of water experienced in arid and semi-arid regions.

Concrete catchment surfaces are usually too expensive for large-scale use, but may be feasible on a small scale, as with one water harvester design from southern Africa which also incorporates a tank constructed in the form of a shallow well covered by a concrete slab (Fig. 13). If one well has insufficient capacity, others can be excavated beside it, and can be connected together by pipes so that water can be abstracted by means of a single pump.

Catchment tanks excavated in the ground can be lined with any impermeable material to make them watertight, but as previously mentioned, one particularly novel form of lining uses polythene sheeting and mud to provide the waterproof membrane. There are also various ways of covering tanks to prevent evaporation; one of the most unusual is to build hollow domed structures inside the catchment tank—a backfill of sand is then

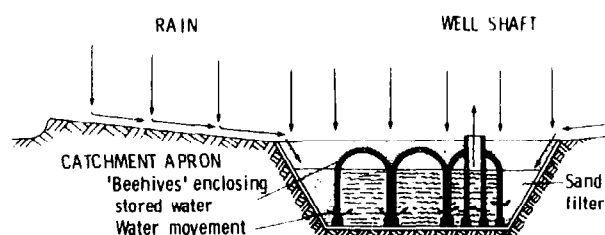

Fig. 14. Cross-sectional view of a "beehive" tank. The domed "beehive" structures are built from polythene sandbags containing a small amount of cement; they set hard after being placed in the structure, having thus taken up the shape necessary to bond into it. For details, see ITDG (1969).

spread on top of the domes and levelled up with the ground surface (Fig. 14). Water entering the tanks is thus filtered through the sand and stored inside the domed structures and in the sand fill between them. The beehive structures are built, not of brick, but of lengths of polythene tube filled with a weak cement mixture and sealed at the ends. These are laid in place before the cement mixture sets, and readily take up the shapes required, nesting securely against the corresponding members below them. The sides of the polythene-lined tanks are also supported by the use of these cement/polythene sausages.

Tanks of this kind are limited in size—the largest of a series built in Botswana and Swaziland had a capacity of 90,000 litres—but do provide a very neat solution to certain fairly specialized water supply problems in semi-arid areas.

Tanks of the "beehive" type have now been built in Sudan, Botswana, Swaziland, Brazil and Jamaica, with perhaps the largest number in Swaziland. These were built during 1970 - 73 by the government, with technical assistance from the Intermediate Technology Development Group, and they were mostly located at schools to provide drinking water for use in school meals programmes.

It was striking that progress on the building of the Swaziland tanks was very slow, and some were never completed. There were many reasons for this, but it seemed significant that people consistently balked at the amount of labour they were being asked to contribute voluntarily as part of the self-help programme. Partly because so much of the

volume is occupied by sand and by the "beehives", the amount of digging is large in relation to the storage capacity. The tanks were undoubtedly technically appropriate in the dry climatic conditions in which they were used, both in terms of functional and environmental appropriateness, but the slow progress with construction by people who were meant to benefit seems to imply that the tanks were not socially appropriate.

### **PART III: SOCIALLY APPROPRIATE WATER SUPPLIES AT VILLAGE LEVEL**

#### *Water use patterns*

Although we earlier defined a whole hierarchy of objectives and goals for water supply development, two main goals stood out above all others—one was the improvement of health, and the other was the saving in time and energy which would result from people

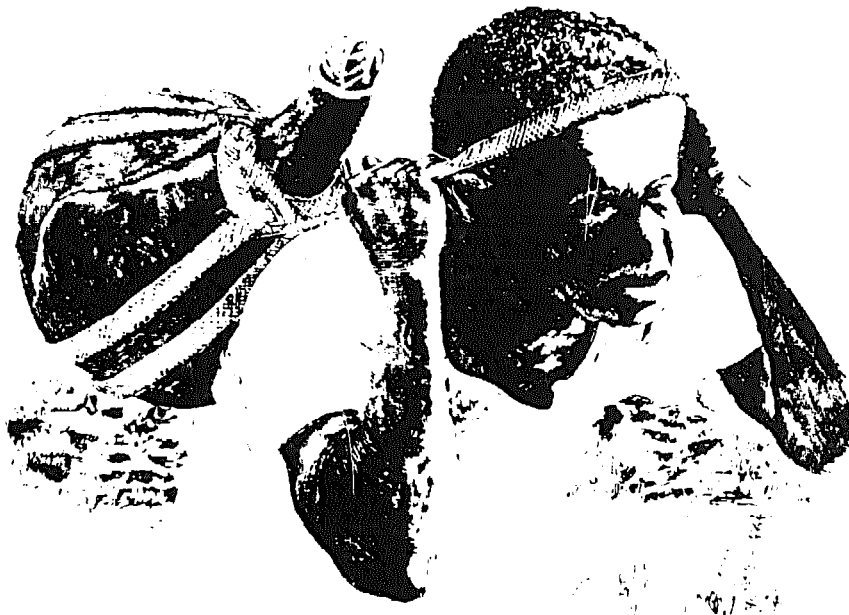

*Fig. 15. Water carrying patterns in East Africa: a woman with a traditional type of water container at Mukaa, Kenya (illustration by Tag Ahmed).*

having water nearer their homes, so that the work involved in carrying water home would be reduced.

Of the several aspects of village-level organization which need to be considered under the heading of "socially appropriate water supplies", organization of water carrying and the use of water is the simplest, but also one of the most important in relation to the general objectives of water supply improvement. It is a simple aspect of social appropriateness because in general, each family makes its own arrangements and no significant community organization is necessary. Throughout the world, it is mostly the women of the household who are responsible for carrying water, often helped by older children (Fig. 15 and 16). Where large containers are available, such as the standard 40-gallon oil drum, the men may sometimes transport these to the water source on a donkey-cart or other vehicle and bring back larger quantities than the 14 - 16 litres which a woman can carry on one journey. In addition, better-off members of a community will sometimes



*Fig. 16. Metal containers, either buckets or former oil cans of various kinds are now frequently used for water carrying, as in this instance at Mutwot, Kenya (illustration by Tag Ahmed).*

pay a neighbour with a cart to fetch water, and in larger communities and towns, there are full-time water carriers from whom water can be bought.

Apart from the question of carrying the water needed for use in the home, people in many communities take clothes to the water source to wash them there, or sometimes go to the water source when they want to wash themselves. There may be favourite places by streams or water-holes where the women gather at regular times to wash clothes and enjoy one another's company. Sometimes it is desirable for a new water supply to make provision for a similar communal laundry facility so that this custom can continue.

Simple village water supplies typically provide standpipes close to people's homes and this reduces but does not eliminate the water-carrying journey; in densely populated areas, it is more often possible to provide a tap inside individual homes. The questions which need to be asked in relation to the objectives of the supply improvement are: how much time and energy is saved through the reduced water carrying, and does the shorter journey to the water source encourage people to use more water? If they do use more water, is this a sufficient increase to benefit health through better hygiene? An extensive survey of water use in East Africa (White *et al.*, 1972) has shown that water carriers in rural areas spend a mean time of 46 min/day collecting water, though in some communities, over 4 hours per day are required. It is clear, therefore, that in regions where a substantial effort

is required to collect water, savings in time and energy are important benefits which water supply improvement should seek to attain—though occasionally, these are benefits in which some members of local communities (usually the men) show little interest.

The impact of a sequence of improvements over a number of years was gauged in one detailed survey, of a community in the Lowveld region of Swaziland, aided by a series of air photographs, extending back in date to 1947. It was possible to estimate that between the latter date and 1972 the average distance from homes to water sources had been reduced from 2.6 km to 1.4 km, while the maximum distance had dropped from 6.5 km to 4.0 km.

The water supply improvements responsible for this change were the construction of several small earth dams; but there had also been considerable changes in population and settlement pattern, which meant that some people had moved nearer to water. In 1972, a further improvement in water supply was being planned, consisting of a piped water supply to a standpipe in the village nucleus and a supply to the clinic and school. But because houses were not closely grouped around the village nucleus, the piped supply would reduce the average water-carrying distance only from 1.4 to 1.0 km. The average amount of water used in the home in 1972 was 5 litres/person day for the majority, though a group of better-off people, some of whom paid to have their water delivered, were using an average of 13 litres/person day. The piped water supply, completed in 1974, has not been followed up with a new survey of consumption, but it would probably be found that water-carrying journeys of 1.0 km are still too far for consumption to be greatly increased.

The question then arises, how much water should be used if the health benefits from improved hygiene are to be obtained, and if the incidence of water-washed disease is to be reduced? The only precise studies relating volume of water used to disease were made in parts of California where dysentery caused by *Shigella* was very prevalent in the 1950s among families of farm labourers. These studies showed that, although all types of sanitary improvement tended to reduce the prevalence of *Shigella*, the big reduction came when water was available inside the house, rather than nearby outside. Observation of people's behaviour in East Africa suggests that once water is available within a mile (1.6 km) of the home, water use does not significantly increase when this distance is reduced, until the point is reached where a tap can be provided within each house—then consumption may rapidly rise into the range 30 - 100 litres/person day (Bradley, 1974).

A shower, or some similar washing facility, also seems to improve health. There is, however, no good evidence that once each family has a tap and shower, further increases in water supply facilities appreciably affect health. In all instances, though, when water supplies are improved in isolation without complementary inputs, the improvements have not always produced the health benefits hoped for. In the absence of education, the supply may be misused and the opportunities for improved hygiene may be neglected. The same need for complementary inputs is apparent when one considers the time and energy saved in carrying water, and how this time may otherwise be used. There may be opportunities for developing women's clubs (which can have a valuable educational impact), or handicraft schemes or vegetable gardens. Whether the time and energy saved from the water carrying tasks are devoted to any of these depends very much on what community development or extension work follows on after the installation of the new supply.

Designing a water supply so that changes in people's consumption and water use behaviour leads to the fullest benefit in terms of time/energy saving and hygiene is one aspect of what is referred to in Table 2 as *consumer appropriateness*. Other aspects of this relate to listening to the prospective consumers, and taking note of what they say about their needs—some, as already mentioned, may ask for communal laundry facilities, others may want an animal drinking trough. There will also be opinions about the siting of public standpipes and payments for individual house connections (where these are possible).

#### *Social appropriateness and community involvement*

If one's training predisposes one to look only at the technical aspects of water supply, as is the case with the present authors, then a useful corrective can be to work on water projects which are planned and implemented in full collaboration with the community being served. One is then concerned not only with how well the equipment functions (its technical appropriateness) but also with the community's attitude to the equipment and the degree to which local skills can be mobilized to help construct and maintain the water supply.

There are two tests of whether a community development water project has been successful in this respect. One is, to see whether the people care for their new water supply and ensure that it is properly maintained. The other test is whether they go on to suggest and initiate other projects when the water supply is complete. This last happened in some community water projects we know, where people on their own initiative have started vegetable gardens irrigated by overflow from the domestic water system, where they have built earthworks to control soil erosion, and where, in one case, they have built a new road. It was clear that the experience of constructing the water supply had made a considerable educational impact, awakening people's interest in other forms of development.

These two tests of the success of a community development water project are the criteria which were described in Table 2 as *maintenance appropriateness* and *educational appropriateness*. And even where it is not thought desirable to develop water supplies within a community development context, it is important that they are cared for rather than misused by consumers; that they are not subject to vandalism; and that they have some educational impact, if only in the field of hygiene. Thus it is always important that water supply improvements should be appropriate in these two ways, and this depends so much on the response of the people, that the key to appropriateness is not just the technology used, but the way it is introduced and the amount of consultation involved in the planning of the project. It is relevant to consider how the project was initiated: did the villagers ask for it, and does it answer their "felt needs" and stated preferences? Was it suggested by an extension worker or official who had direct experience of the needs of the community? Or did it evolve from a development plan worked out in a distant office? It is important also to consider the planning process: was there consultation between those who designed the system and the villagers? Was the design flexible enough to incorporate specific suggestions made by the villagers about standpipe sites, animal drinking troughs and so on? Were village meetings held, or was a committee elected to discuss the plan? The answers to questions such as these provide the criteria which Table 2 refers to as *community appropriateness*.

In a recent project in Tigre Province, Ethiopia, where villagers were mobilized for digging their own wells, the pattern of consultation between the British technician who

designed the wells and the villagers was for an initial discussion to be held early on a Sunday morning, after a church service which had begun before dawn. The need for a well was discussed with the village elders, possible sites were inspected and considered in relation to their convenience for householders and the probability of striking water. The agreement of the owner to hand over the site and also to permit access had also to be arranged.

There were many difficulties to be overcome, including objections from a village priest concerned about "holy water", and from a local land-owner who wanted the well sited mainly for his own family's advantage. Then, too, there was the people's experience of "food-for-work" during the famine of a few months earlier, and some villagers now wanted this for digging their own wells, despite having had a good harvest. The project refused to give food, however, and tried to encourage the villagers instead to feel pride in standing on their own feet and providing the necessary labour force. The hope was that if the people were actively involved, they would be able, for ever afterwards, to maintain and service their installations. And in most villages, at least an initial success has been achieved. In a typical case, a village set a rota of men to work alongside one or two full-time employees of the project. Within 15 months, a dozen or more wells have been dug, some of them over 20 m deep, and they have successfully served people through a full dry season.

The next step was to provide the wells with hand-pumps, so that containers which might carry pollution would no longer need to be lowered into the wells to draw water. A prototype hand-pump was made in the project workshop, using a short length of plastic pipe, carved pieces of wood and leather, and some piping and rodding. Shortly afterwards, village men had imitated the design and were making and installing these very basic pumps themselves. Having learned by this experience, these villagers should now have the ability to keep the pumps working and in repair. The pumps were of a design which could be used equally well for shallow wells and deep wells, and they are so basic that they may be regarded as even more simple and fundamental than "appropriate technology" as it is usually encountered.

This project was carried out during 1975 and 1976, so it is too early to say whether it will prove to have been socially appropriate in the long term, though its short-term success is certainly encouraging. Enough time has passed, however, to make possible the evaluation of other projects of which we have experience, including the catchment tank schemes previously mentioned which were located in semi-arid climatic zones in Botswana and in the very dry Lowveld region of Swaziland. Despite their impressive environmental appropriateness, these tanks did not excite much enthusiasm in some of the villages where they were built, and many were not maintained after completion. It is possible to see with hindsight that there were several criteria of social appropriateness which they did not meet.

One difficulty is that the "beehive" type of catchment tank (Fig. 14) cannot be made large enough to provide the water supply for a whole village, yet it is too elaborate and costly for more than the occasional individual householder to build for himself. Thus the majority of these tanks were built at schools, so that the parents of children at the school could be expected to contribute to construction though not using the tank themselves. The simpler type of open catchment tank (like that on the left of Fig. 12) seemed suitable for the collection and storage of irrigation water for school vegetable plots, and was used as

such in Botswana, while the "beehive" tanks gave a good source of water for cooking and drinking in Swaziland schools.

Much of the problem in these programmes was that the provision of water at schools was not relevant to any urgently felt need of the local people—it did not answer any of their day-to-day worries. And when on top of that, the amount of labour involved in constructing the tanks (especially the "beehive" ones) proved to be very great, it is understandable that work progressed slowly and some tanks were never completed.

Not all the tanks were failures, though, and it was perhaps significant that two of the most effective ones in Botswana had been built privately by householders prosperous enough to afford them; this seemed the most socially appropriate application of the technique. Another effective tank was at a school in Swaziland with a keen (and relatively permanent) headmistress who had put considerable effort into maintenance. Other tanks successfully serving a useful purpose were those of the "beehive" type whose superior technical appropriateness had enabled them to survive considerable neglect. There has also been good experience of tanks constructed on this principle in the semi-arid Piaui region of north-east Brazil.

Reaction of villagers to the work involved in these projects suggests that there is a limiting relationship between the amount of self-help labour people will contribute, and the benefits they think will emerge. Estimates of the number of man-hours needed for construction indicate that the "beehive" tank demands two or three times as much work to create 1000 litres storage capacity than any other comparable tank. Since villagers were probably not all convinced of the benefits of building catchment tanks at the schools, they were doubly unhappy about the work involved.

In an earlier part of this paper, mention was made of dams and other conservation works which required very much more earth-moving than these tanks, and for which a labour force of up to 500 people was mustered in one populous area in India. In these instances, the work was not entirely unpaid, because the drought conditions which had awakened interest in water conservation measures also produced food aid and relief funds from foreign sources which were used to pay for the labour involved. But perhaps the most instructive example of dam construction cited was the project in Upper Volta where no payment was given and villagers worked entirely voluntarily. In one instance where a dam was left incomplete because the people were not convinced of its value, they resumed work after one rainy season had demonstrated the benefits arising from other dams in the same area.

Not everybody will agree that the provision of water supplies should depend on self-help to such a degree that large earthworks are built by voluntary labour, but in countries where this policy is followed, it is clear that the relationship between the benefits of the project and the amount of labour people are asked to contribute is yet another important criterion of social appropriateness. Choice of technology must be influenced by considerations such as these, and the stress on labour-intensive techniques must not be carried to the point where people's willingness to help themselves in this way is frustrated by an excessive and unrealistic work load. It is also necessary to take heed of the potential disbenefits which may result from a self-help policy. In particular, self-help may lead to a poor standard of construction, and therefore a greater frequency of breakdown, and to an inefficient allocation of the central government inputs of money, skilled personnel,

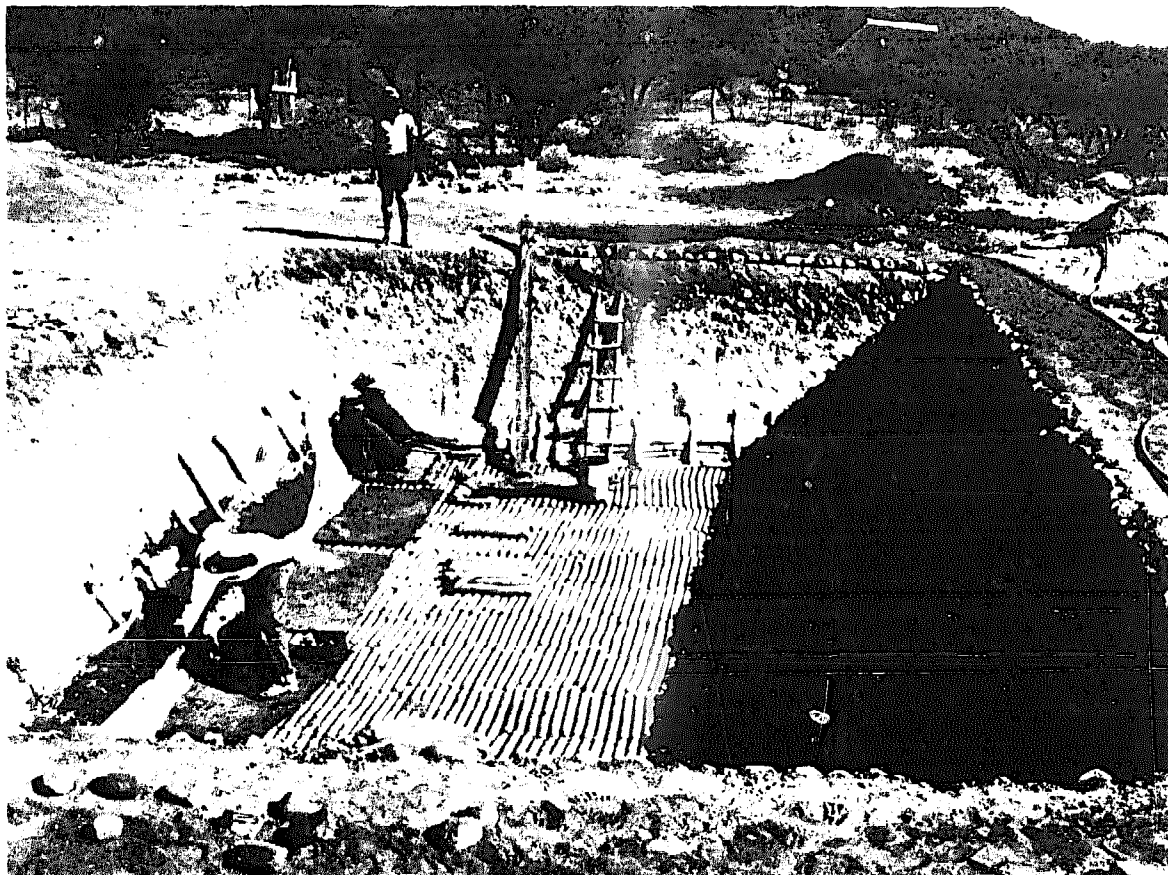

*Fig. 17. A rainwater catchment tank under construction at Serowe, Botswana. The tanks is being lined with polythene sheeting to make it water-tight, and the sheeting is then protected by lengths of polythene tube filled with a weak cement mixture and sealed at the ends. (photo: Ray Parnell/Oxfam).*

tools and machinery. These may be significant arguments against a self-help approach and these need to be faced and overcome rather than buried in community development ideology.

#### *Social appropriateness of individual water improvements*

The suggestion that the "beehive" type of catchment tank may be more appropriate to individual than to community water development needs further examination. One implication may possibly be that its application is limited to areas that are so sparsely populated that the possibility of a community water supply does not exist, so that individual families, or groups of two or three families living close together, have to be provided with separate small supplies of their own—excavating and constructing the tanks themselves with only limited outside help.

However, the principle of individual families providing themselves with private supplies might be relevant in more populous areas too. Where land is not available for ground surface catchments and "beehive" tanks, the collection of water from roofs is always possible, provided that the roofs are made of hard, impermeable materials.

Roof tanks can rarely provide all of a family's water, but they can usefully reduce demand on the public supply where this is inadequate or where water resources are scarce. And in areas where alternative sources of water are polluted, roof tanks give a relatively



clean and safe supply, provided that precautions are taken against dirt and bird droppings on roofs.

In parts of Jamaica, when public supplies from large rainwater catchment systems failed during a drought, water remaining in roof tanks on private houses proved sufficient, when shared out, to meet basic needs until the drought was over. Another community with very restricted water resources is Gibraltar, where, in order to relieve pressure on public supplies, all houses are expected to have roof tanks. (This is enforced by building regulations when a new house is built).

A country wishing to make a rapid impact on its water supply problems could relieve pressure on its existing supplies in this way, and at the same time mobilize private resources on a large scale by encouraging the construction of individual roof tanks. A small subsidy on standard equipment plus an advisory service for householders wishing to make provision for themselves could be very effective. But White *et al.* (1972) remark: "The household interested in improving its individual supply receives almost no information or technical assistance."

The range of materials and techniques available for roof catchment tanks includes galvanized steel tanks which can be purchased ready-made throughout most of the world; cheaper metal frames or containers with PVC plastic linings; ferrocement tanks, such as those developed for intermediate technology application in Thailand and in central Africa; and tanks built of brick, stone or concrete blocks, and waterproofed by plastering the inside. Tanks of the latter type have been quite widely used—e.g. in Jamaica, Ghana and Botswana—but the experience everywhere is that galvanized steel tanks are very much more expensive than any of these other possibilities.

#### *Village piped water*

If rainwater catchment systems have yet to be fully exploited because of their uncertain social appropriateness in medium-scale applications, and reluctance to encourage small-scale use for private and individual supplies, the issues surrounding village piped water supplies are possibly more straight forward. Some of the best piped water schemes known to us are to be found in Lesotho, where a larger proportion of the rural population is said to have access to piped water than in any other African country. Numerous springs on the hillsides of this mountainous territory make it relatively easy to find a source for many villages from which water can be piped by gravity. The spring chosen for a supply is enclosed in a concrete structure from which a pipe leads down the hillside to a storage tank located at an elevated point in the village; this feeds the public taps where the people come to draw water. In a typical case, the villagers would previously have had to collect water from polluted sources in or near the village.

The water supplies constructed on this principle are not simply a matter of the convenient hydrology of the country, however. Much credit is also due to the community development department of the Lesotho government and the type of village organization which they have fostered. Any village wanting a piped water supply must first have its own development committee, which then takes responsibility for negotiating details of the project with the government, collecting money contributions and organizing a voluntary labour force to dig trenches for pipes and so on (Fig. 18).

The village committees are supposed to continue to function after the water project is



*Fig. 18. Volunteers at work on the pipeline bringing water from a spring to a village in Lesotho*

complete, because there is still a need to arrange for the water system to be maintained, and sometimes for it to be developed, e.g. by arranging the irrigation of vegetable gardens, or by disseminating knowledge of the hygiene measures necessary if health is to benefit from the new supply.

In some cases, the committee system has worked well. An official of one of the agencies which gave financial support described how he had visited several of the projects in order to see, "what effect, if any, the schemes have had on the villagers themselves... In every project, the villagers I spoke to talked of the scheme as being 'theirs', and I was frequently surprised at the trouble they had taken in repairing any broken pipes or taps—often involving the raising of money to pay for bus fares and spare parts so that a villager could travel to the nearest town to purchase the parts required". Long-term experience, however, has not been so good; it appears that the village committees have not had a sufficiently strong legal status, and difficulties have been increased by the absence of local government structures. These factors combined with a lack of government policy on



Fig. 19. Storage tanks for a village water supply in Lesotho (photo: Associated Newspapers Group Ltd.)

precisely *who* is supposed to be responsible for maintenance have combined to make maintenance in many villages sporadic or non-existent. The government makes no formal arrangements for maintenance responsibility when it completes a supply and no one in the village is given necessary training. Instead, the most loosely thought out self-help ideology is applied, in which the government assumes that if the people helped to build it and pay for it, then they will look after it. This type of thinking is found in many other countries as well. In fact, the government must formalize the maintenance task by giving constitutional powers to committees or individuals to conduct or direct the maintenance. They must also provide the necessary training for villagers and, in Lesotho, this means training women.

*Maintenance: social appropriateness at two levels*

So far, the term "social appropriateness" has been used mainly to mean appropriateness within the local community. The criteria examined have all been derived from the idea of helping the village (or it could be an urban community) to provide for itself more successfully. But the problems of maintenance in these piped water projects illustrate very clearly that the organization of such supplies needs to be thought out very carefully at two levels—village-level organization is obviously needed, but so too is appropriate organization at government or local government level.

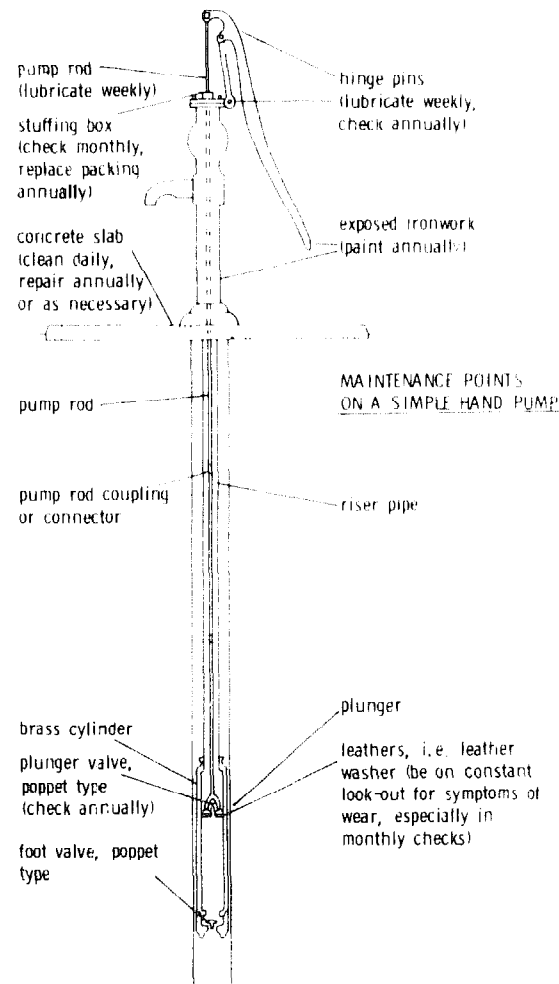
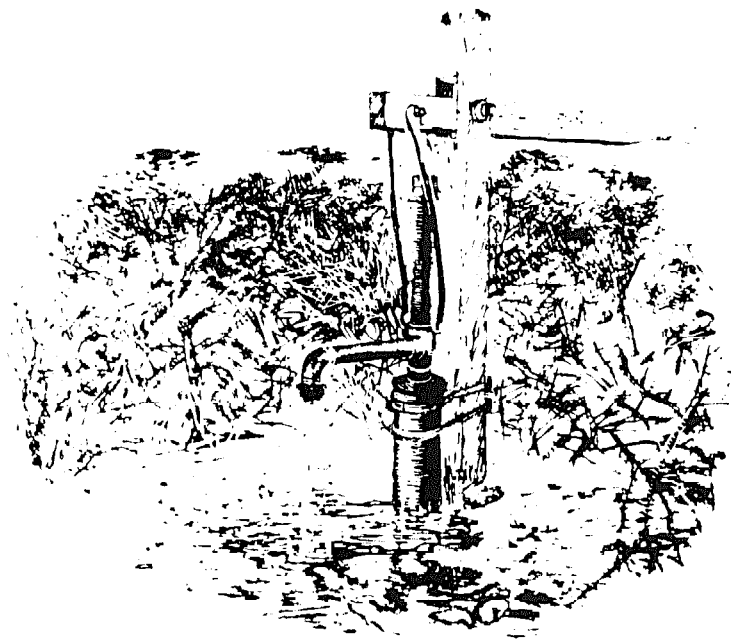

Fig. 20. Maintenance points on a simple hand-pump (after Pacey, 1976)

Both levels of organization are important during construction as well as with regard to maintenance. But the practical problems of construction are easier to solve; in a self-help project, the enthusiasm of the people is fairly readily sustained until construction is complete, or alternatively, where self-help is not involved, a well-run and well-equipped government unit can successfully design and install water supplies regardless of problems related to village organization. But maintenance cannot be dealt with that way. Village people must play a part, if only by preventing mis-use of equipment and keeping it clean—yet to expect complete self-reliance of them is usually more than is reasonable, except with unusually basic equipment such as the Ethiopian pump mentioned above. So maintenance involves people at government level *and* at village level; and it relies for long-term success on a clearly defined share-out of responsibilities between the two. The reason why the maintenance of village water supply equipment is so rarely satisfactory is that allocation of responsibilities is often vague, and the organization, training, equipment or materials needed to carry them out is often partly lacking.

Among the most notorious and difficult of maintenance problems is that presented by the many thousands of simple factory-made hand-pumps which have been installed at village wells and boreholes throughout the developing countries but in greatest numbers



*Fig. 21. Pump on a Karamoja borehole, Uganda. This type of pump is widely used in East Africa and adjacent areas, and has a comparatively good record for reliability in conditions where maintenance is somewhat rough and ready (illustration by Tag Ahmed).*

in the Indian sub-continent. The *New Internationalist* magazine (February 1975) has claimed that of 150,000 boreholes in India, 90,000 may be inoperable at any one time because of pump breakdowns. The figure can be disputed, but the dimensions of the problem are certainly very large indeed. In looking at the maintenance systems which are trying to cope with this problem, one finds many that are to some degree corrupt, and others where there is neglect of such basic management practices as keeping records of spare part stocks, and of the dates when each pump was serviced. Problems also arise because donor agencies specify pumps of different types, and no single stock of standardized parts can be used for maintenance. Among well-organized maintenance units in India, the usual policy is to expect villagers only to carry out the most routine maintenance tasks, and to arrange for a technician to visit the pump at regular intervals (e.g. every 2 months) in order to service it. In other countries, there is sometimes more stress on training the villagers, and technicians visit less often, or perhaps only when an emergency arises. In either case, the system depends on both villagers and on the central organization—the role of neither can be ignored—and it is absolutely essential that everybody knows definitely which maintenance tasks should be carried out by villagers and which by professional maintenance men.

To give an example of the detail with which responsibilities must be allocated and maintenance planned, it is worth considering the specific maintenance tasks which are needed with a simple hand-pump (Fig. 20). Some tasks need to be performed so frequently that the only practicable solution is for a villager to undertake them—these include the greasing of hinge-pins and sliding parts, and a regular daily cleaning of the well-head area. Other maintenance tasks suitable for a villager to undertake are those which do not require any special equipment (except spanners of the relevant size), for example, adjustments to the stuffing box, which may involve tightening the stuffing nut by a small amount.

In deep wells, changing the pump leathers involves lifting and unscrewing a very long length of pump rod, which is perhaps best left until a technician is present to help, but on shallow wells, a trained villager could do the job. Every detail needs to be thought out like this; the probable number of occasions when adjustments are necessary must be considered as well as the complexity of the job, and then a clear allocation of responsibilities between visiting technicians and a responsible villager can be worked out.

Enough has probably been said to indicate that social appropriateness is not only a crucial area, but a complex one. There are these vital but often neglected questions of *maintenance appropriateness* (to use the terminology of Table 2); there is the issue of *community appropriateness*, to do with whether the water supply is relevant to needs and problems which the local community is concerned about, and indeed, with whether the community's views have been sought; and there are problems of planning *work* appropriately, especially where a self-help approach is adopted. There are many other points to consider also (Table 2), many of them connected with the organization of projects and the allocation of responsibilities. All that has been possible here is a very brief sketch of some of the main social issues which arise in water supply work at village level.

#### **PART IV: ECONOMICALLY APPROPRIATE WATER SUPPLIES**

##### *Use of resources*

For a water supply (or any other technological development) to be economically appropriate, it must first and foremost make sparing use of scarce resources for which there are opportunities for alternative uses—but it may make liberal use of such resources as are plentiful in the locality concerned. For example, diesel fuel is a scarce and costly resource in many countries, and this means that a wind-driven pump which can do the same job as a diesel one is likely to be more economically appropriate.

Funds for capital investment are also a scarce resource in most developing countries, especially foreign exchange to pay for imported goods. Thus costly capital equipment, or expensive imported materials can only be appropriately used in small quantities, and only where there is no alternative. A drinking water well lined with local bricks and dug by local people who would otherwise be unemployed or under-employed need make no demands on foreign exchange, and would use scarcely any capital, and so would fully meet these criteria of economic appropriateness. But larger water supplies need tanks, pumps and piping which are all capital goods, and which in many countries have to be imported. Their use is essential, but wherever possible, ways should be found for replacing them wholly or partly by local materials.

The argument favouring intermediate technology, as it was originally presented (Schumacher, 1965), stressed the classical dichotomy of capital and labour resources. In most developing countries, it was stated, capital is scarce but labour plentiful, so labour inputs should be used wherever possible to replace capital inputs. Many water supplies depend upon earthworks such as dams, bunds, canals, excavated tanks, or simply trenches in which to lay pipes. The way to substitute labour for capital in such works is to arrange for the earth-moving to be done by people using picks and shovels, rather than by a bulldozer. This paper has already recorded several examples, ranging from the construction of large dams for water conservation in India, where up to 500 people might

be working on the site, to the digging of trenches for water pipes in Lesotho, which might be done by twenty villagers.

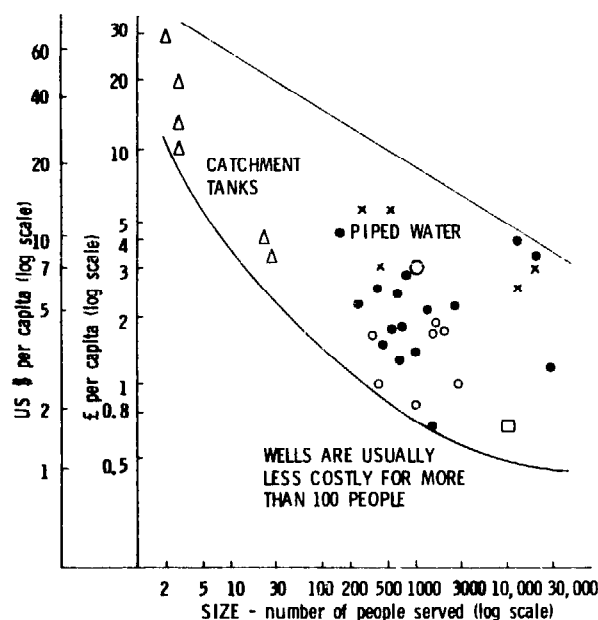

#### CATCHMENT TANKS

△ general cost level for Swaziland, Botswana and Rhodesia.

#### PIPED WATER

● gravity-flow schemes (large projects in Kenya and Malawi; small projects in Lesotho)

○ wind-pumps raising water from wells (Lesotho)

◻ hydraulic ram scheme (Swaziland, serving 1,000 people)

◻ electric pump (Kenya; serving 10,000 people)

× systems using diesel pumps (large schemes in Kenya; small schemes in Swaziland)

Fig. 22. Capital costs per person served for water supply schemes of varying size in East Africa and Southern Africa. All figures exclude the value of any self-help voluntary labour used, and all have been adjusted to 1971 prices.

The argument about substituting labour for capital is obscured in many countries because of the distortion of market prices. For example, minimum wage legislation tends to set wages at a high level that might be appropriate if there were already full employment. Similarly, the effect of government regulation of exchange rates is that foreign exchange is typically under-valued. In this situation, the market signals which engineers, farmers and others receive indicate that labour is expensive and capital cheap, when in fact the opposite conditions exist. Therefore, in these circumstances, it is difficult to achieve economical use of resources.

Since the stress in this paper has been mainly (but not exclusively) on self-help water projects, using voluntary labour, the argument for a labour-intensive approach is, if anything, strengthened. However, the size of tasks carried out on a voluntary basis needs to be matched to the size of the labour force, so that people do not become discouraged by enormous amounts of work being expected of them. The limiting extent of labour-intensity in this context is a human, not an economic one.

*Scale and service*

Arguments about the prudent use of resources are highlighted particularly strongly by parallel and apparently inconsistent arguments in favour of concentrating on small-scale development. Small water supplies, matched to the size of a village, may often seem more socially appropriate than large ones, and may therefore seem most suitable for construction on a self-help basis by voluntary labour. On the other hand, large-scale projects undoubtedly involve economies of scale and facilitate a more effective use of capital and materials.

Linked to the question of scale are problems connected with the distribution of water to scattered populations—the cost of a water supply may depend mainly on the number of hectares over which its consumers are spread rather than on the actual number of consumers. In a sparsely populated district, it may be necessary to provide very rudimentary small water supplies for isolated groups of people, in which case economies of scale cannot be attained, whereas in a densely populated area, a supply giving individual connections to a large number of people and a high level of water quality might still be very economical in terms of capital investment per person served.

In Kenya, the rural areas have been officially classified in terms of three ecological zones, depending on the agricultural potential of the area. Where the agricultural potential is highest, the greatest population density is found, and there is reasonable rainfall with good opportunities for developing water supplies. On the other hand, areas of low agricultural potential have dry climates with scattered populations and the development of water supplies is more difficult.

A study of future water supply possibilities in these three ecological zones indicated that in the low potential areas with scattered population, it would only be possible to develop water sources such as dams or wells—piped distribution could not be afforded. In areas of higher population density (50 people/km<sup>2</sup> or greater), the same funds (about £3.50 *per capita* when expressed in the same currency as used on Fig. 22) would be sufficient to pay for piped distribution with public standpipes.

Water supplies of a higher standard with full water treatment (including chlorination), and with piped connections to individual homes, were estimated to cost just over twice as much in these latter areas, but considerable economies were expected in regions which were very densely populated, and *per capita* costs for systems with individual connections were 25 per cent lower where the population density was 100 per cent greater.

In densely populated parts of Kenya and Malawi, large piped water systems serving up to 30,000 people have recently been built in rural areas. At the other extreme, in very sparsely populated areas, individual families may need to arrange their water supply independently of their neighbours, perhaps by using catchment tanks of various kinds; such an installation would constitute a supply system for half a dozen people. High *per capita* costs may obviously be expected from some types of very small systems.

Figure 22 shows how the *per capita* cost at 1971 prices varies with the size of a water supply project when "size" is measured by the number of people served. This measure ignores the different design criteria used in different schemes and the varied levels of service they provide. So when actual figures from Kenya, Malawi, Swaziland and Lesotho are plotted on the graph, a wide scatter of points is seen. All these points refer to schemes



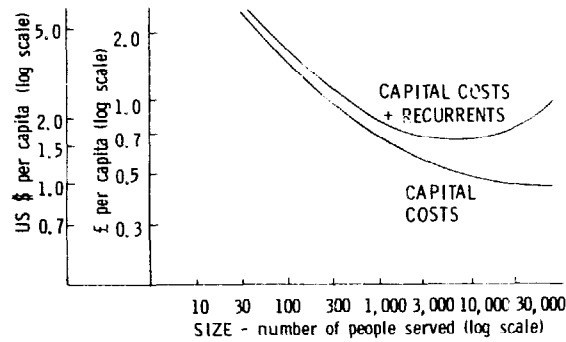

Fig. 23. Minimum costs of simple piped water projects, showing the effect of adding in the "present value" of future recurrent costs.

which provide a basic minimum service, however, with varying additional degrees of sophistication. The heavy curved line represents what appears to be the minimum attainable cost for this level of service—namely, for a service which brings a water point to within a reasonable distance (say, 100 metres) of most homes in the community, and which supplies at least 10 litres/person day and more usually around 30 litres. No water treatment is assumed, though some of these supplies include some kind of filtration and a period of water storage.

To estimate how many people might be served on this basis by catchment tanks, a mass flow calculation has been done for the region where a majority of those discussed here were built (Farrar, 1974), and the 10 litres/person day consumption figure has been assumed. All other supplies represented in Fig. 22 are piped systems, and an estimate of the actual number of people served is quoted.

Costs below the level represented by the main curve on this graph can sometimes be obtained by digging a well or protecting a spring, but without some piped distribution, such projects do not usually provide water as near to people's homes as the basic supply we are envisaging. Of the piped water schemes, gravity flow projects are sometimes relatively expensive because long pipelines are needed; where water is pumped by wind, hydraulic rams or electricity, the project is often as cheap as a gravity scheme. However, systems involving diesel pumps are nearly always more expensive.

#### *Recurrent costs and optimum size*

Consideration of capital costs alone suggests that the ideal *low-cost* scheme would be a very large one—small may be beautiful, but small is often expensive, and the need to spread the available capital as widely as possible would seem to demand that one look for economies of scale.

However, we have so far said nothing about recurrent costs: these may be very large for a big scheme, because while a small installation might be maintained and operated by users on a self-help basis, projects serving say, 20,000 people, demand a full-time staff, and entail other costs. The best way of deciding what type of project represents the best low-cost solution in these circumstances is to take the annual running costs for each year of the anticipated life of the installation, and calculate their "present value". This latter represents the capital sum which would have to be invested at the start of the project if all future running costs were to be paid from it. Using data (e.g. from Carruthers, 1973)

for some of the water supplies represented in Fig. 22, it is possible to estimate roughly how minimum costs for simple supply systems are modified when recurrent costs are added in (Fig. 23).

It becomes evident that instead of the scale factor always favouring larger schemes, there is an optimum size for a piped water project where the present value of all costs, capital and recurrent, is a minimum. This optimum size represents schemes which are small enough not to require full-time staff, and simple enough to be operated and maintained very largely by local people: it tends not to apply to schemes which use diesel or petrol pumps, whose running costs may be disproportionately high for small supplies.

One should remember that Fig. 22 and 23 indicate a general minimum cost for the four African countries from which data has been obtained. Within those countries, there will be many sites where difficult topographic or hydrological conditions mean that even the most simple and basic supply will cost considerably more than the minimum. In general, costs will be higher in semi-arid areas than in moister regions, and the optimum size of scheme may well be smaller. Additionally, inflation since 1971 will have greatly altered the costs given, though the shape of the graphs presented in Figs. 22 and 23 should be the same.

#### *Social objectives of low-cost schemes*

We have so far expressed the need for a low-cost approach solely in terms of the traditional intermediate technology argument about spreading available capital resources as widely as possible. However, for those who are also interested in a *socially appropriate* solution to the water supply problem in a self-help context, another objective will be to design schemes which are capable of being implemented and managed by the local people themselves.

From this point of view, the optimum size of scheme will depend on the size of groups with whom community development officers are working, and on the size of individual social units.

There is probably an upper limit to the size of project which can be managed successfully on a voluntary basis. With communities bigger than 2 - 3000 people, it is difficult to ensure that committees are adequately representative, or that voluntary officials can function effectively.

Finally in this list of limitations on self-help projects, it appears that voluntary labour contributes only a small amount to the construction of many very large projects—self-help labour is valued at less than 10 per cent of the total cost of large water schemes in Kenya. In smaller projects, the self-help contribution can be far more significant—around 30 or 40 per cent—and the social benefit of self-help proportionately greater. The value of self-help labour is not included in the costs shown in Fig. 22; if it had been, the higher *per capita* cost of small projects would be even more noticeable.

We conclude that where the encouragement of community self-help is one of the objectives of a project, considerations of social appropriateness dictate an upper limit to the desirable size of piped water supplies at around 3000 people. This compares with the most economically appropriate size indicated in Fig. 23 as around 3 - 10,000 consumers. Communities of around 3000 people would thus appear to have the best of both worlds,

though much obviously depends on local conditions, and a unit of 1000 people may be quite satisfactory in most circumstances.

### *Scale factors in irrigation*

Irrigation, even more than piped water, is a classic area for the operations of economies of scale. Construction costs are heavy, and therefore costs per hectare fall if these fixed costs are spread over a larger irrigated area. Similarly, professional operations and maintenance organization requires a minimum size of project to obtain an efficient operating system. The existence of large-scale irrigation systems was the common characteristic of almost all early civilizations in both the new and the old worlds. With relatively unsophisticated technology, large-scale projects worked well. Today's agricultural technology, particularly the new seed - fertilizer package, has greatly increased the potential of irrigated agriculture. Yet despite the scale economies and the technological opportunities, the general performance of large-scale projects is poor. Reports from irrigation schemes throughout the Indian subcontinent (e.g. Clay, 1973, referring to north-east India), speak of equipment being under-utilized, and the area of irrigated land being only a small fraction of the potential irrigable area which the project was planned to serve.

These failures may make small-scale irrigation schemes seem more attractive. But small-scale irrigation has higher fixed costs, because of the scale factor: and because such schemes are often located in remote areas, they are often not provided with efficient management services or technical and agronomic advice.

The key to this paradox is that large-scale schemes have a small-scale component in the form of individual plots and farmers' holdings, and what has often gone wrong is that efforts made to secure efficient working of the large-scale engineering have diverted attention from the small-scale, individual problems of farmers. Usually, irrigation activities are the province of engineers and the new water supplies are imposed on a traditional agriculture. Public responsibility ends at the canal outlet. The farmers have the very minimum of advice and assistance in relation to field channels, land levelling, drainage, agricultural practice and so on. These negative aspects of scale can themselves be negated to a large extent by a new perspective on large-scale systems from the individual small farm level. The gap between the potential and the realized agricultural productivity is so wide that an effective re-direction of effort would prove economically and probably financially productive.

### *Small-scale irrigation in pastoral regions*

In semi-arid areas whose scattered populations frequently depend heavily on keeping herds of animals, there is a better case for small-scale irrigation projects than elsewhere, and there are at least four functions which such projects may serve. The first is to create jobs in constructing and operating irrigation schemes in regions where job opportunities are generally very limited. The second function is to provide fodder resources to help alleviate regular (and occasionally severe) drought fodder crises. The third function is to provide food of a different nature to the main livestock products. Irrigation projects can produce protective foods such as vegetables, an important component of any balanced diet. The fourth function of irrigation schemes is to act as a nucleus for service centres from the various communities living in a nomadic or semi-nomadic existence. If an irrigation scheme provides permanent jobs, water supply, fresh fruit and vegetables, and this is at a place where it makes sense to locate a regional service centre, the small-scale

irrigation project should not be judged simply on the basis of its financial performance and its economic appropriateness, but on its usefulness to the general development of the area.

*Complementary criteria of appropriateness*

Rainwater catchment tanks are essentially a technique for very small-scale water supply, and appear on Fig.22 as relatively high cost supplies, because of the way economies of scale tell against them. The effect of scale is again demonstrated when comparing large catchment tanks with small ones. A very large roof tank of 70,000 litres capacity was estimated to cost £1.50 per thousand litres storage in 1971 (a "beehive" tank of the same capacity cost 20% less). In contrast, comparable roof tanks of 9000 litres capacity constructed by the cheapest possible methods cost £3.90 per thousand litres storage, and smaller tanks of 2000 litres capacity, £7.10.

Criteria of economic appropriateness obviously do not favour catchment tanks, especially very small ones. However, we have seen that such tanks have other, very definite advantages. They may be socially appropriate as individual water supplies (though not for school or community supply projects), and they are environmentally very appropriate in regions where water resources are generally limited, and the collection of rainwater during storms is an important source of supply. In these instances, shortages of resources may enforce a high cost for all water supplies, and make catchment tanks economically competitive.

Where individual supplies are concerned, the advantages of having clean water stored conveniently near to the house under the householders's own control may outweigh the high cost, at least for those families who are sufficiently prosperous to be able to afford it. One can express the compromise being made between economic appropriateness and other advantages by saying that these advantages are "worth the extra cost".

The same will sometimes be true in considering piped water supplies. If a piped supply can be made socially appropriate to the extent that the people who use the water take pains to look after the equipment, and maintain it, and use the water to the benefit of health or of their farming activities, then the higher *per capita* cost of a small-scale supply may be fully justified. As explained in the introduction to this paper, the objectives of most water supply projects go a good deal further than just to have water flowing out of a pipe. Cost levels based on volumes of water stored or supplied are thus not sufficient criteria, because in order to meet other objectives relating to health, or to environmental and social appropriateness, additional costs will nearly always be involved.

Reviewing the way in which the different criteria of appropriateness apply to the catchment tanks, one may say that where health and sanitary matters are concerned, with suitable precautions against bird droppings on roofs they offer good quality water which is unlikely to transmit water-borne diseases. The tanks are environmentally appropriate in dry regions, and also in any other conditions where catchment of storm water can add usefully to limited water resources. With regard to social appropriateness, the tanks are best suited for use as individual household supplies, and will only rarely be satisfactory for a community supply. Some tanks require a lot of labour for construction, which may be a disadvantage in a self-help project. Finally, with regard to economic appropriateness, the most noticeable point is the high unit cost already commented on. The tanks will be

an appropriate technology in circumstances where the balance between these different criteria of appropriateness is a favourable one—where the advantages of good health, environmental and social appropriateness out-weigh the high cost.

An alternative way of balancing these different criteria of appropriateness against one another is to carry out a cost/benefit analysis. In principle, this allows the whole issue to be translated back into economists' language from the vocabulary of appropriateness used in this paper. But to carry out this translation would not always be an advantage, because the benefits conferred by different kinds of appropriateness are not always quantifiable. By talking about the "health cost" and the "time energy cost", of water, White *et al.* (1972) introduced ways in which some of the benefits of improved water supply can be balanced against the cost of making the improvement, but even their approach is not comprehensive enough to cover all the benefits implied by the different criteria of appropriateness we have discussed.

However, rational choices between technological alternatives do sometimes depend in an important way on the question of how costs and benefits occurring at different points in time should be compared, i.e. how they should be discounted. When discount or interest rates are assumed to be high, the balance is tipped more in favour of techniques which save on the initial capital investment, e.g. by use of labour-intensive methods or by installing a pump to cut out a long length of costly pipeline. When discount rates are low, systems with a higher capital cost but low running costs are favoured and this is of great importance when selecting technologies for large concentrated capital investments (such as urban excreta disposal systems). However, for small-scale water supplies it may be less relevant because the basic technology choice is largely dictated by the other criteria of appropriateness discussed previously.

## **PART V: CONCLUSION—WATER FOR THE THOUSAND MILLIONS**

### *Obstacles to progress in water supply improvement*

There are just over 1000 million people in the world's rural areas who do not have reasonable access to a safe water supply. Of those who have access to an improved supply, many cannot be assured of its reliable and continued operation, because maintenance of the equipment is a serious and unresolved problem in many countries. Some of the maintenance problems experienced with hand-pumps, wind-pumps, water treatment plant, catchment tanks and piped supplies have been mentioned. In extreme cases, these problems have been so serious that a water supply improvement has survived intact for only a few months or even weeks after construction.

The criteria of appropriateness which have been discussed in this paper are mainly criteria relevant to the design or evaluation of an individual village (or small urban community) water supply. They give a village-level perspective on what constitutes an appropriate water supply, and this has enabled us to point out various ways in which an inappropriate approach may lead to waste of resources or the failure of equipment.

For example, where techniques or equipment are not environmentally appropriate, their working efficiency is greatly reduced, and they may have a very short life. Open reservoirs in semi-arid tropical countries and conventional sewage treatment plants in

warm climates are examples of this. The widespread problem of poor maintenance, though, is not so much due to technical problems such as these, but arises most often when water supplies are not socially appropriate. This may mean that villagers do not feel responsible for the equipment and so do not take care of it and prevent its misuse, or it may mean that the equipment is too complex for the local maintenance organization to cope with, or simply that no such organization exists.

Waste of resources occurs wherever water supplies do not function properly for any of these reasons; waste also occurs when supplies are not economically appropriate and absorb more capital, or more imported materials than necessary; and finally, there is waste wherever failure to understand the relationship between water and health leads to the pursuit of unrealistic criteria of health and sanitary appropriateness.

If individual community water supplies could be made more appropriate in all these different ways, financial and manpower resources might be utilized more efficiently, so that there would be some hope that more communities might benefit more quickly from water supply improvements. If reliability and maintenance problems could be overcome by more appropriate organization and choice of equipment, there would be less danger that water supply improvements would be constantly negated by equipment failures—and hence, less danger that the gains achieved in tackling the world water problem will be lost by a constant slipping back to the use of original water sources as “improved” systems fail.

#### *The policy-maker's viewpoint*

In order to assess how relevant these points about village-level appropriateness are to the global problem of 1000 million people without adequate water supplies, it is necessary to move from the village-level perspective of much of this paper to the policy-maker's perspective—to turn from problems of organizing village water committees to the problems of government departments which plan and build water supplies.

It may be obvious that water supplies which are more appropriate will be easier to maintain and keep in order, but how does this relate to the capabilities of maintenance staff scattered throughout the country and employed by departments of local government? It may be obvious too that more appropriate water supplies will use fewer resources and cut out unnecessary or wasteful investments, but how important is this when set against the size of the investment funds available? Would it really be true, for example, that if more projects were economically appropriate, and labour-intensive construction was more widely used, then the capital sums saved could be diverted into extra supply improvements which currently cannot be afforded? The fact seems to be that even though the capital sums currently being spent on water supply are less than is necessary to make an impact on the total problem, shortage of funds by itself is not a major obstacle to progress. There is money currently available for water projects which cannot be spent because of other blockages in the planning and construction of supplies. Of course, there are some countries which have been badly hit by the world economic recession, and which have curtailed water supply programmes because of shortage of funds, but there are others which find that they need to increase their “absorptive capacity ... to have maximum benefits from capital aid” (Lesotho/IDRC, 1976).

It is also the experience of donor agencies which have funds to spend on water projects that there is often difficulty in finding promising schemes which need finance. Two

agencies come to mind, one British and one Scandinavian, and both would like to spend more on water supply improvement in Africa, but cannot find good projects in need of the money. One of these agencies would like to double its expenditure on water supplies in Tanzania, but finds that the additional funds could not be used.

So whereas funds are, in principle, inadequate, and whereas some water supplies may absorb too many funds because they are not economically appropriate, there must also be some more critical limitation on the rate at which water supply improvements are carried out.

Some clues as to where the problem might lie were provided by a meeting of water supply officers from four African countries which recently drew up a list of problems confronting them in the development of rural water supplies (Lesotho/IDRC, 1976). Out of eleven topics raised, nine were strictly technical in nature, or were connected with the dissemination of technical information. Of the other two, one was related to the economic appropriateness of supplies, and the other was a matter of manpower planning and the training of water supply technicians.

The preponderance of technical problems in this list would seem to imply that it is a lack of suitable technology which is holding up the development of supplies in these countries. There is certainly much room for technological innovation and many useful new discoveries will be made: until they are discovered we cannot say what they will be! But the more predictable area of technological advance for water supplies is in relation to specific sites. A recent discussion in London on intermediate technology research and development for rural water supply in general did not find a major programme to support—though they did think that there was urgent need for serious development programmes on effective alternatives to water-borne sewerage systems, and they mentioned water conservation as another possible area for research.

The conclusions of these two meetings, in Africa and in London, are not so contradictory as might seem. The London meeting reviewed the world situation, in which it is probably true that there is no major principle or technique lying unused for want of research and development. On the other hand, the African meeting pinpointed specific local problems, such as high levels of iron in groundwater in Malawi, and problems with slow sand filters in Zambia (Lesotho/IDRC, 1976). As already pointed out, there is always need for research into local problems, into ways of adapting existing technology to local needs, or into the better use of local materials. It is very important that universities and research institutes take up such questions in their own regions and undertake serious work on them. Dissemination of technical information is probably a serious problem also, with busy water officials unaware of new techniques which could aid them, and local universities might possibly help with this also.

Where, perhaps, a serious difficulty does lie is in the very diversity of techniques and equipment available. Choice is difficult and confusing, and the standardization of equipment necessary for easy maintenance and replacement of parts is often not achieved. Progress in the provision of rural water supplies could often be speeded up quite significantly if a limited range of standard equipment were adopted for use throughout a particular country or region, with compatible parts that fitted together easily. The precise range of equipment would depend on the water supply opportunities in the region concerned, but a well-digging kit including moulds for making concrete well linings, a spring

protection kit, and a series of piped water kits for villages of 200 - 300 people would be among the items most widely required. If this policy were adopted, the purchasing and supply of equipment would be greatly simplified, and the replacement of broken or damaged parts would be easier.

So although we do not believe that lack of appropriate technology is, in principle, the fundamental problems, there are a number of ways in which research and development could be useful, and these can be summarized as follows:

- (1) adapting techniques to cope with special local problems, or to make use of local materials (see Part II(b) above);
- (2) Standardizing equipment and developing "kits" of tools and components for specific kinds of water supply;
- (3) Improving sanitation systems which offer various kinds of alternative to conventional water-borne sewerage (Part II(a) above), and
- (4) Water conservation, groundwater recharge and rainwater harvesting, especially to include special techniques for local conditions (Part II(c) above).

#### *Manpower problems*

A far more significant problem than lack of appropriate technology is lack of organizations, institutions and people to put appropriate technology into practice. Shortage of skilled manpower is a widespread problem, especially in Africa, and it is significant that although the African water supply officials previously mentioned were greatly concerned about a range of technical problems which seemed to be restricting progress, they were most unanimous and emphatic in pointing out manpower planning and the training of technical staff as a critical problem in the more rapid provision of village water supplies.

In Lesotho, the need was defined in terms of four categories of manpower: administrators or planners; high level technicians to deal with wind-pumps, boreholes and diesel pumps; medium level technicians to deal with pipe laying, spring protection and tank construction; and people in the villages trained to maintain their own community's supply. Malawi stated a need for "the employment and training of a new kind of personnel to maintain the shallow wells" (Lesotho/IDRC, 1976).

Shortage of skilled manpower is probably most urgent at the level of technicians and surveyors capable of marking out the route for a pipeline, setting up tanks and joining up pipes, and most important of all, capable of maintaining the equipment already in use. This being so, the urgency of the water supply situation in many countries would seem to demand the rapid training of large numbers of people in a few basic skills, to produce what may be described as "barefoot water technicians". Such technicians would be people who already have a little basic technical training as fitters, surveyors or public health officers, and who would be given a 3 or 4 week crash course in the design and construction of some type of water supply (Pacey, 1976). Very brief training courses would be feasible because the technicians would specialize only in one type of supply. Some would be able to design and build simple piped water supplies, some would specialize in wells and some in catchment tanks. The type of training given would have to be planned according to the needs and opportunities in the region concerned.

This system would work particularly well if, as already suggested, a system of standardized parts were developed for the technicians to use in the supplies they designed. To



go with these kits of parts, ready reckoners or nomographs could be devised so that the optimum pipe diameter or tank capacity could be selected from a limited range in the "kit". This method of replacing virtually all calculations by nomographs or tables has been used in one or two countries faced with rapidly training large numbers of soil conservation officers, and the design of small earth dams was included within their work. There is no reason why a similar approach should not be practicable with other aspects of water supply.

Several countries already use technicians to design village water supplies, at least on a small scale. In one small African country, about 30 village piped water supplies are built every year by technicians helped by people from the villages who give their labour on a self-help basis. In another African country, public health officials were given a two-week course on water supply construction and then designed and supervised the building of small supplies using standard components. In a very small project elsewhere, three technicians trained to build ferrocement tanks for rainwater catchment from roofs successfully completed 200 tanks in about 18 months.

It is probably significant that in the particular countries where these experiments are being tried in an effort to speed up the installation of village water supplies, it is often the community development or health departments of government which are doing the work, and not the official water supply departments. We have already observed that the professional engineers within water departments appear to be inhibited in their approach to village water supplies by an out-dated sense of what is technically appropriate—in fact, by professional codes of practice, by WHO water quality standards, and by their feeling that a "proper engineering job" is often impossible in rural water supply. Thus the pioneering work in the rural areas has often been left to community workers and health officials, who have not been trained as engineers, and who therefore lack these inhibitions.

The term "barefoot water technician" is apt, not because of any close parallel with Chinese practice, but solely on the grounds that if adequate steps to tackle the world's rural water problem are eventually taken, they will present as much of a challenge to professional attitudes in engineering as the "barefoot doctor" concept did to professional medicine. The effective use of these rapidly trained technicians would demand a different approach to codes of practice and to the whole organization of water supply provision in most developing countries.

The introduction to this paper argued that not only must technology be appropriate, but it must be complemented by appropriate organization if it is to be effective. There has not been space in discussing the technological aspect of water supplies to explore in detail the kinds of organization and the institutional changes which may be needed, but possibly the concept of the barefoot technician gives a clue to the kind of appropriate organization required. The problem is certainly not *just* a manpower issue—India is probably already endowed with sufficient skilled manpower—it is also a question of the organization and deployment of manpower.

### *Conclusion*

We have set out to look at the role of intermediate technologies in water use and we found, as this paper reflects, that technology only has a role in its environment and in its socio-economic context. The most appropriate technology is often missed because the

range of options offered to most communities and considered by governments is too restricted. There are technological approaches with high or low capital costs, variable labour inputs and maintenance needs. Water supplies are not an all-or-nothing phenomenon. Almost every situation lends itself to some improvement, even if funds and skills are severely limited. By going back to the objectives of water improvement and sometimes disregarding rules-of-thumb formulated elsewhere, and by choosing among the vast range of technological devices those which are most appropriate to the particular situation, water supplies for the thousand million *can* be improved. That is the hope of technology.

### REFERENCES

- Bradley, D. J., Predicting the epidemiological effects of changing water sources, part II, *E.Afr.Med.J.* **45**, 333 (1968).
- Bradley, D.J., Water Supplies: the consequences of change, in *Human Rights in Health*, Ciba Foundation Symposium 23, ASP, Amsterdam, 1974.
- Burns, R. H. and Howard, J., *Safe Drinking Water: an Oxfam Technical Guide*, Oxford, U.K., 1974.
- Carruthers, I. D., *Impact and Economics of Community Water Supply*, Wye College, Ashford, Kent, U.K., Agrarian Development Unit report no. 6 (1973).
- Clay, E.J., Tubewell irrigation technology in NE India. Appropriate Technology conference reports, University of Edinburgh, (1973).
- Farrar, D.M., *Aspects of water supply and conservation in some semi-arid parts of Africa*, unpublished Ph.D. thesis, University of Manchester Institute of Science and Technology, Manchester, U.K., (1974).
- Feachem, R. G., Water Supplies for Low Income Communities in Developing Countries. *Environmental Engineering Division, ASCE*, **101: EE5: 687 - 702** (1975).
- Feachem, R. G., Appropriate Sanitation, *New Scient.* London, 8 January (1976).
- Feachem, R. G., Water Supplies for Low Income Communities: resource allocation, planning and design for a crisis situation, in *Water Wastes and Health in Hot Climates*, by R. G. Feachem, M. McGarry and D. Mara. John Wiley, London, 1977.
- Hindson, J. R. E., *Protection of Dambos by means of Contour Seepage Furrows*, Lusaka, Zambia, Department of Agriculture, 1962.
- ITDG, *The introduction of rainwater catchment tanks and micro-irrigation to Botswana*, Intermediate Technology Development Group, London, 1969.
- Lesotho/IDRC, *Rural Water Supply and Sanitation: research priorities in Lesotho, Malawi, Swaziland and Zambia*, report of a meeting sponsored by the Kingdom of Lesotho and the International Development Research Centre, Ed. Richard Feachem, IDRC, Ottawa, Canada (1976).
- Maddocks, F. *Report on Low-cost Waterproof Membranes*, (for rainwater catchments), Intermediate Technology Development Group, London, (1975).
- Mann, H. T. and Williamson, D., *Water Treatment and Sanitation: simple methods for rural areas*, Intermediate Technology Development Group, London, (1973).
- Oxfam, *Information from Oxfam: rural water supply projects*, KN 2, LES 16 and IS 79, 1975 and earlier dates, Oxford, U.K.
- Pacey, A. *Hand-pump maintenance*, Oxfam Social Technology Manual No 1, 1976.
- Schumacher, E. F., Social and economic problems calling for the development of intermediate technology, UNESCO conference on the application of science and technology to the development of Latin America (1965); reprinted in *Small is Beautiful*, by E. F. Schumacher, Blond and Briggs, London, 1973.
- White, G. J., Bradley, D. J. and White, A. U., *Drawers of Water: domestic water use in East Africa*, Chicago University Press, 1972.