



This is a digital copy of a book that was preserved for generations on library shelves before it was carefully scanned by Google as part of a project to make the world's books discoverable online.

It has survived long enough for the copyright to expire and the book to enter the public domain. A public domain book is one that was never subject to copyright or whose legal copyright term has expired. Whether a book is in the public domain may vary country to country. Public domain books are our gateways to the past, representing a wealth of history, culture and knowledge that's often difficult to discover.

Marks, notations and other marginalia present in the original volume will appear in this file - a reminder of this book's long journey from the publisher to a library and finally to you.

### **Usage guidelines**

Google is proud to partner with libraries to digitize public domain materials and make them widely accessible. Public domain books belong to the public and we are merely their custodians. Nevertheless, this work is expensive, so in order to keep providing this resource, we have taken steps to prevent abuse by commercial parties, including placing technical restrictions on automated querying.

We also ask that you:

- + *Make non-commercial use of the files* We designed Google Book Search for use by individuals, and we request that you use these files for personal, non-commercial purposes.
- + *Refrain from automated querying* Do not send automated queries of any sort to Google's system: If you are conducting research on machine translation, optical character recognition or other areas where access to a large amount of text is helpful, please contact us. We encourage the use of public domain materials for these purposes and may be able to help.
- + *Maintain attribution* The Google "watermark" you see on each file is essential for informing people about this project and helping them find additional materials through Google Book Search. Please do not remove it.
- + *Keep it legal* Whatever your use, remember that you are responsible for ensuring that what you are doing is legal. Do not assume that just because we believe a book is in the public domain for users in the United States, that the work is also in the public domain for users in other countries. Whether a book is still in copyright varies from country to country, and we can't offer guidance on whether any specific use of any specific book is allowed. Please do not assume that a book's appearance in Google Book Search means it can be used in any manner anywhere in the world. Copyright infringement liability can be quite severe.

### **About Google Book Search**

Google's mission is to organize the world's information and to make it universally accessible and useful. Google Book Search helps readers discover the world's books while helping authors and publishers reach new audiences. You can search through the full text of this book on the web at <http://books.google.com/>



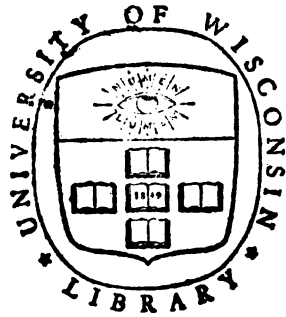















**PRACTICAL THINGS WITH  
SIMPLE TOOLS**

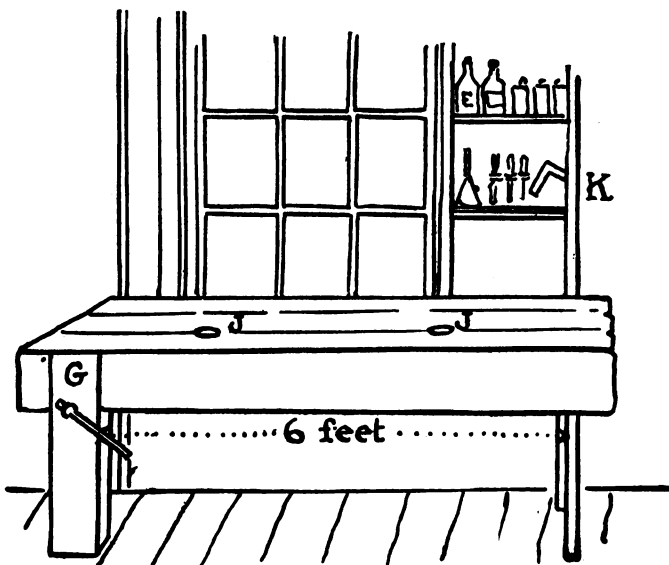
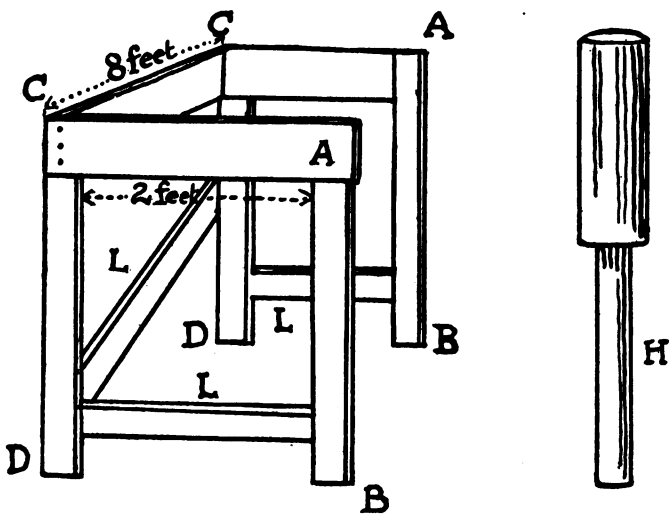

A CARPENTER'S BENCH  
(See Page 5)

# Practical Things With Simple Tools

*A Book for Young Mechanics*

By  
Milton Goldsmith



New York  
Sully and Kleinteich  
1916

**COPYRIGHT, 1916, BY**  
**SULLY AND KLEINTEICH**

*All rights reserved*

272482

JAN -2 1924

IKTG

G57

## CONTENTS

Introduction . . . . .	1
General Directions . . . . .	3
A Carpenter's Bench . . . . .	5
A Boy's Tool Chest . . . . .	8
A Pushmobile . . . . .	11
Sidewalk Coasters . . . . .	15
A Coaster Wagon . . . . .	19
Kites . . . . .	23
Tailless Kites . . . . .	26
Box Kites . . . . .	29
Kite Reels . . . . .	32
Stilts . . . . .	35
Tops . . . . .	38
Bow and Arrow . . . . .	41
A Sucker and the Process of Suction . . . . .	43
Spring Guns . . . . .	45
Tip-Cats . . . . .	48
A Pretty Doll's House . . . . .	51
Dolly's House-Furnishings . . . . .	57
Cigar-Box Toys . . . . .	58

Wagons and Wheelbarrows . . . . .	63
A Trolley Road . . . . .	66
A Primitive Flying Machine . . . . .	71
A Toy Motor Boat . . . . .	74
A Pantograph . . . . .	78
A Camera Obscura . . . . .	81
A Simple Drawing Apparatus . . . . .	85
A Pencil Sharpener . . . . .	88
Toboggans . . . . .	91
A Rockaby Coaster . . . . .	94
A Bobsled . . . . .	97
A Swift Ice Boat . . . . .	101
A Land Boat . . . . .	104
A Cage for Mice . . . . .	108
Traps for Animals . . . . .	111
A Pigeon House . . . . .	114
Pretty Dovecotes . . . . .	116
A Sensible Dog Kennel . . . . .	120
Protection for Birds . . . . .	123
Houses for Guinea Pigs and Rabbits . . . . .	126
Chicken Coops . . . . .	129
A Practical Water Wheel . . . . .	132
An Undershot Wheel . . . . .	136
An Effective Power Wheel . . . . .	139
A Practical Windmill . . . . .	142

CONTENTS

vii

Picture Frames . . . . .	145
An Ingenious Camp Stool . . . . .	148
A Useful Box . . . . .	151
Furniture and Fixtures . . . . .	152
Bookshelf and Closet . . . . .	155
A Handy Shelf and Closet . . . . .	158
A Rustic Garden Seat . . . . .	161
A Clotheshorse for the Kitchen . . . . .	163
A Useful Box for Shoe Blacking . . . . .	165
A Home-made Stepladder . . . . .	168
An Umbrella Stand . . . . .	171
An Ornamental Coal-Box . . . . .	174
A Rustic Window Seat . . . . .	177
A Cigar-Box Cabinet . . . . .	179
A Summerhouse . . . . .	182
Gymnastic Horizontal Bars . . . . .	186
Parallel Bars . . . . .	189
Swing and Trapeze . . . . .	192
Wigwams . . . . .	195
Novelty Paper Boxes . . . . .	198
Slings . . . . .	202
Thaumatropes . . . . .	205
A Homemade Talking Machine . . . . .	207
A Vibratory Telephone . . . . .	211





# Practical Things With Simple Tools

## INTRODUCTION

**NEARLY** every boy feels the desire, at some time or other, to make useful and pretty things for himself, or his playmates, and just as often is quite sure that he can handle tools as successfully as any carpenter or joiner whom he has ever seen at work. While, as our boy will soon discover for himself, the use of tools must be learned, like everything else that is worth while, he can, by the exercise of a little skill and care, soon become sufficiently proficient to do neat and strong work. It is for the instruction of the aspiring young mechanic that the following pages have been written. The instructions which they contain will furnish constant amusement, also real education, to any boy who will follow them faithfully.

It has been the aim of the author to select only such articles as can be made with the simplest of tools and with little or no preparatory knowledge of carpentering. The saw, hammer, chisel, square, knife, plane,

screw-driver, and auger are all the implements that are needed. Many of the articles can be made of boxes, boards and remnants of wood, such as may be found in almost any locality, and in only a few instances need the blacksmith's help be asked.

Every step in the making has been described in the simplest terms, and the measurements are as explicit and as near to scale as possible. In many cases the dimensions must depend on the boxes and materials that the amateur mechanic has on hand.

Every article described can be made without difficulty. The instructions are not experiments, but have been tried out and are thoroughly practical. Difficult devices or machines that require skill or the outlay of considerable money have been carefully omitted. The book will aid boys to develop their mechanical bent and ingenuity while amusing themselves. Their work becomes play and their playing develops into useful work.

## GENERAL DIRECTIONS

FOR the best results in making the articles from wood, the novice should remember the following directions:

All wood should be dried and thoroughly seasoned. Old boards are better than new ones and can be procured from any lumberyard. If you have a good plane, it is well to use it on the rough surface of your board. Sandpaper the board thoroughly. If you do not intend to paint the article, rub it well with a flannel rag wet in linseed oil. This will bring out its natural grain and preserve the wood. Glue should be used for all joints, and they should be kept under pressure until the glue dries. Then wire brads should be used to hold the joints and give them greater strength. For small articles the cedar wood of which cigar boxes are made, is excellent. Many a useful and ornamental article can be made from a discarded cigar box.

Have your tools sharp and in good condition, and keep them where you can lay your hands on them in the dark if necessary. Neatness and care in putting

away tools, or articles that may be needed, are of prime importance. Never leave any edged tools with the sharp end up or the edge unprotected, for while rummaging for a nail or other articles you may cut yourself. Always put away your dangerous tools so that a child would run no risk if it were to ransack your room.

Keep all your nails, screws, etc., assorted and each size by itself in a little receptacle. Never throw away any old piece of metal, spring, nut, etc., as they may all come in handy some time or other. The old story of the banker who laid the beginning of his wealth to the fact that his employer saw him pick up a pin, points a useful lesson. The writer of this once picked up an old screw and two days afterward saved several dollars in the repair of a piece of machinery by the use of it.

Measure everything accurately; don't trust to luck. The sixteenth of an inch is a very small quantity, yet a box or a drawer that is a sixteenth of an inch out of plumb will be a failure.

## A CARPENTER'S BENCH

After the young carpenter has obtained the few necessary tools for his work, the most important thing for him to consider is the making of a good work bench. Even with the best tools, one can do very poor work on a kitchen table, or, in fact, upon any support that is not perfectly steady and sufficiently large to give one plenty of room for both work and tools. An unused room, such as a wood shed or the attic of your home, is the most suitable place for the workshop. A carpenter soon causes chips and sawdust to fly, and the floor and walls of the workshop are quickly choked and covered with them. No well-kept living room is suitable for the purpose.

When you have chosen your workroom, and obtained permission to use it for carpentering, you may set up your bench. Place it before a window, so that you will have plenty of light to show you what you are doing. The legs are made of four pieces of two-by-four-inch

lumber, two feet eight inches high, *A B* and *C B*. Attach them to the floor, the two back ones against the wall six feet apart and the two front ones in parallel lines two feet from the wall. If the walls of the room are not plastered, the two back legs can be saved by using the uprights of the wall as the back legs. In that case nail a heavy board, *C C*, six feet long and four inches wide, against the wall, the upper edge at a height of two feet eight inches from the floor. For the front, *A A*, use a board, one inch thick, six inches wide, and long enough to extend about three inches beyond the legs. Nail this securely to the legs, *A B* (see Frontispiece).

For the sides, *C A*, cut two boards, two feet eight inches long and six inches wide, and nail them to the legs even with the top. Your frame and legs being completed, you must make your top of one-and-one-quarter-inch planks, sufficiently wide to cover the framework completely and be plumb with the top front support. Nail these securely to the side and front supports, and be careful to drive in the nailheads with a die of steel, so that they will not stick out and injure your tools.

An iron or wooden vise can be obtained from a hardware shop and attached to the front of the table at *G*. Bore a number of holes, *J*, in the top of the

table, into which you can insert wooden pegs, *H*, when necessary, to hold boards that you desire to plane. A little experience will tell you just where the holes should be made.

On the wall over the bench there should be shelves, *K*, to hold odd tools, an oil can and the varnishes, stains, etc., needed in your work. The shelves can be made of suitable boxes or of homemade shelving to fit out odd corners.

A sliding drawer in the front of the bench will be found very useful. The front planks, *A A*, should then be eight inches wide. A shallow box will do nicely for the drawer.

An opening just the size of the side of the box or drawer must be cut into the plank, and a board a little wider than the drawer and long enough to reach from the front to the back of the bench should be nailed on a level with the lower edge of this opening. Upon this the drawer rests when closed. A knob by which to pull out the drawer can easily be obtained. It is not necessary to stain the bench, but it may be left the natural color of the wood. Crosspieces and braces, *L*, between the uprights will help steady the bench and make it more secure.



## A BOY'S TOOL-CHEST

ONE of the first requirements for a boy who desires to become proficient in the art of making toys is a well-equipped tool-chest in which to keep his instruments, for those that have to be bought are expensive. It

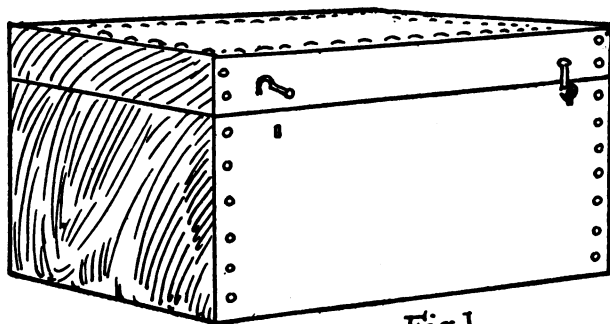

Fig 1

should be a matter of pride with the boy to make his own box. No matter how plain it may be, it will be of his own designing, and therefore all the more valuable to him.

The foundation may be any kind of a wooden box

sufficiently large to hold the tools. A grocery box two feet square at the base and eighteen inches high with a lid to match will answer. A box such as is used by shoe manufacturers is even better, as the wood is thinner and better joined.

Hinge the lid with a pair of brass hinges, and get two brass hooks and hasps to secure it when closed. Next make a tray, *A*, Fig. 2, that will fit into the box snugly. This should be about four inches deep, and

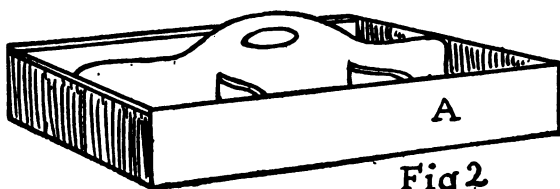

Fig 2

have a number of compartments made by means of thin wood uprights glued into place or held with thin wire nails. These sections will serve admirably to hold nails, screws, etc., all of which should be kept nicely assorted.

The lid should be provided with leather loops, *B*, Fig 3, to hold screw-drivers, gimlets, and other small utensils. The body of the box is for the larger tools, braces, hammers, saws, etc.

Finally, the appearance of the chest can be greatly improved by studding the edges with brass-headed tacks, as in Fig. 1.

To be well equipped is the first step towards doing perfect work, and a tool-chest such as just described will make work easy by providing the right tool when wanted. A good motto in this connection is, "A place for everything, and everything in its place."

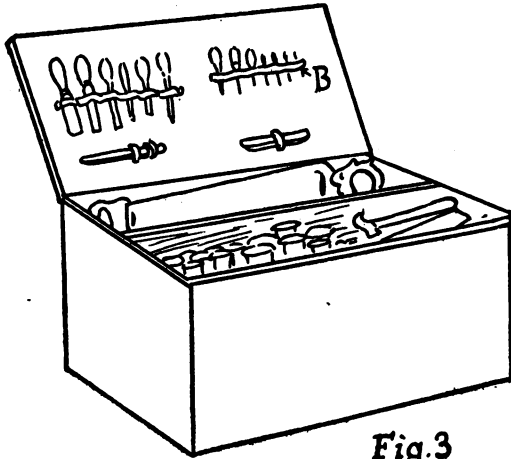

*Fig. 3*

## A PUSH-MOBILE

IN this age of automobiles, when even people of limited means can afford one, it is a reflection upon a boy's skill and ingenuity not to possess at least a home-made auto, especially when the cost is only a few cents and a few hours of labor. Push-mobiles are therefore very fashionable, and add a great deal to a boy's happiness. In fact, two boys can share the same vehicle and happiness at one time.

For the body, *A*, get a board about six feet long and eighteen inches wide. It should be at least one inch thick, so as to stand the strain. If a single board of these dimensions can not be had, then you can make the body out of two long boards of half the width, joined and held together by wood or iron battens. Four wheels from some baby carriage are the next requisites. If such wheels are not to be had, you will have to saw them out of wood, of the right diameter. The front wheels, *C*, are smaller than the rear, *B*. The rear

wheels are attached to the body about a foot from the back end. They are securely fixed by means of a couple of bolts going through the body and the axle. The front wheels are attached by their axle to a block of wood, which is in turn fixed to the center of the board, *A*, a foot back of the front end by a single bolt, which goes through the body, *A*, the block, and the axle in such a way that the axle turns to the right and left for steering purposes. A turnplate of an old wagon could be placed between the axle and the block to make it turn easier, and this should be frequently greased.

The steering gear is made as follows: Take a piece of curtain rod about two and a half feet long, *D*. Cut out a block of wood three inches square and nail it to the body board in the right position, *E*. Bore a hole through this block and the body and insert the lower end of the curtain pole. An iron rim or collar should be screwed to the rod just above the block to prevent it from coming down too far, and a similar collar at the point just below the body to prevent it from slipping up. The rod should project about four inches beneath the body. A small wheel, *F*, is used for the steering. This may be an old wagon wheel, or one cut to order. The top of the rod must be whittled down to fit into

the hub of the wheel, and made fast by means of wedges or screws. A wire or strong rope is used to connect the front wheels with the steering rod. The ends are tied to one of the axletrees near the wheels. Several turns of the wire or string are taken about the lower end of the rod, and passed through a small hole to prevent slipping. Then several more turns are made

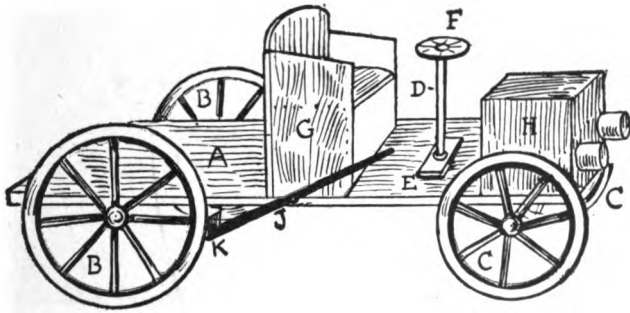

in the opposite direction above the hole, and the loose end tied to the other axle in front. When the steering gear is turned it will wind or unwind the wire, and thus turn the front wheels.

For the seat, *G*, get a strong box, about eighteen inches wide and as high as may be needed, and fasten with screws to the body. The front end should be partially removed and a board arranged so that the seat

may have a substantial back to lean against, as shown in the illustration. A smaller box, *H*, can be secured to the front to represent the engine of your push-mobile, and two old bicycle lamps may be placed one on either side. If there are no lamps, make-believe lamps can be improvised out of tomato cans with the paper taken off and the cans nailed in front of the box. A brake can be made by means of a stout stick pivoted at *J* near the seat and within reach of the hand. The lower end must extend back to the rear wheel and have a cloth-covered block at the end, *K*. By pushing the upper end toward the front, the rear end will engage the wheel and prevent its slipping. The entire mobile should be painted or stained and varnished. The seat can be upholstered as you may desire.

The apparatus is used as follows: One boy sits in the seat and manipulates the steering wheel, and the other boy pushes behind. When the mobile has sufficient momentum, he jumps on the rear and rides along. It is not safe to take too steep a hill unless you have a good brake on your back wheel, otherwise the machine may get away with you and you may come to harm.

## SIDEWALK COASTERS

A POPULAR and healthful exercise is furnished by a new toy which has taken the American boy by storm and which goes under various names, such as "roll-mobile," "sidewalk biplane," etc. It is a short board on wheels that is operated by standing on it with one foot and using the other as a pusher or propeller until a certain momentum is gained, when the apparatus slides along some distance by itself. For coasting down hill a little impetus sends it a great distance.

In its simplest form, Fig. 1, the apparatus can be made thus: Take a board fourteen to sixteen inches long and four inches wide, *A B C D*. Get an old pair of roller skates and take off the rollers. Attach one set of rollers to each end of the board at *E* and *F* securely by means of screws. If the skates are entirely of metal, it is well to cut the skate in half, bore four holes into the metal part of each set of wheels, and run screws through these holes. A blacksmith can easily do this



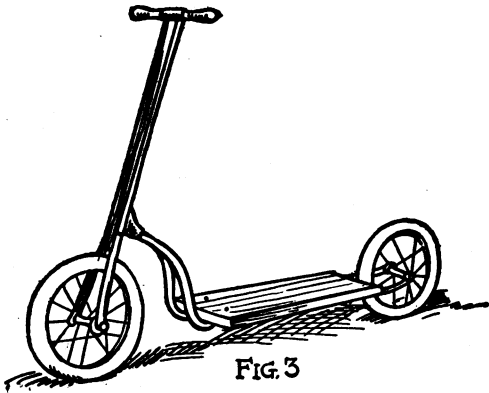
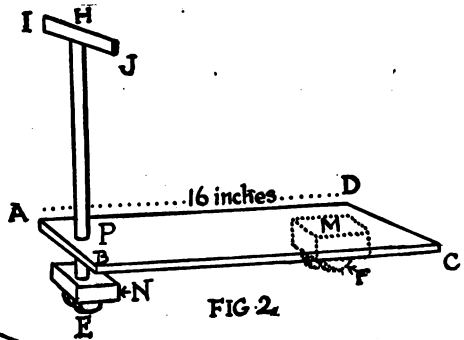
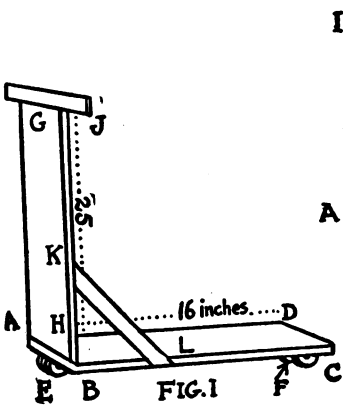

SIDEWALK COASTERS

at very little cost. Make an upright,  $G H$ , four inches wide, one inch thick, and twenty to twenty-five inches high, with a crosspiece,  $I J$ , at the top by which to steer. This crosspiece should be eight inches long. Attach this solidly, as there is great strain on it. The bottom of the upright,  $G-H$ , should be glued and screwed into the base at  $A B$ . It would be advisable to cut a groove into which the cross-stick shall fit exactly, as it will then be more secure. In running, place the left foot on the board and push with the right, holding on to the crosspiece  $I J$ . It might be well to brace the upright with diagonal pieces of wood or iron from the sides of  $H$  to the base, as shown at  $K-L$ .

A more professional way to make this roll-mobile is to have the upright movable to steer by, Fig. 2. In that case, the base is made as before. Make two blocks of wood,  $M$  and  $N$ , three inches square and two inches thick. Screw one,  $M$ , under the base and well toward the rear. On this fasten one set of rollers. Attach the upright, a stick one and a half inches square and thirty inches long, with a crosspiece,  $I J$ , at the top, to the other block,  $N$ , by cutting a square hole and inserting the lower end of the upright, gluing it securely. To the bottom of the block,  $N$ , fasten the other set of rollers. Make a hole,  $P$ , in the front part of the base,

where you want the wheels to be. This should be made with an inch and a half auger. The upright must be rounded where it goes through the hole, so that it will turn readily. Of course, the upright should be put through this hole before being fastened into the block. Now insert a peg or piece of wire into the upright just above where it enters the base at *P*, so that it can not slip up or down. By bearing on the crosspiece, *I J*, you can steer the apparatus in any direction, as the block follows the upright.

Fig. 3 shows a store-made roll-mobile. This is difficult to make as it requires strong metal wheels and braces. If you can obtain wheels of the right size, you can, perhaps, have a blacksmith make a frame to support them, as in the figure. A well-made wooden frame will usually answer all requirements. We offer the picture as a model from which the young mechanic may get ideas as to shape and detail.

## A COASTER WAGON

THIS is similar to the roll-mobile, except that it is made for one to sit instead of stand on, and can, therefore, be used only in going downhill. In construction it greatly resembles a sled on wheels. Here again an old pair of roller skates come in handy.

Get a stout board,  $A B C D$ , twenty-five inches long, fourteen inches wide at the back, and tapering to twelve inches at the front. Cut two sticks two inches square and sixteen inches long for the front and the back axles,  $E F$  and  $H K$ . Attach the back stick,  $E F$ , rigidly to the base an inch inside of the extreme end,  $A B$ . The second sixteen-inch stick is for the front and should be pivoted to the base at  $G$ , so that it will turn sideways. As the front is only twelve inches wide, the stick will extend two inches on either side. This is to rest the feet on when steering. Bore a half-inch hole in the center of the front stick or axle, and a similar hole in the base at  $G$ . Get a good bolt about three-eighths of

an inch thick with a screw nut and insert it in these holes, thus attaching the front axle, so that it can swing on the pivot thus formed, like the front axle of a car-

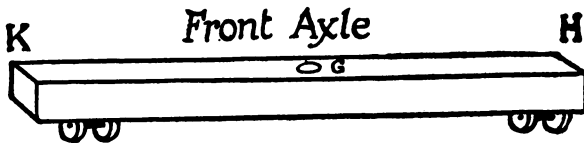
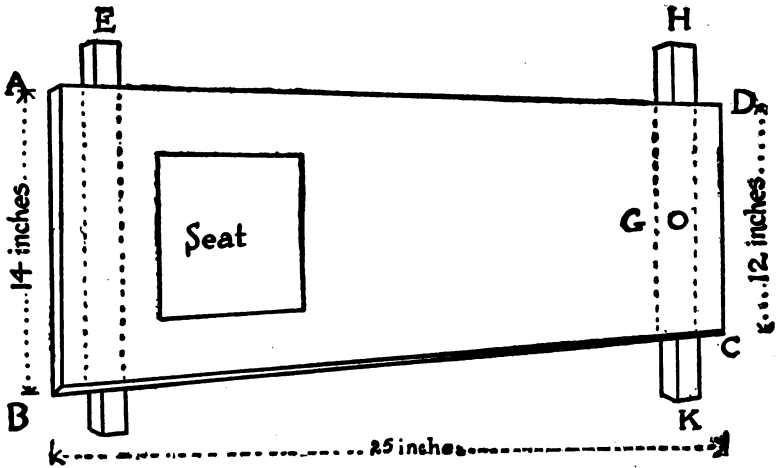

riage. In order to make a perfectly acting swinging joint, it is best to use two washers (round pieces of iron with a hole in the middle), one above, at the head of

the bolt, the other below, between the crosspiece, *H K*, and the nut. It is well, also, to place two more washers over the bolt between the board, *G*, and the piece, *H K*, in order to keep from pressing the two pieces of wood together, and to allow for a greased pivot. Because you want to have the crosspiece swing easily, you can not turn the nut down tight on the bolt. There is danger, then, that it will work loose and come off. To prevent this, it should be "locked." This may be easily done by using two nuts. As soon as you have turned the first nut down far enough to give a good easy-turning joint, put on the second nut, and turn it down upon the first. If you have two wrenches, twist one nut against the other, so that they are pressed tightly together. The nut is then locked, and will not easily turn off the bolt.

Now take your four sets of wheels and attach them firmly near the ends of the axles, at *E* and *F* for the rear, and *H* and *K* for the front axle. A cushion or a block of wood, *L*, ten inches square and firmly attached to the base by screws, will raise the seat and make it more comfortable. Care should be exercised in descending steep hills lest you lose control of the apparatus. Instead of steering with the feet, ropes can be attached to the ends *H* and *K*, and these be used

like those of the rudder of a boat, in which case it is best to have a foot rest on the base near *G*, to help brace the body and prevent falls.



## KITES

KITES are of various forms and sizes, and differ greatly as to lifting power.

The simplest form is that of a rhomboid or double triangle (Fig. 1), the frame of which is made by two pieces of light wood placed in the form of a cross. At the point of intersection, *E*, the two sticks are bound firmly in place by strong string. The ends of the cross, *A*, *B*, *C*, and *D*, are joined by strong twine. Tissue or other light durable paper is fastened smoothly over the entire front, the edges of the paper being turned over the string to which they are glued. A hole is made in the paper at *E*, and the end of a ball of twine is attached to the crossed wood.

The tail, which is necessary to keep the kite steady, can be made of a long strip of muslin, or of a piece of cord, with strips of paper tied across it at regular intervals.



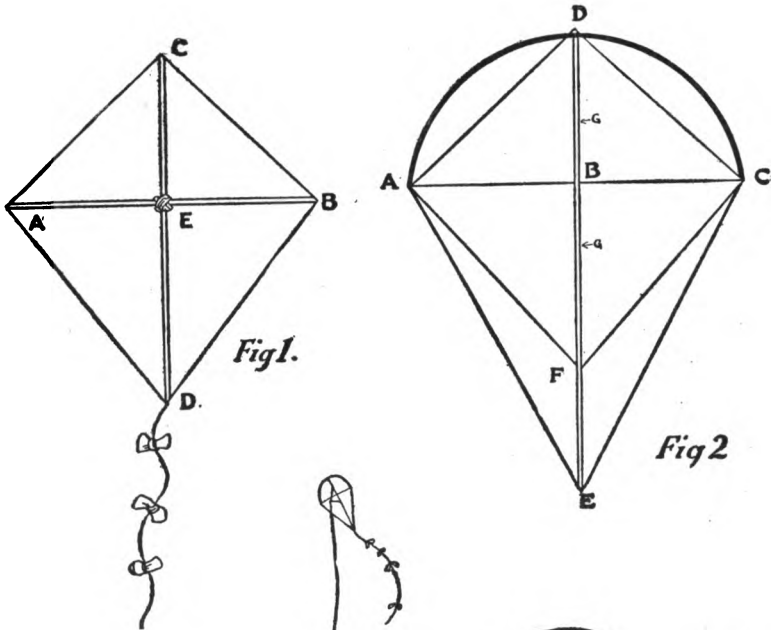

Another form of kite is as follows (Fig. 2): A straight piece of light wood forms the backbone, *DE*; the middle of a piece of thin hoop or pliant bough is attached to this at the top end by means of a string. Make a notch at each end of the crosspiece, *A* and *C*; tie a string to *A*, around the upright at *B*, continue it to *C*, then down to *E*, up to *A*, down to *F*, and up to *B*. This will give you a rigid framework, provided the string is drawn tight and firm. Next paste your paper upon this frame, doubling it securely over the string along the edge and the curved top. While mucilage may be used for this purpose, hot glue is altogether the best sticking material. Do not use white photographic paste, as it is useless on wood. Bore two holes in the stick at *G-G*, and to this attach you twine. The tail should be from ten to fifteen times the length of the kite. It is best made by tying to a string small rolls of soft paper at intervals of three inches, with a larger roll at the bottom of the string.

## TAILLESS KITES

THESE are easy to make and to manage. The longitudinal support, made of some light but strong wood, should measure sixty inches in length and be half an inch square. The crosspiece must be of the same general proportions and should be slightly bent. The frame should also be of light wood and covered loosely with strong durable wrapping paper so arranged that it will belly on the face of the kite on each side of the cross-sticks. This kite needs no tail and flies in a very light breeze. It is the best kite for flying in autumn.

Barrel kites were first tried in this country by officers of the weather bureau for experimental purposes, and with good results. A barrel kite is cylindrical in shape, about four feet long and two feet in diameter, and is made of four light wooden hoops braced by a number of thin uprights of wood. There is a twelve-inch space between the hoops at either end. This space is covered by strong paper. A stick runs diagonally through the

inside of the barrel from end to end. To this the cord is attached. The kite flies readily in a breeze and has a strong pull.

For kite string you may use common good stout twine, but for large kites in a stiff wind twisted linen twine is best. Tie good solid knots that can not come undone. There is a knack in tying knots properly that every boy should learn.

Flying kites tandem is great sport. Some tie several kites to the same string, one behind the other. A better way, however, is to have each kite attached to a string of its own, and attach these separate strings to the main cord.

Sending messengers up the string to the kites is lots of fun. Round disks of colored paper, with a hole in the center and a slit to enable you to slip it on the cord, travel upward till they reach the kite. Messengers have been sent up six thousand feet to kites that were being used by scientists to carry up thermometers and barometers for recording temperatures at high altitudes.

Kites have been used for many other scientific and useful purposes; for instance, to get a line from a stranded vessel to shore. When the first suspension bridge was built over Niagara Falls, a kite was used

to get a line across the gorge. To this line was attached a stronger rope, then a steel cable, and finally one of the great cables used to support the bridge.

Kites may serve advertising purposes also. A tandem string of them may be used to raise flags or banners with messages or to hold aloft a light dummy of a man hanging from a trapeze, for the bewilderment of the beholders.

## BOX KITES

BOX KITES are made on a foundation of four uprights, with supporting cross-sticks as braces at top and bottom, such as *A*, *B*, *C*, and *D*. Such kites can be made to any size. All the sticks must be light and strong, and securely fastened together with cord. The surface can be made of cotton material of a width one-eighth to one-quarter of the width of the kite. The material must be well stretched on the frame. Two strings of equal length are attached to the lower or inside corners, *E* and *F*, of one broad side of the cotton covering. These unite about two feet away from the kite, and to them the guiding cord is fastened.

This form of box kite was the forerunner of the aëroplane, and first suggested the possibility of soaring by means of heavier-than-air machines.

Flying kites has been a sport from earliest historic times. Among the Japanese it is the national pastime, indulged in by men as well as children, and they de-

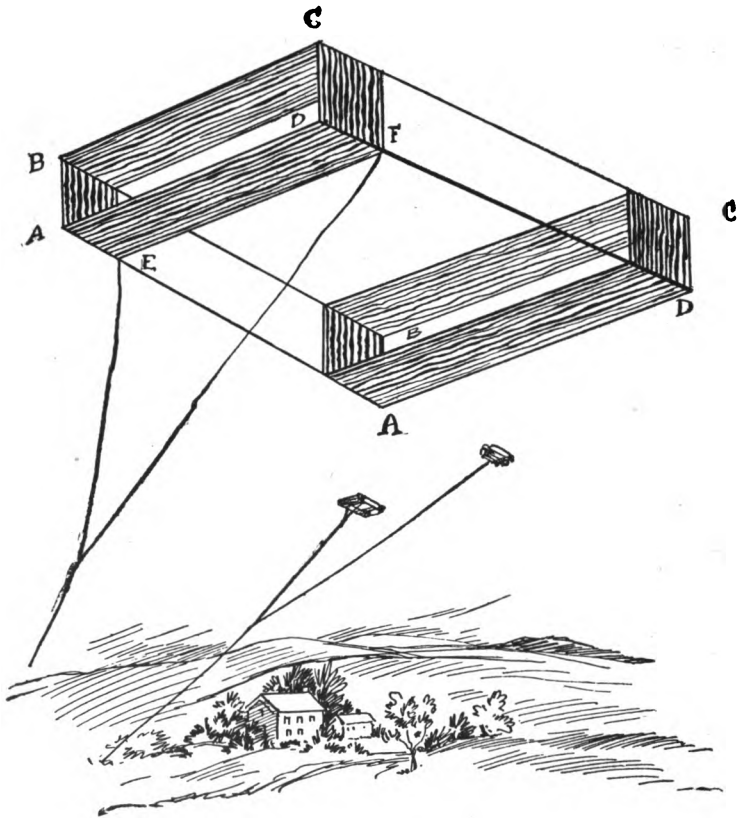

BOX KITES

velop great skill in handling them. The experiments of Benjamin Franklin, who drew electricity from the clouds by means of a key on a kite string are well known. That was the beginning of our entire electrical science. Franklin once sent up a kite, when going in bathing, and, lying on his back, allowed its power to draw him across the stream. Large kites have frequently been used to draw vehicles over country roads.

The principle on which a kite soars is, that, on account of its shape, the slant of its surface, maintained by the pull of the string, and its forward motion, the air currents lift it and hold it up in spite of its weight. Stationary kites must present a larger surface to the wind than kites that are drawn forward through the air, in order to make up for the forward motion. The heavier the kite the more essential is the movement forward. Thus the aëroplane falls to the ground if the motor power stops.



## KITE REELS

AFTER your kite is up in the air it is a laborious, not to say at times painful process, to haul it down. A reel is, if not a necessity, at least a very useful thing to own.

Get a box (Fig. 1) about sixteen inches long and eight deep, with a lid, which you must fasten on with two brass hinges. Two wheels are needed, the smaller one, *A*, about four inches, and the larger, *B*, six inches in diameter. The large wheel is attached to one side of the box by means of a screw and bolt, so that it will turn easily. It should be grooved along its entire circumference to the depth of a quarter of an inch. Near the circumference, at *F*, bore a hole, and into this insert a handle three inches long, made of a round stick. The smaller wheel has a center hole half an inch square.

An axle or spindle two inches longer than the width of the box must now be cut. It should be round throughout its length, except the one end that is to engage the small wheel. In each side of the box bore

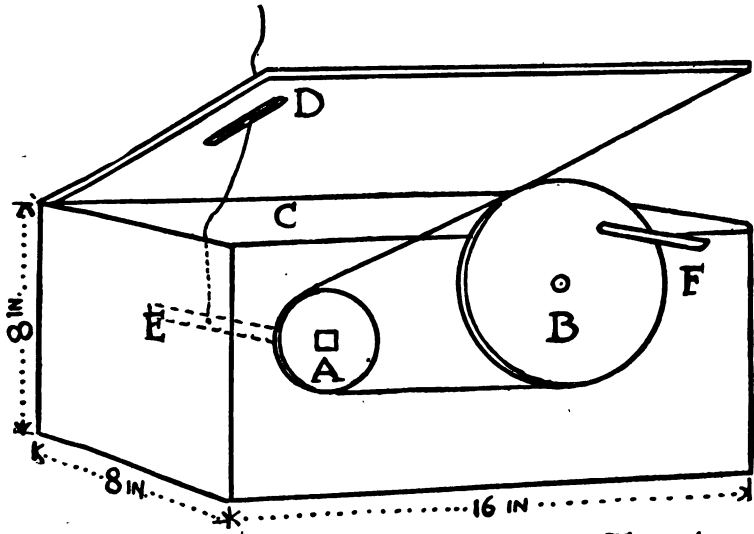

Fig. 1

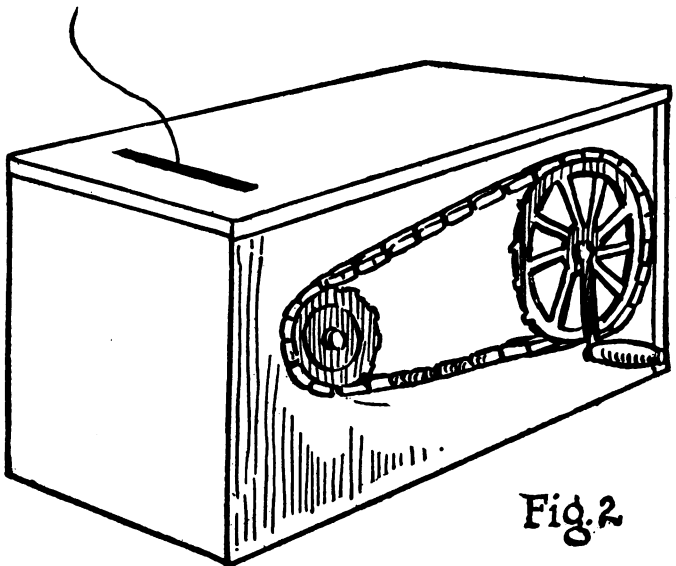

Fig. 2

a hole three inches from the end *E*,—that farthest from the large wheel,—and *midway the width*. These holes should be an inch in diameter. Through them stick the axle, letting the square end project through the side of the box upon which the large wheel was placed. The other end, which is round, must be fastened with a leather or metal washer, held in place by a screw. The square end of the axle is just large enough for the small wheel, *A*, to slip onto. It must be fastened with glue and nails. This small wheel also must be grooved.

The two wheels are now to be connected by a thin leather or cord belt, so that the power may be conveyed from one to the other. The kite line enters the box through a slit in the lid at *D*, directly above the axle, and the end is threaded through a small hole in the axle, *C*, and tied fast. By revolving the wheel *B*, the smaller wheel revolves and winds up the string. The lid should be closed during the winding process. The hole through which the string enters must be carefully rounded and sandpapered, or the string may be cut by rough edges.

A more intricate model is made with two metal sprocket wheels and a chain taken from a bicycle (Fig. 2). This will give greater power, but the wheels are not always obtainable.

## STILTS

THERE is no more enjoyable exercise for boys than stalking on stilts. It helps to develop the muscles of the legs and arms, teaches the valuable art of balancing, and creates no end of amusement. A race on stilts gives the keenest enjoyment to the onlookers, as well as to the participants.

The common form of stilts is easily made. Take two stout poles, *P*, about six feet long and from one and a half to two inches square, for the uprights (Fig. 1). The foot blocks, *C*, should be about four or five inches long, three inches wide, and as thick as the upright. Nail these two feet or more from the lower end of the upright, using strong steel nails or screws to keep them in place. A leather strap nailed to each block, and giving just room enough to admit the foot, will help keep the foot on.

An improvement over this simple form is that with movable foot blocks so that the position can be changed



Fig. 1

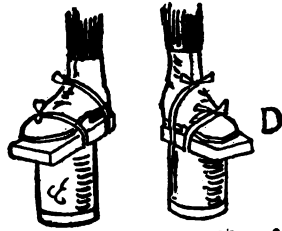
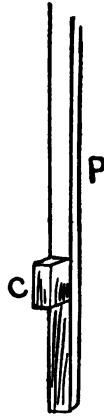

Fig. 4

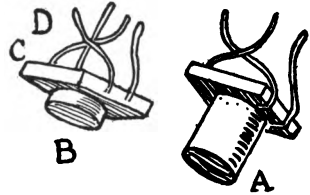

Fig. 3

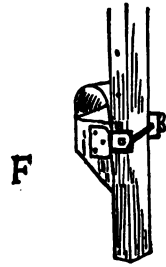

Fig. 2

STILTS

at will. The simplest way to make these is to get four bars of steel about four inches long, with four screw holes each, or, better still, four strong brass or steel hinges. Screw half of these to the blocks one on each side (and the other half must be fastened to the up-rights by means of stout wire or bolts). See Fig. 2.

Considerable fun can be obtained with tin-can stilts. Get two strong tomato cans, *A* (Fig. 3), without the tops. Cut two disks of wood to fit onto the tops of the cans. Screw these to blocks of wood long enough to hold the foot, as in *B*. Attach skate straps in such a way as to secure the feet, as in *D*. Then nail the can around the circular block and your stilts are complete (Fig. 4).

## TOPS

TOPS have a great fascination for boys and require skill and energy in their manipulation. They are easily made and amply reward the effort to make them. A metal wheel with a wooden peg through it is the simplest form. Wooden button-forms, as big in diameter as possible, with a stick through the center make good tops (Fig. 1). An acorn with a peg at the top answers very well (Fig. 2). To spin these it is only necessary to grasp the peg between the thumb and the index finger, and give a sudden twist. They will then spin on any hard surface.

Peg tops, like that in Fig. 3, are best made by means of a turning lathe, as they must be whittled down evenly to a tapering point. You can make one without the lathe, as follows: Take a cylindrical piece of wood one and one half inches in diameter. In the exact center of the lower end insert a piece of iron wire, allowing it to project one quarter of an inch. Work a

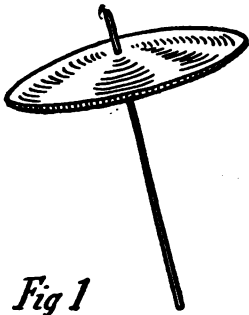

*Fig 1*

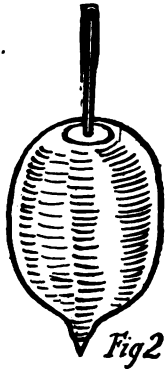

*Fig 2*

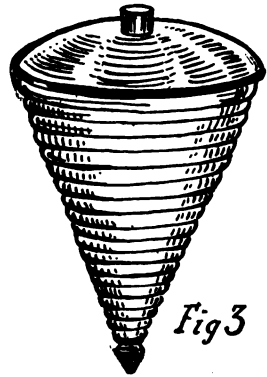

*Fig 3*

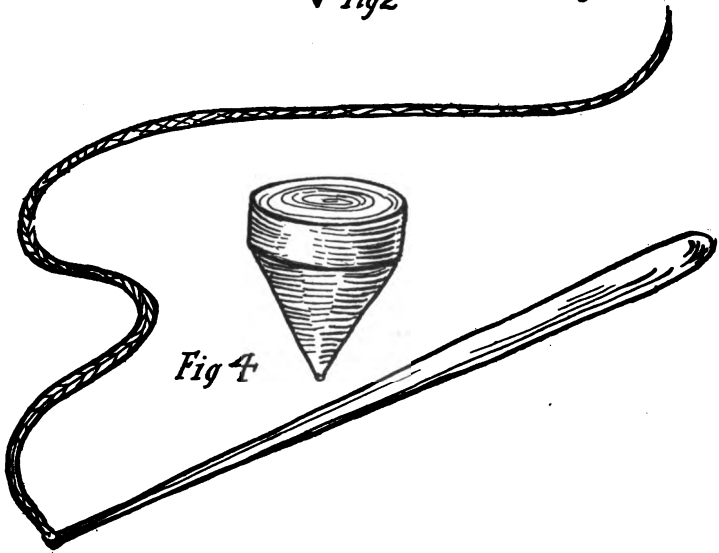

*Fig 4*



series of circles around the cylinder one quarter of an inch apart, and, beginning at the top, whittle the spaces between the circles so that each space will be cut out a little more than the space above it. In time the cylinder will take the shape of a cone with ridges, as in the illustration. The wire peg must then be filed to a point. A piece of strong cord two feet long is used to spin this top. At the end tie a shoe button to give a better grasp. Wind this about the top beginning at the point and proceeding upward till the whole top is covered. Hold the button between the middle fingers of the right hand, the tips of the fingers holding the top. Raise your hand in the air and cast the top with a downward sweep, while the string remains in your hand.

Fig. 4 shows a whip top, which is made in a similar way, although the upper half of the top remains cylindrical, while the lower half is whittled to a cone. The whip is made of a piece of a stick a foot long, to the end of which is attached a piece of braided cord or a thin leather strip. The top is twisted by the fingers and kept in motion by whipping it from time to time.

Other tops will suggest themselves to the ingenious mechanic.

## BOW AND ARROW

AMONG the favorite weapons of ancient days the bow and arrow takes first rank. The Egyptians and the Indians were both skilled in its use. With the invention of gunpowder the bow and arrow fell into disuse except as a toy or pastime.

You can make a bow by taking a strong elastic strip of wood, such as a barrel hoop or a branch of a willow tree, bending it into proper shape, and with a strong waxed cord uniting the ends. The arrows are straight, stiff, round sticks, which taper to a point and may have a horn or metal tip. The thicker end should have three turkey feathers tied to it, as in the illustration. These help to make it fly straight by offering resistance to the air.

A target may be made by forming a disk of straw and covering it with white paper on which a number of parallel rings can be drawn in red or black about a common center. Suspend this where the range is safe,

and shoot at it, trying to hit the bull's-eye. Archery is a fine sport, but care must be taken not to shoot an arrow

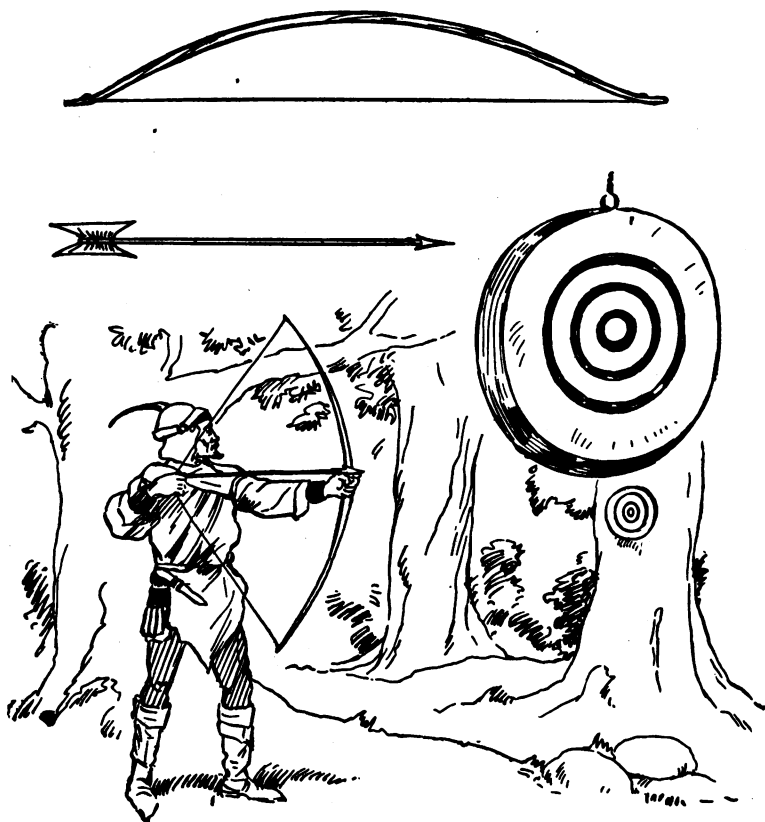

where it can injure a person or valuable property. The power of the bow depends upon the elasticity of the wood.

## A SUCKER AND THE PROCESS OF SUCTION

CUT out a circular piece of strong leather, *A*, three or four inches in diameter. Make a hole in the center,



through which pass a stout string about a yard long, *B*, with a big knot on the underside to prevent its slipping

through. Soak the leather well in water. When thoroughly wet, place the leather on a brick or stone, press it down quite flat, then take hold of the string and pull. The suction will raise a considerable weight.

The air above us weighs very heavy, but as the pressure is the same all about us, we do not feel this weight. By pulling the string of the sucker, a hollow space, or vacuum, is created between the leather and the stone. Then the weight of the air all around the stone and the leather holds together the surfaces surrounding the vacuum. The process or condition thus brought into play is called "suction." The same process is made use of in suction pumps, vacuum cleaners, and in many other machines and appliances.

The housefly and other insects can walk upon glass, and the barnacles can fasten themselves to ships, by means of suckers at the ends of their feet.

## SPRING GUNS

A SPRING GUN, which will shoot nothing more dangerous than a dart of wood or a pellet of paper, and that without the noise of explosion or the smell of powder, can be made in an hour's time, and will afford considerable amusement as well as an opportunity to learn to shoot straight, which is excellent training for eye and hand.

Here is a model that you can make in an hour's time. Whittle a piece of wood one and a half inches thick, eight inches long, and about four inches wide into the shape of a pistol, as in the illustration *A* (Fig. 1). To do this the rough outlines should first be sawed into shape and afterwards smoothed down with a knife. Make a slit through the thickness of the wood where the barrel begins, as shown by dotted lines at *B*, and into this put a trigger of thin wood about two inches long and half an inch wide. The longer end must stick out at the bottom, leaving only a quarter of an inch to project at the top. Fasten with a thin wire nail at *B*.

A wire spring or strong piece of rubber, *E*, should be attached to the lower end, and also to the stock at *C*,

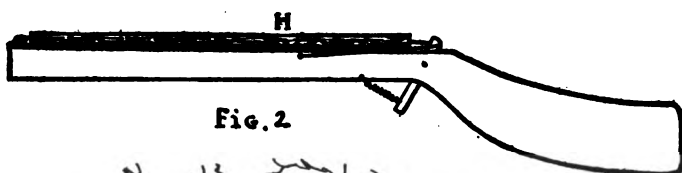
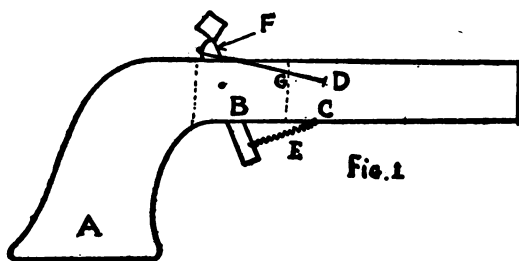

to pull the end of the trigger forward. Another rubber band or piece of elastic, *G*, is attached on the top, one

end on either side of the stock, as at *D*, so that the loop when stretched fits over the upper end of the trigger. This end should be slightly rounded so that the elastic loop can easily slip off. The lower spring or rubber must of course be stronger than the upper, to keep the trigger as shown in the cut. Just an inch beyond the trigger, at *F*, cut a narrow slit with your knife. For ammunition stick a piece of cardboard about an inch square into this slit with the point down. If you pull the trigger back, the rubber will slip off the top end of the trigger and shoot the paper dart with considerable force.

A variation of the idea is to make the weapon in the shape of a gun (Fig. 2), about eighteen inches long. Get a tin blowpipe, *H*, about six inches long, and fasten it to the barrel by means of thin wire or small staples. The ammunition is a long thin stick or dart, which is inserted into the tube and made to extend out at the back to within an inch of the trigger. The arrangement of the rubber and the spring is the same as in Fig. 1. On releasing the rubber the trigger strikes the protruding end of the dart and sends it through the tube with a speed depending upon the strength of the rubber. The gun may be stained brown and varnished.



## TIP-CATS

TIP-CAT, or "Pussy," is a favorite game with boys and is to be recommended for the exercise it affords the arm and the training of the vision as well.

It is played with a piece of wood about five inches long and about one and a half inches thick, which tapers to a point at each end. This is called the "cat." The players are each armed with a strong stick twelve to fifteen inches long. When the cat lies on the ground a smart blow with the stick on either end will send it up into the air. Before it falls it must be struck with the stick and batted to as great a distance as possible.

There are several ways of playing this game. The simplest is to make a ring upon the ground, place the cat in the middle, and try to bat it out of the ring. If the player fails, he is out, and another player takes his place. If he bats the cat out, he measures the distance from the center of the ring with his stick, and scores accordingly. Instead of measuring at once, the dis-

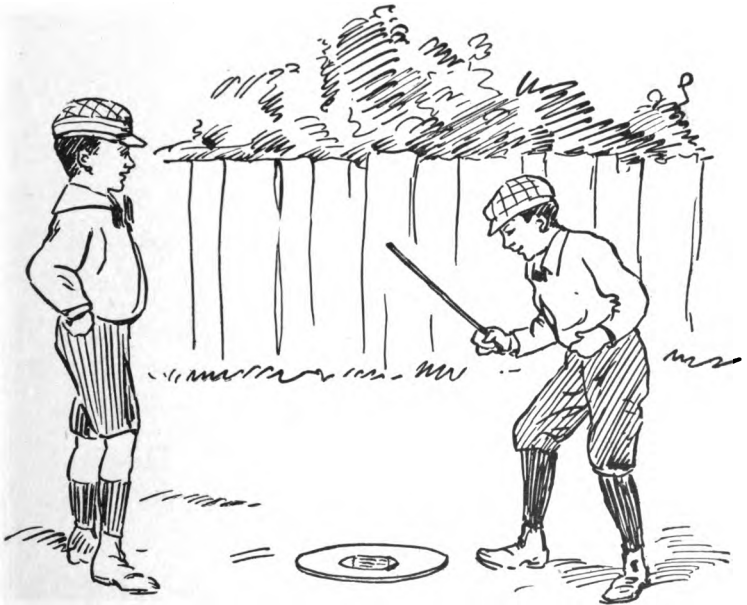

PLAYING TIP-CAT

tance is often guessed at. Then the stick is used to measure, and if the guess is greater than the actual distance, the player loses one from his score. If, on the contrary, the guess is within the distance, he adds one to his score.

Another way to play the game is to have four, six, or eight holes arranged in a large circle with a player at each hole. The game is to bat your cat to the next player and so on around the circle.

## A PRETTY DOLL'S-HOUSE

IN SPITE of the high rents asked by landlords, there is no reason why the dolls of the family should not live in a beautiful house with many comforts. In fact, if you are careful, you can build a home for the pet doll that will be the equal of any millionaire's home, and at only a fraction of the cost. Here's a simple way of going about it.

Determine first of all how many rooms the house is to have, and then get that many boxes from the grocery or the dry-goods store. Soap boxes, shoe boxes, or even cloth cases will answer, according to the size you wish the complete house to be. The boxes should be of uniform size, or at least of uniform height. As there are any number of combinations of rooms, we will confine our description to a four-room house—one containing parlor, dining-room, bedroom, and bathroom. Other rooms can be added at will.

Take your four boxes, *A*, *B*, *C*, *D*, and nail them

together two and two, one pair above the other, as shown in the illustration. You have thus a simple layout that will suit almost any doll. The roof is made of compo-board or matched boards held together by

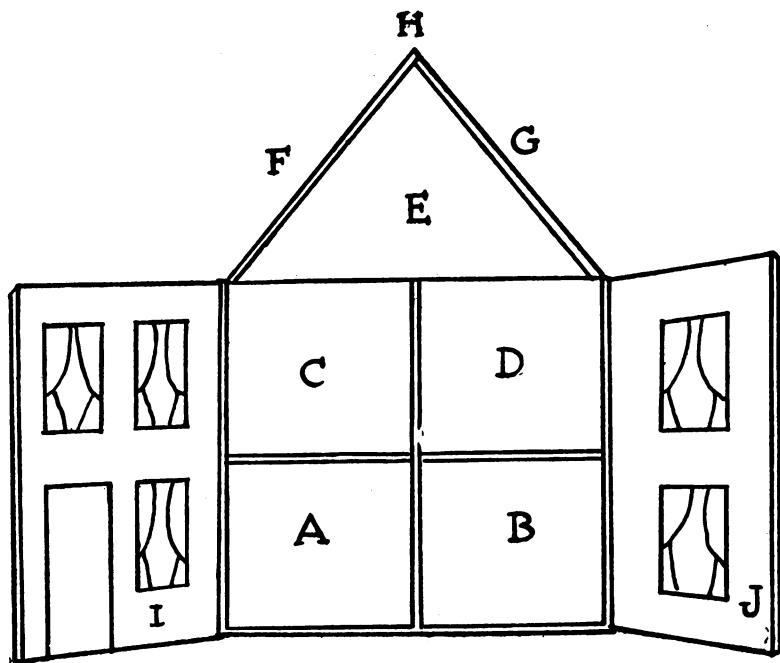

battens. It should be in two pieces, *F*, *G*, large enough to extend an inch over the edges of the boxes. The upper edges must be beveled and joined in a peak, *H*, about a foot above the top of the boxes. A triangular

piece of the same board, *E*, must then be cut and fastened in the opening made by the roof, and a similar piece fastened in the rear under the eaves.

The front of the house is also made in two sections, *I, J*, hinged at either side and so matched that they will

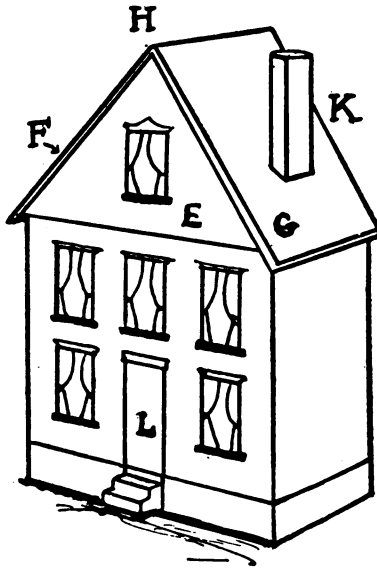

come together tightly in or near the center. In these sections you must saw the door and the windows. The windows can be of any suitable size, but four by five inches is most convenient, because you can then use for panes the glass used for camera plates. The windows and door can be cut out with a scroll saw. The glass

is held in place by thin brads, or is pasted to the wood with strips of paper. Trimmings of cigar-box wood can be glued above and below for the sills and frames, and other ornamentation may be added. The door, *L*, is made of the lid of a cigar-box and is hinged in place by pieces of muslin glued to the back. An upright block of wood, beveled to fit onto the roof, forms the chimney, *K*.

The painting of the house is easily done. A brown paint with sand strewn over it while it is still wet, makes a very good imitation of a brownstone house; or, if Dolly prefers, red paper marked with the outlines of bricks can be bought of some stationers and the house converted into a colonial brick mansion. A flight of two or three steps can be made before the front door.

Of course this house may be changed and improved in many ways as the work goes on. If you have six rooms, there can be a kitchen and a spare room. The triangular front of the roof, *E*, can be made to open and a bedroom for Dolly's servant can be fitted up in there.

The question of furnishings is a very important one. Good furniture can be bought at any toy store, but if you prefer to make your own furniture, you will find detailed instructions in the next chapter.

The walls should be papered. Any paper-hanger will give you enough for the purpose. The parlor and dining-room should be of some rich, dark color, while that of the bedrooms should be light in tone. Lace curtains, made from mother's rag-bag treasures, are easily attached above the windows with tacks or glue. Carpets or rugs are a necessity. There is usually enough carpeting lying about in any storeroom to serve your purpose. Rugs are more sanitary than carpets, and do not have to be nailed down. If Dolly is stylish, by all means give her rugs. The ceilings should be painted white. Pictures for the walls can be cut out of a picture book or magazine. Portières for the doors can be made of any kind of goods that is convenient, although they are no longer considered sanitary, and Dolly's health is the first consideration.



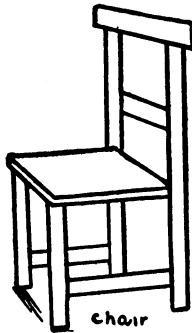
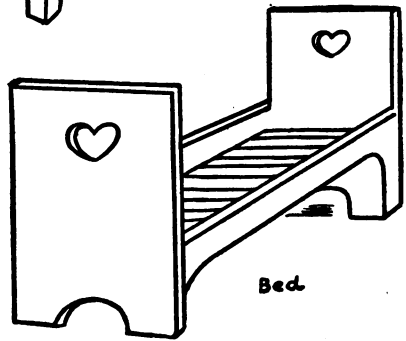
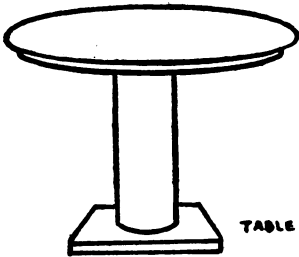
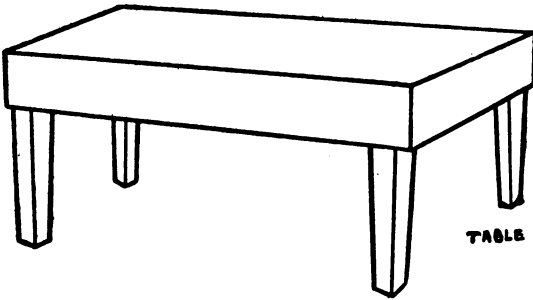

DOLL'S-HOUSE FURNISHINGS

## DOLLY'S HOUSE-FURNISHINGS

A GOOD material for making furnishings for Dolly's house is cigar-box wood. A scroll saw is the most useful tool for cutting the wood, but if that is not at hand, a good sharp knife, a file, and a chisel will answer. Soak the wood in water to loosen the paper labels and stamps, and be sure that it is perfectly clean. It is well to make your design on paper first and then trace it onto the wood. This makes it easy to cut two pieces alike, as the two sides of a chair.

The illustrations give a number of designs of chairs, tables, etc. It will not be necessary to repeat the direction for joining the parts in every case. The backs, sides, etc., should be glued together, using thin brads also, wherever possible, to hold them securely. By observing the furniture in your own rooms, you will get a better idea of what to make and of the shapes of the various articles than could be conveyed by illustrations. Every piece should be varnished or painted the color desired. Dishes for the kitchen had best be bought at a toy store, for it is difficult to make metal utensils properly.

## CIGAR-BOX TOYS

A SCROLL saw is very useful in making things out of cigar boxes. If you try to split the wood, it is apt to make a crooked or slanting edge. Get boxes of various sizes, and remove all the paper by soaking them in water and scrubbing. In most cases you can use the boxes without much alteration, and the number of toys you can make is only limited by your ingenuity.

To make an express wagon, use a shallow box, *A* (Fig. 1), for the body. Cut out two wheels about two and a half inches in diameter for the front set, *B*, and 3 inches for the back set, *C*. The wheels should first be marked out with a compass and then sawed out with a scroll saw. A small hole in the exact center of each is necessary to attach them to the axles, *D*. These axles can be cut out of the lid of the box, after the shape shown in the illustration, the front one being a half inch higher than the rear. Fasten them to the body by means of several thin nails driven through the bot-

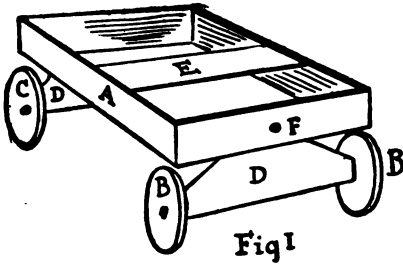

Fig 1

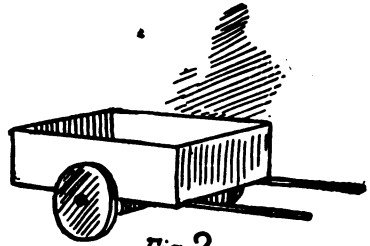

Fig 2

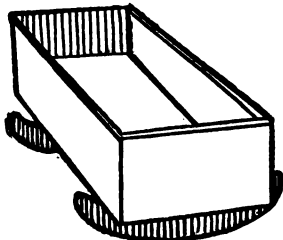

Fig 3

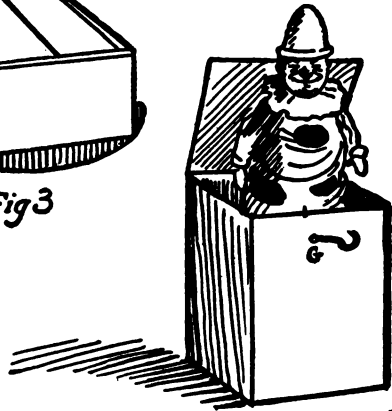

Fig 4

tom. The wheels are then fastened onto the ends by means of long thin nails that will allow them to revolve easily. Fasten a string to the front at *F*, to pull by. For a seat, *E*, cut a piece of the lid long enough to go from side to side and as wide as the box is high. A back of the same material can be glued on if desired.

To make a cart (Fig. 2), use the same methods, except that there is but one pair of wheels. These should be fastened below the middle of the body. Two thin shafts, about an inch wide, can be cut from the lid, and these can be fastened to either side of the lower part of the body, as in the illustration.

To make a cradle for Dolly (Fig. 3), use a box for the body, and out of the lid cut two rockers long enough to extend beyond it an inch on either side. These rockers should have a rectangular piece cut out from the center of their upper edge, so that the body of the cradle will fit in. The illustration gives the idea, which is easily understood.

To make the rockers, cut the lid in two equal-sized pieces by sawing along (not across) the grain of the wood. Each piece should then be cut carefully to the right length to fit across the box, leaving ends protruding at either side, as in the figure. To get the round shape of the rockers, find the middle of the piece of

wood, then from a point on a line drawn at right angles to the length, take a center, from which a curve from one end of the piece to the other may be drawn with a pair of compasses. The curve may then be cut with an ordinary jig saw, or, with care, and by not trying to cut too much at once, with a sharp pocket knife. The curve of the second rocker may then be marked out by running a pencil around the cut on the first. If marking out the curve with compasses is too difficult for the beginner, the curve may be traced by setting a round can or pan over the piece of wood, and tracing around with a pencil. In either case, it is necessary to get the two curves as nearly alike as possible. If, after the curve has been marked out on one rocker, the two pieces are tightly clamped together on the bench, as by a longer piece laid across them and screwed into the bench, the curve may be cut for both of them at once with a sharp chisel, being careful to take off small cuts, in order not to risk splitting the wood. As cigar-box wood is very likely to crack, be careful about driving even small nails into it, also about cutting or shaping it. Only a fine-tooth saw, or the sharpest knife or chisel should be used on it.

A Jack-in-the-Box (Fig. 4) is an amusing toy and is made as follows: Get a box as near cubical as pos-

sible,—the kind that holds twenty-five cigars. Hinge the cover with strong muslin and glue it onto both box and cover. Then put a tack in the center of the front edge. A little under this on the front of the box fasten a hook, at *G*, so that the lid can be held down securely.

Jack himself is made of an old doll's head and a coil of springy wire. You yourself can make the spring out of a piece of steel or brass wire wound around any kind of a cylinder. Attach one end of this to the doll's head and the lower end by means of tacks to the bottom of the box. A loose piece of calico or colored cloth must encircle the spring to represent the dress, and a cap must adorn Jack's head. Press the head down into the box and fasten the lid. Jack is now ready to surprise any inquisitive person who opens the mysterious box, by springing at him savagely.

Chairs and tables out of cigar-box wood are easily made and have been already described. Spools can be used to good advantage in connection with cigar boxes to make wagons, carts, coasters, etc.

## WAGONS AND WHEELBARROWS

UNLIMITED fun for the small boy is obtained from express wagons and wheelbarrows, and, while they may be bought at a low figure, the enjoyment is doubled when the owner has made his own vehicle.

Naturally, the most important part of a wagon is the wheels. If there are any old wheels about the premises from former wagons or baby carriages, you can, of course, use them. If not, you must saw your own wheels out of half-inch board, *A*. Get them perfectly round, the size desired, and sandpaper them smooth. The front wheels should be one-half smaller than the back wheels, in order to allow them to turn under the body of the wagon in going around a corner (Fig. 1).

The axles are sticks about two inches square and at least three inches longer than the width of the wagon. One inch in length at each end is to be rounded down to one inch in diameter, *C*, and the hole, *D*, made in the exact center of each wheel, must be a little larger,



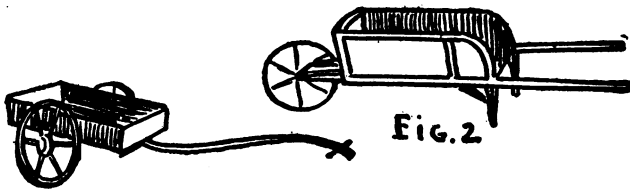
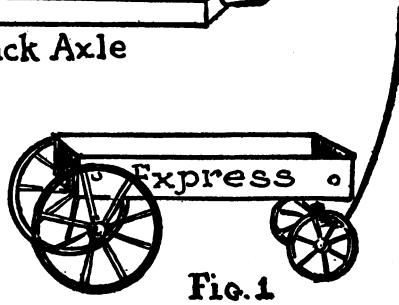
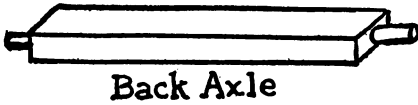
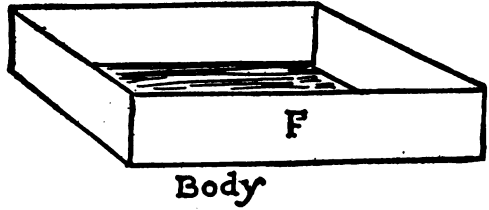
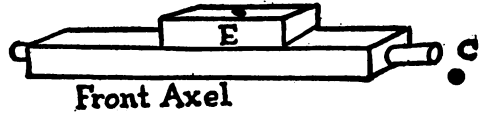
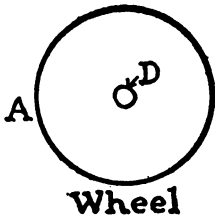

WAGONS AND WHEEL BARROWS

so that the wheel will turn on this axle. A disk of tin or leather secured onto the end will keep the wheels in place. Where you have ready-made wheels, the axle must be rounded down till it fits into the hole in the center of the wheel. When baby-carriage wheels are used, you will save work by having an iron axle.

The axle of the front wheels is considerably lower than that of the rear wheels, and a block of wood, *E*, must be made about three inches long, one and a half inches wide, and high enough to make up the difference between the two levels. This must be screwed onto the front axle. A hole bored into the middle of this should be in line with a hole in the body of the wagon, and a wooden peg or iron bolt will hold the two together so that the wheels will turn freely.

The body of the wagon, *F*, can be any suitable wooden box, or you yourself can make a box by gluing and nailing together the necessary boards. The tongue or shaft may be a single stick about three feet long, attached by means of a screw or staple to the front axle; or it may be a double shaft into which to hitch a dog or goat.

A wheelbarrow (Fig. 2) has only one wheel, which is centered on an axle in the rear, and in front has two shafts with handles.

## A TROLLEY ROAD

ALL aboard for Oshkosh, Kankakee, and Kalamazoo! There's no reason why you should not own your own motor-driven trolley-car system and pose as a railway magnate. It's as easy as rolling off a log. A few cigar boxes, some big spools, and a little ingenuity are the main things required. Of course the system will be only a toy, but Dolly can take a ride, and in your imagination you can have it all as big as you please.

The important parts are the car, the track, and the supports for the trolley. The car can be made out of a big cigar box, *D*, stood up on its narrow end, if you want a narrow car, or on its bottom, if you want a wide car. If a cigar box doesn't seem large enough for your idea of a car, get a shoe box. The wheels can be made of spools or spindles, the kind that ribbon is wound on, *H*. These can be obtained at any dry-goods store.

Our illustrations show the car made of a cigar box. The truck, *A*, should be made of a piece of half-inch

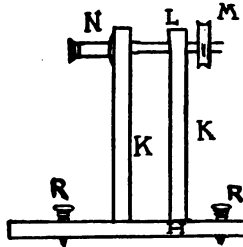
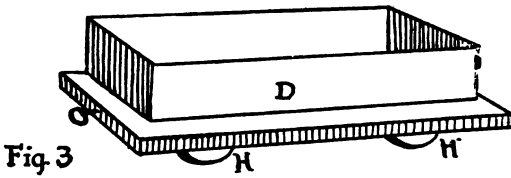
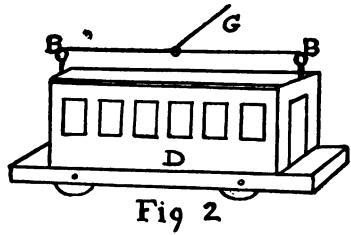
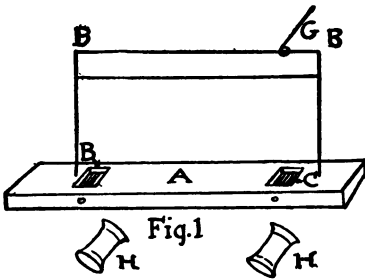

Fig 4

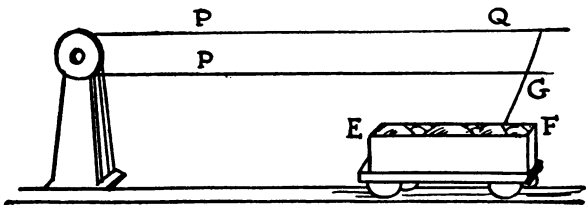

Fig 5

board two inches longer than the box, so that it will extend one inch at each end. Make two rectangular holes, *B* and *C*, in this truck two inches from the ends. They should be just large enough for the spools to slip into easily, in the position shown in the illustration. Bore holes through the base corresponding with the holes in the spools, and through these stick long wire nails, or pieces of wire, to act as axles for the wheels. Now place your box, *D*, on the truck, but not immediately on top of the wheels, or they will not be able to turn. Make two blocks about an inch long and high enough to escape the wheels. Glue these immediately before the front and behind the rear wheels, and glue the box to them.

The car can have windows and doors painted on the sides and ends to represent the real thing. On the roof, screw in two long screw-eyes, one at each end, as *B B* (Fig. 2). Stretch a piece of strong wire from one to the other. Tie a strong cord, *E*, to a brass ring, and slip this ring on the wire so that it will slide easily. The other end of the cord is to be attached to the overhead trolley wire and will serve to guide the car.

If you prefer, you can make the body of the car out of cardboard, painted to represent a real street car (Fig. 2). It should have the edges glued together, and

can then be mounted instead of a cigar box on the wooden truck. A flat or gondola car for hauling freight can be made by turning the cigar box over, so that the sides are low instead of high (Fig. 3).

The uprights that hold the trolley wires are made as follows: Make two bases of one-inch-thick board a foot long and six inches wide, *H*. Make four pieces of similar board six inches wide and nine inches long, *KK*. Two of these are to be nailed to each base, as shown in Fig. 4. Bore a half-inch hole through the uprights an inch from the upper end. Through these goes the shaft, *L*, that holds the wheels. This can be whittled from a stick, and should be round and long enough to go through both supports, *KK*, and extend an inch beyond each. The power wheel, *M*, can be sawed out of a board, and should be three inches in diameter. It must be grooved so that a cord belt can be held in the circumference without running off. The wheel must be attached by glue to one end of the axle. At the other end fasten a small spool, *N*. This is to serve for the belt that connects with the source of power, which may be a water wheel or clockwork. Make a duplicate of this arrangement for the other end of the tracks.

Place these bases with their uprights as far apart as

the length of the room will permit. Weigh them down, or fasten them in some secure way by screws or nails to the floor, *RR*. Get a long cord, *PP*, that will extend from wheel to wheel, around each, and back in an endless loop. Attach the cord on top of the car by a knot to this cord, *Q*. When the belt moves it will carry the car along with it.

The tracks can be made of thin strips of wood or frame moulding glued or otherwise fastened to pieces of cardboard. They must be the same distance apart through their entire length, that distance to be gauged according to your car wheels. The various sections of track can be fitted together along the floor by lapping the ends of the cardboard over each other. Railway stations and other paraphernalia can be made to suit the tastes of the young mechanic.

To operate the car, start up your engine, water wheel, or whatever power you have geared up to the spool, *N*. The trolley cord will then begin to move and will carry the car with it. When the car cord reaches the limit of track it will revolve around the wheel and the car will be pulled back again to the starting point. Improvements will suggest themselves as the work proceeds.

## A PRIMITIVE FLYING MACHINE

LONG before aëroplanes were invented boys made "flyers," which soared high into the air and gave promise of greater aviation when the laws of nature should be better understood. To make a flyer is not difficult. It consists principally of a stick and a spool. Get a good-sized thread spool, *A*, and into the top end drive four thin wire nails, making an even square around the center hole, *B*. Have the nails project half an inch and file off the heads so that the tops may present sharp points. Make a round stick about six inches long and half an inch in diameter, *C*. Shave or whittle the upper end, *D*, for about two inches down, so that it will be thin enough to slide easily in the core of the spool.

The flyer itself should be made of strong, thin cardboard or sheet tin. Cut a circular piece five inches in diameter. Lay out on it a curved cross, *EEEE*, as in Fig. 2. This can easily be traced with the aid of a ruler



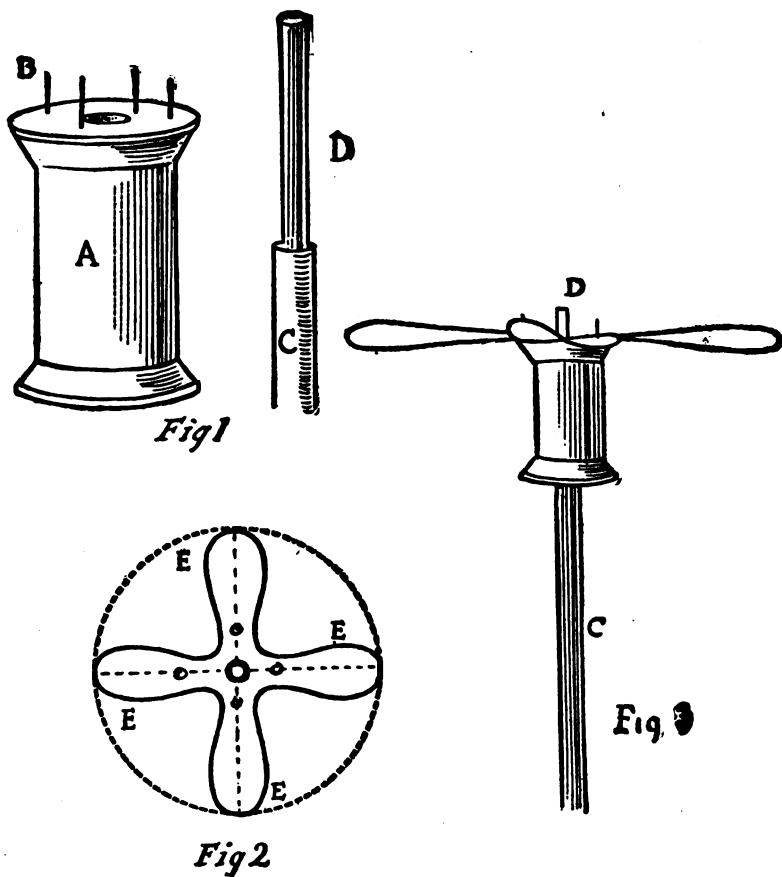

A PRIMITIVE FLYING MACHINE

and a compass. The four parts must be accurately drawn and carefully cut, or they will not balance. In the center make a hole large enough to slip easily over the smaller end of the stick. Also make four small holes that will fit exactly over the four pins in the spool. Bend the ears of the cross so that they will incline all in the same direction, like the blades of a propeller, and be at an angle of about 45 deg. or one-half a turn around, with the top of the spool when in place.

Place the flyer over the end, *D*, of the stick, with the pins sticking through the holes and the center lying flat on the spool (Fig. 3). The ears will then incline upward. Wind around the spool a strong string, with a loop at the end through which to hook your finger. Give the string a vigorous pull and the centrifugal force will send the flyer soaring up into the air, revolving rapidly. A height of a hundred feet or more can be reached by this toy, if it is properly constructed.

## A TOY MOTOR BOAT

A REAL motor boat requires for its equipment complicated machinery, and it is not within the scope of this book to go into the details necessary to make one. There is, however, no difficulty in making a boat that will skim along the water by its own power, and carry Dolly on an excursion to foreign shores. It may be made of wood and be carried along by a propeller run by a rubber-band motor.

The bottom of the boat, *A*, should be cut out first. Take a piece of board an inch thick, three inches wide, and eighteen inches long. Cut it square at one end for the stern, and taper the other to a sharp point, beginning six inches from the stern. Fig. 1 will give the appropriate shape and dimensions. The board must be carefully sandpapered and the edges made even. The sides, *B*, and stern of the hull are made of quarter-inch strips of wood that can be bent. They should be three inches wide, or wider, according to

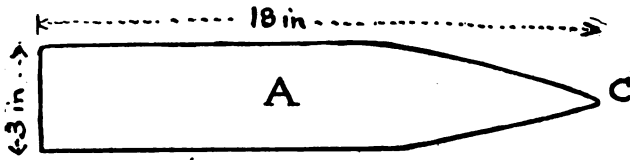

Fig 1

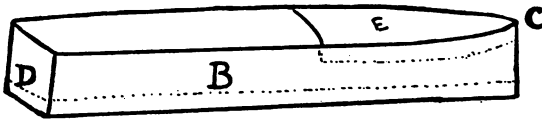

Fig 2

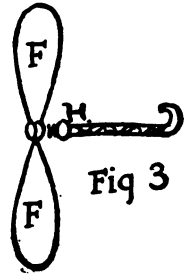

Fig 3

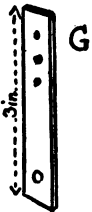

Fig 4

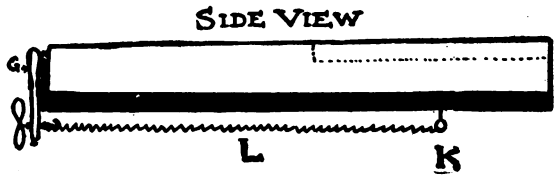

Fig 5

the height you desire the boat to be. These must be nailed along the edge of the bottom, one one each side. Where they meet at the point, C, they must be carefully beveled so as to make an even joint. At the back,

*D*, fix a piece of the same thin board, three inches long. Nail this to the bottom and the side pieces to form the stern of the hull. All the joints should be carefully puttied or the edges covered with thin tin, so as to make them water-tight.

The forward half of the hull should be covered with a deck, *E*. This can be made of a thin piece of board cut to a point to match the outlines of the hull, and just wide enough to fit between the sides. It can be tacked or glued in, and should extend a third or half of the way back.

The propeller shaft, *H*, consists of a straight piece of wire from two to three inches long. The propeller, *F F*, may be cut out of a piece of tin. It must have the shape shown in the cut, similar to an electric fan. In length it should be from three to four inches and in width about three-quarters of an inch. The blades must be bent at the proper angle, both blades being at the same angle. Two small holes near the center, one on each side, will serve to stick the wire shaft through. It must be put through one hole, the two ends then bent around so that it will go back through the other hole, and be twisted together in such a way that it will hold the blade securely.

Cut another piece of tin, *G*, for the bearing plate.

This should be three inches long and an inch wide. Near the lower end make a hole large enough for the wire shaft of the propeller to go through. Tack this tin onto the stern of the boat, *D*, so that half its length will extend below the boat. Slip a bead, *H*, over the wire shaft next to the propeller (Fig. 3), to keep it from rubbing against this plate. Make a hook on the free end of the shaft for the rubber bands. The rubber bands, *J*, should be one and one-half inches long, and strong. Loop them into each other, end to end, to form a continuous strand. Put a small screw-eye, *K*, into the bottom of the hull an inch from the extreme front point (Fig. 5). To this loop one end of your rubber, *L*, and hook the other end into the hooked part of the wire shaft. It will take three or four strands of rubber to get the proper strength. Instead of looping the rubber together, you may take four or five bands of rubber elastic half as long as the boat, and hook them as described.

To wind the motor, hold the boat with one hand and the propeller, *F*, with the other, and give the screw a hundred or more turns. Keep hold of it until your boat is launched, then let go. The boat will skim along for quite a distance, according to the strength of your rubber and the size and the angle of your propellers. A rudder is not necessary.

## A PANTOGRAPH

A VERY practical and useful instrument for drawing is called a "pantograph." It is used by many architects and designers in copying plans and in enlarging or diminishing pictures. It is also used in many machines, such as embroidering looms, etc.

To make one, take four thin sticks of wood not over a quarter of an inch thick, but half an inch wide, two of them nineteen inches long, and the other two eighteen inches long. The longer ones must have a hole about the size of a lead pencil bored an inch from each end. The other two have such a hole at only one end. Besides these holes, smaller holes half an inch apart must be made with an awl the entire length of all the sticks. Make the pegs pointed at the bottom and narrower in diameter halfway up, like *P*. Join the two shorter sticks by inserting the small end of one of these pegs into the large hole of each, so that the peg point will stand upright upon the table, as at *D*. The

other peg joins the longer sticks together, as at *B*. Make a small block of wood, *Q*, half an inch thick and two inches square, as a support for the free end, *A*, of one of the long sticks. A screw-eye goes through the hole, at *A*, and through the block, fastening it to the

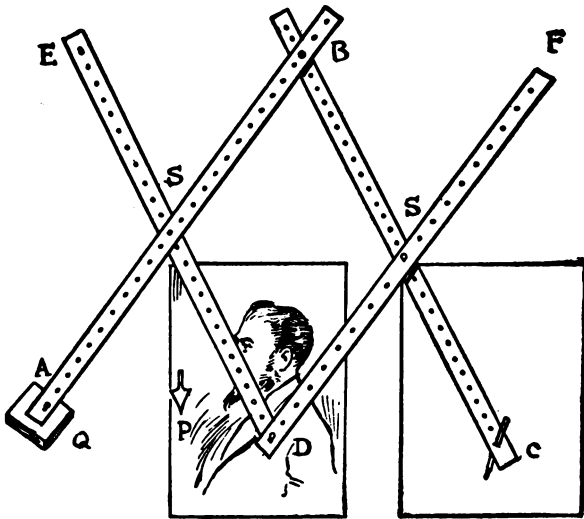

table. A lead pencil must be inserted through the hole in the free end of the other long stick at *C*. The two pairs of sticks are joined together, as at *S* and *S*, by screw-eyes, which can be taken out or put in at will. By varying the position of the screw-eyes through any two corresponding pairs of holes, the size of the reproduction is changed.



To use the pantograph, attach the block to the table, as described above, so that it will not move about. Place the picture to be duplicated on the table so that the peg uniting the short sticks, at *D*, can be moved over all parts of the picture freely. The end of the pantograph having the pencil, *C*, will move in unison with the peg *D*. Hold the top of the pencil, *C*, in your right hand, bearing on lightly, while you trace the outlines of the picture with the peg point. The pencil will make lines exactly like those that the peg has traced. If the points *S* and *S* be midway the sticks, the pencil will trace the picture in its original size; otherwise, the tracing will be larger or smaller than the original, according to the distance that *S* and *S* are from the free ends, *E* and *F*.

## A CAMERA OBSCURA

THE illustration gives two forms of the camera obscura. The first is used for tracing (Fig. 1). It consists of a box, *A*, two feet long and one foot square at the ends. The illustration shows one side removed, but in reality the box must be entirely closed, except that half of the top, *C*, must be sawed out and hinged on so as to form a lid. In the opening put a piece of white ground glass, *G*. Under the glass is a mirror, *E*, as wide as the box, placed at an angle of  $45^\circ$  with the glass so that it will reflect upward. In the front end, *K*, of the box saw a round hole three inches in diameter. Into this stick a tin tube, *B*, a foot long, just big enough to go into the hole and slide easily. You will then have to get a lens, *D*, large enough to fill the other end of the tube. A telescopic lens is what you need.

The apparatus is now complete. The lens is focused by sliding the tube, *B*, into the box or pulling it out. Any object placed before the lens is reproduced

on the mirror, which reflects it onto the glass, *G*. The eye, at *G*, sees the picture, inverted, but in its original colors. The picture can then be traced on the glass or on thin paper. The lid, *C*, serves to keep off any direct light. A cloth about the head of the observer, to cut off outside light, will make the picture more distinct. The

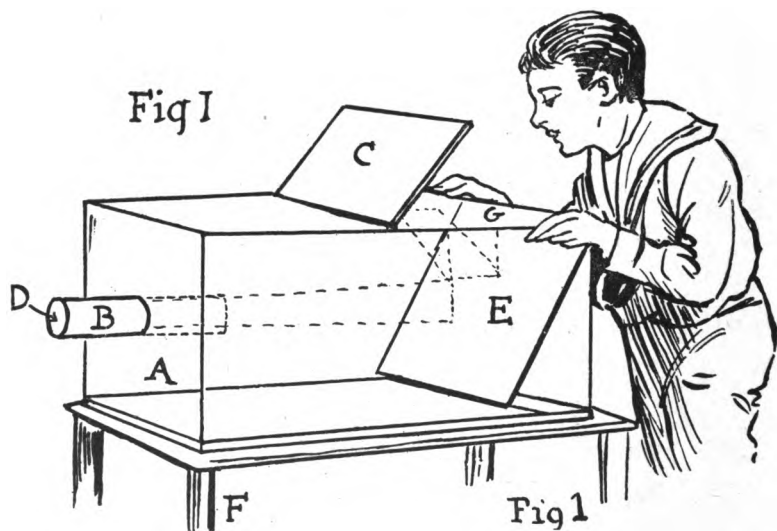

inside of the box and the tube should be painted black. The whole apparatus can be mounted on a table, *F*, or on a tripod. If you have a good photographic lens, it can be used, but the box will have to be smaller in proportion.

A modification of this is shown in Figure 2. Here

the lens, *D*, is mounted within a tube, *B*, bent at right angles and fixed in the roof of a room or the top of a box, *A*, large enough to hold the observer. Have a tinsmith make this tube for you. The rise above the

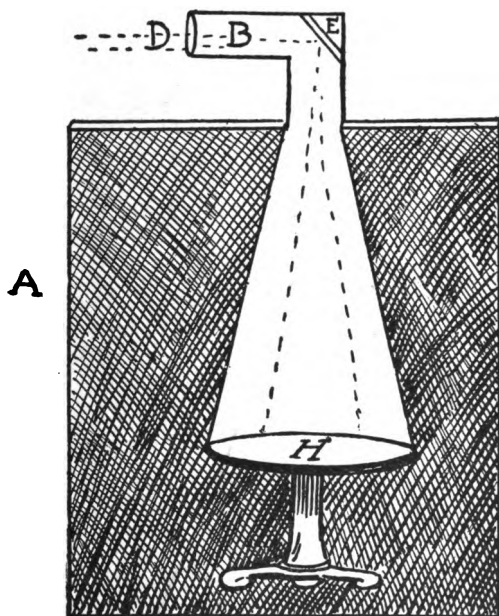

Fig 2

roof or top of the box should be nine inches, the right-angled piece twelve inches long, and the two pieces should be soldered together. There must be a second tube sliding into the outer one, *B*, by which to focus

the lens, *D*. A mirror is placed at an angle of  $45^\circ$  at the joint, *E*, of the tube.

Make a circular hole in your roof, and insert the tube. The room must be draped or painted black. A table, *H*, placed directly below the tube opening and covered with a white paper, will serve to catch the reflection and show the picture. Anything happening outside of the room and before the lens, like people walking, etc., will be faithfully reproduced in miniature on the table. This is a very amusing device and is not difficult to make. Of course, it will take experimenting to get the proper angles and distances. The periscope of a submarine makes use of the same principle of reflection.

## A SIMPLE DRAWING APPARATUS

THIS is a comparatively new device to teach young folks the rudiments of drawing, and is much better than tracing, as it is less mechanical and allows considerable scope in shading and adding free-hand details. It makes use of the reflective power of glass. The apparatus is easy to make and gives unalloyed pleasure.

Get a pane of glass of any size that may come to hand. An old window pane or a piece of glass from an old picture frame will answer. In case you have a piece cut to order, seven inches square, or seven by nine inches, will be a handy size. Take a piece of board, *A B C D*, a half of an inch thick and about nine by twelve inches, for a base. Sandpaper it thoroughly, as it must offer a smooth surface. Measure to find the exact middle line of the board halfway the length. Now cut two sticks one inch square and eight inches long, *E E* and *F F*. Groove one side of each with a

straight alley, a quarter of an inch deep and wide enough so that the glass will slide easily within it. Attach these uprights to the base at each end of the middle line, with the grooves facing, by means of thin nails and glue, so that they will remain rigid. Now

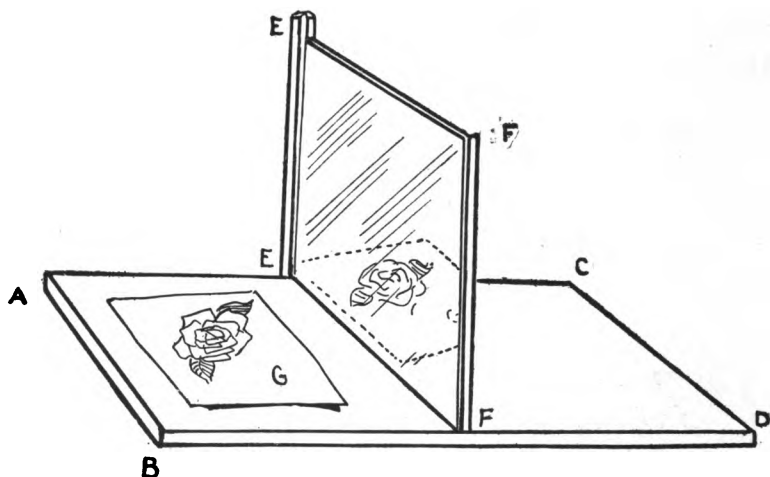

slide your glass into the grooves so that it stands upright on the base.

Take the picture that is to be copied and place it on the left-hand side, *G*, of the glass, using pins or push-tacks to keep it in place. If you look at the glass from the left, you will see a reflection, which will appear as if there were a duplicate of the picture on the right-

hand side. With your pencil in your right hand you can trace the outlines of the reflection, and the results will be a satisfactory picture. You can put in the details and the shading to suit yourself. Instead of nailing the uprights you can cut square holes in but not through the base and insert the uprights. This will enable you to remove them in case you want to pack the apparatus away.

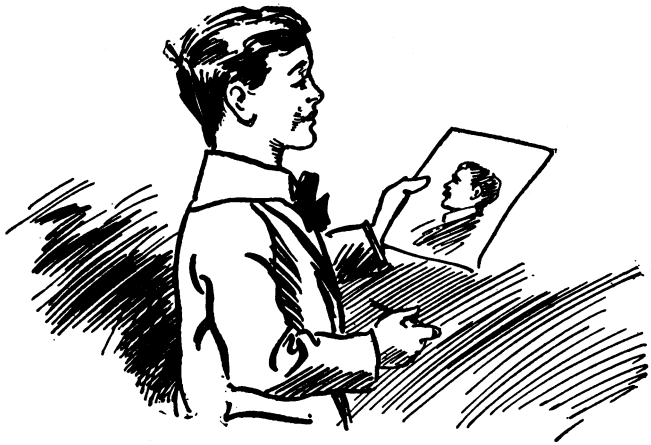



## A PENCIL-SHARPENER

THERE is no more untidy or disagreeable work than that of sharpening lead pencils for school use. A sharp knife is not always at hand, and at best the sharper the knife is, the greater is the danger of cutting one's self. The shavings are hard to keep off the floor, and the plumbago or lead dust has a nasty habit of soiling the fingers. Hence, the necessity of having a pencil-sharpener.

Those sold at the stationery stores are usually expensive, the very cheap ones being impracticable and useless.

Here is a useful little instrument, which you can easily make and which will serve to sharpen both lead and slate pencils.

Cut a round disk of wood, *A*, from four to six inches in diameter. The end of a big spool on which braid or tape is wound will answer. To the center of this glue a circular piece of wood, *B*, about one inch in

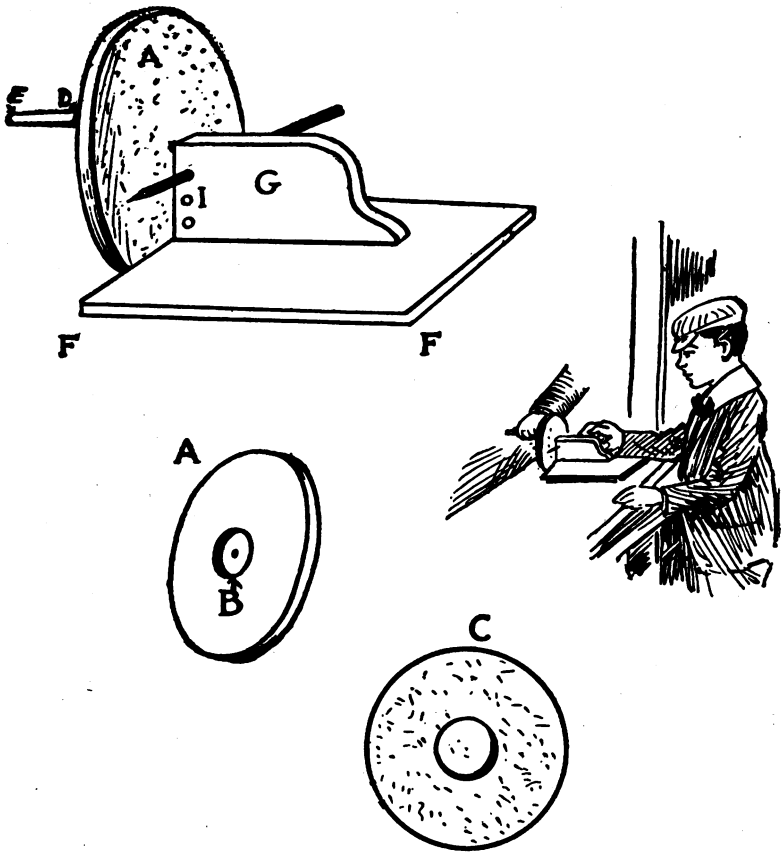

diameter, or a leather washer not over a quarter of an inch thick will answer. The object of this is to keep the big disk from touching the upright support. Cut out a circle of strong emery or sandpaper, *C*, with a hole in the center just large enough to fit over the

washer, *B*. The circle must be two inches larger in diameter than the disk, *A*. The edges of the sandpaper should be folded back over the disk and tacked to the other side. Make a small hole in the other side of the disk, at *D*, and into this insert a handle, *E*, to turn the wheel. A piece of old lead pencil will answer.

Next comes the support, *F F*. This consists of a firm base about eight inches square, attached to the middle of which is an upright, *G*, five inches long and three to four inches high. It must be one and one-half inches thick. Glue or nail these two pieces together, as shown in the cut. A long, thin screw, going through the center of the disk, can be attached to the upright, *G*, so that the disk will turn readily on this as its axis.

A series of two or more holes, *I*, must be bored into the upright, each at a different angle and just big enough to slip a pencil through readily. These act as supports for the pencil and hold it to the sandpaper at the proper angle. By turning the wheel rapidly and holding the pencil firmly against the sandpaper, you can get an excellent point in a very short time. A sheet of newspaper can be put under the base to catch the dust. The emery paper can be changed whenever necessary by taking off the wheel, removing the old paper, and tacking on a sheet of new paper.

## TOBOGGANS

IN some parts of America—for instance, in Canada—tobogganing is the recognized winter sport, and artfully constructed slides are in constant use all winter. A well-made toboggan is expensive, but a clever boy can make one that will do excellent service.

A toboggan should be about eight feet long and twenty inches wide. The best wood for the purpose is hickory. The hickory boards should be a quarter of an inch thick, and should be held together by battens of oak two inches wide and half an inch or more in thickness. Fasten these battens, *A A*, *B B*, and *C C*, across the boards with good brass screws, as shown in the illustration. At the extreme front end attach a similar batten, *D D*, which is several inches longer than the width of the sled, so that it will extend over the sides. The boards should be steamed, so that the front will bend up and over and remain in that position when cold. To hold them it is necessary to make a notch in

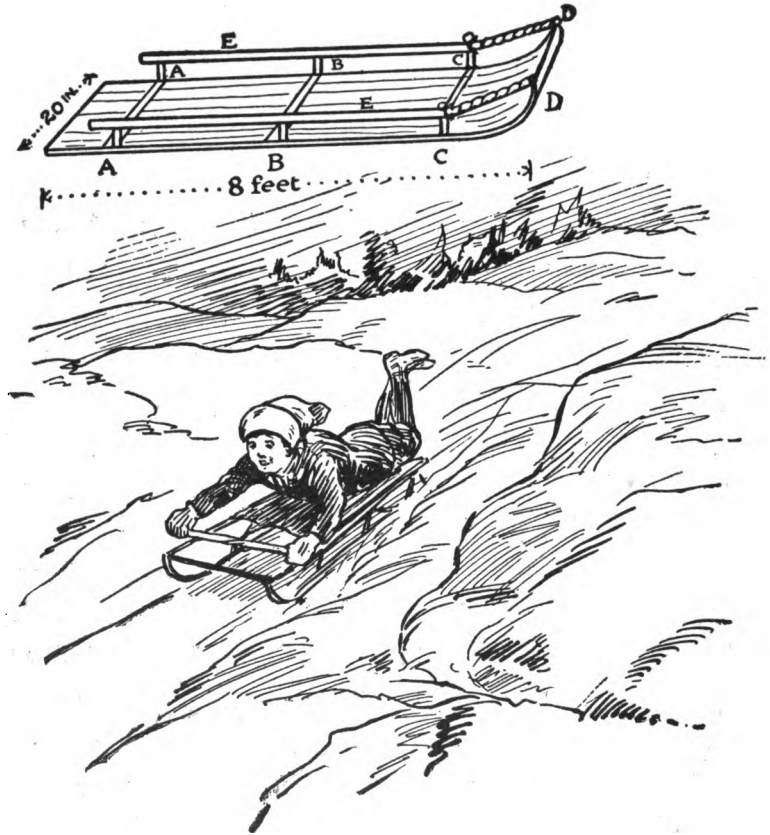

TOBOGGANS

each end of the projecting front batten, tie a strong rope around the batten and within these notches, and fasten the rope onto the next batten by means of strong screw-eyes.

Cut a long curtain-pole of oak or hickory to form the rails, *E E*. These must be almost as long as the toboggan. They are not fastened directly onto the battens, but must be raised about two inches above them by means of wooden blocks, so as to furnish a firm grip to the hands. These rails must be securely fastened, through the blocks, to the bottom boards by iron bolts and nuts. The speed acquired in going downhill is often very great, and nothing should be left undone to insure safety. The wood should be nicely sandpapered and varnished.

## A ROCKABY COASTER

A SLED that will serve also as a rocking-horse may seem a novelty, but it has been in use for many years in England. It is easily made as follows:

Get two pieces of hard wood, *A*, three feet long, six inches wide, and half an inch thick. Cut these with a curve so that the ends will taper to a point. Cut grooves or laps at intervals along the top, about three inches long and half an inch wide, and into these fasten the cross-braces, *B, B, B*, to hold the sides together firmly. The width between the sides should be eighteen inches. The top can be made of a solid board of the proper length and width; or, if this is hard to get, make several connecting pieces eighteen inches long and the proper width, nail them into place, and on these as a base nail matched boards of the proper length.

Get a long curtain pole of oak and cut it into two lengths of three feet each, *C C*. These will serve as

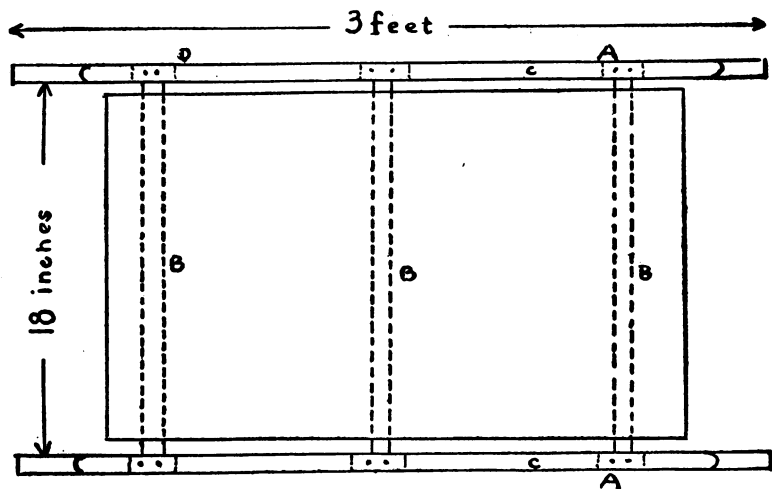
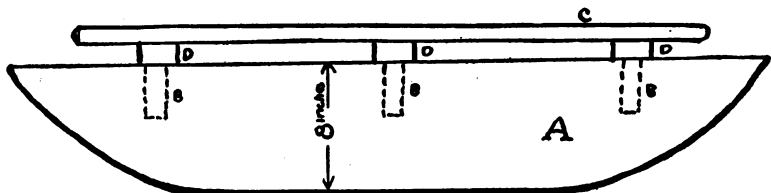

A ROCKABY COASTER



handrails for the sides. They should be attached by means of screw bolts, through square blocks of wood, *D*, three inches high, and placed at intervals of a foot. The hand will thus be able to grip the rods and hold fast.

The bottom of the rocker sides should be grooved the entire length and an iron strip fastened into the groove as a runner, one on each side. A blacksmith will attend to this at little expense. To steer this coaster down a moderately high hill, it is best to lie on it flat with the feet at the rear, and by digging the right or left foot into the ground the sled can be made to turn in the opposite direction. A longer sled for holding several boys at a time will be found practical.

## A BOBSLED

A DOUBLE-RUNNER that will take the steepest hills with a load of six or more boys is something that will bring joy to the heart of every lad in those parts of the United States where there is snow. It will do more—it will bring the red tint of health to his cheeks and give him a ravenous appetite for the next meal. A good bobsled can be made of very inexpensive materials. Great care should be taken, however, to have all the parts strong and firm, as a sled of this size is subject to great strain in going down a steep hill, and you must avoid an accident at all hazards. Follow the directions carefully, and scrutinize every part to see that there is no inherent weakness, before risking your body on it.

Take two sleds, *A* and *B*, and connect them by a long seat, *S*. The front sled should be twenty-five inches long and the rear sled about twenty. These dimensions can be varied according to the size you desire. Both

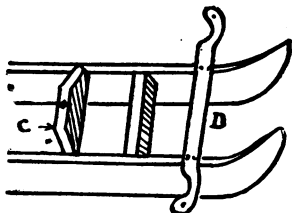
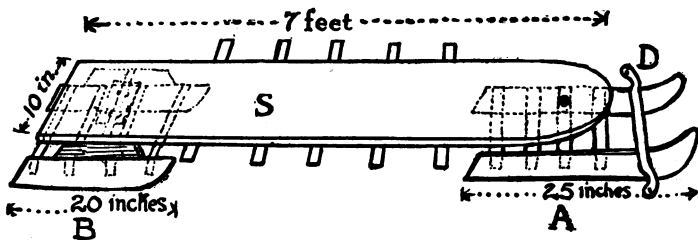
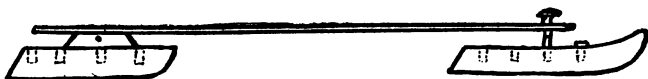

FRONT AXLE

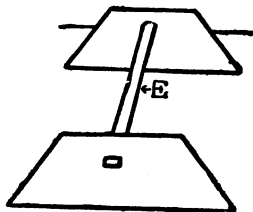
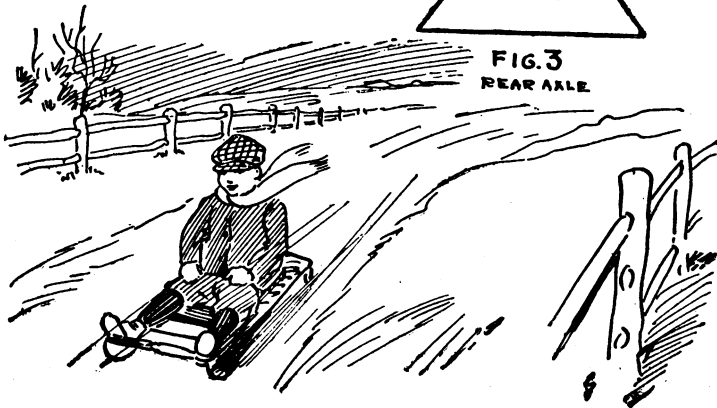

FIG. 3  
REAR AXLE



A BOBSLED

sleds should be of the same height and width. The side pieces are of hard wood an inch thick and four inches high, and are braced with hardwood crosspieces two inches wide and an inch or more thick. These crosspieces are either lapped over or set into the sides, and are nailed securely, while in addition brackets of iron are screwed to them and to the sides.

The second brace of the front sled is a strong block, *C* (Fig. 2), attached firmly to the sides. This must be of hard wood two inches thick and four inches high in the middle. A similar block is attached under the curved front end of the long seat. Holes are made through the center of both blocks and the long seat. Through these a long steel bolt is inserted and secured with iron washers and nuts. This is the axis on which the front sled is turned in steering. On the front of the sled is the steering bar, *D*. This is a stout piece of wood, two inches wide by an inch or more thick, and is securely fastened to the top of the runners and extends beyond them about six inches on each side of the sled. It has a curve carved out at each end as a foot-rest, and has two holes, one at either end, in which to fasten ropes for steering.

The rear sled is similar in construction to the front one, but is differently attached to the long seat. In

order to yield in going over bumps, it must have a lateral or up-and-down give. This is obtained by attaching to the middle of the top edge of the sides of the sled two blocks (Fig. 3) of inch-wide wood, about eight inches long at the lower ends, and of the right height to make the long board, *S*, level. The upper edge of the blocks should be about five inches, and the sides should slant away from each other. Below the long seat is attached a grooved block, into which this bolt fits and to which it is secured by strong staples, thus giving a hinge on which the sled can bob up and down.

The long seat may vary in length according to your requirements. It should be of strong lumber, about ten inches wide, and from an inch to an inch and a half thick. It can be upholstered with old cushions, or remain bare. A number of crosspieces should be screwed a foot apart to the under side, and should extend four inches out on either side, to serve as foot-rests for the passengers.

And now, All aboard! We're off to the land of snow!

## A SWIFT ICE BOAT

THERE is no more exhilarating sport than ice boating. Gliding over the smooth surface of a river on a cold day makes the flesh tingle and the blood course merrily through the veins.

An ice yacht is easily made and requires but little skill to maneuver. The framework consists of two crosspieces of strong plank two inches thick and six inches wide. One, *A B*, must be six feet long and the other, *C D*, eight feet long. Across the underside of each end of the shorter plank attach a block of oak a foot long and two inches wide, *E*, and to each of these blocks secure a skate in the same way as you would put it on the foot for skating.

The long plank, *C D*, must be securely bolted on the other at right angles, *N*, so that one end, *D*, extends twelve inches or more in front of the crosspiece. A piece of board about one foot wide, *F*, can be secured on both sides of the longer plank, to serve as a seat.

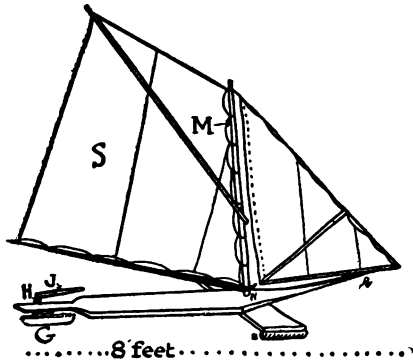
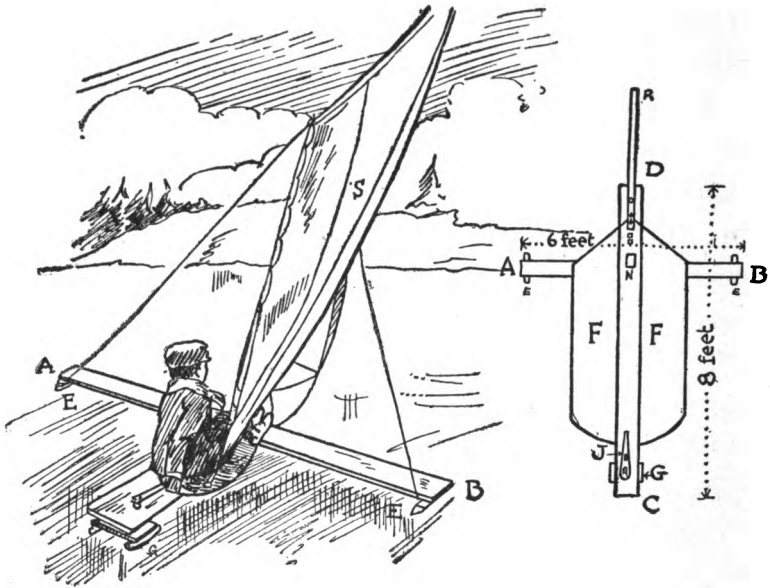

A SWIFT ICE BOAT

The rudder, *G*, consists of a board eight inches square, to which must be securely attached two skates set parallel to one another.

An upright, *H*, securely attached to this rudder board, must extend upward through a hole in the plank, and a tiller, *J*, be fixed to it, as shown, so that the rudder board may be swung from side to side. With this rudder the ice boat can be guided in any direction by the tiller.

For the mast, *M*, a straight spruce pole about six feet long, four inches at the bottom and tapering to two inches at the top, is needed. Square the bottom so that it fits tightly into a square opening right in the middle, *N*, where the two frame planks meet. It must be securely nailed or screwed. The bow point, *R*, must be made out of tough wood, four feet long, and two inches square at the end, tapering toward the point.

The arrangements of pulleys for the rigging is the same as in a toy boat, a model for which can easily be obtained. The sails, *S*, should be of strong unbleached cotton or duck, cut to the proper size and shape and with the seams strongly sewed. A thin manila rope should be sewed along the top and bottom edges. There must be holes or eyelets worked at intervals of four or five inches, to tie the sails to the mast or boom.



## A LAND BOAT

IT takes wealth to own a yacht that will steam from place to place on the water, and not every boy can aspire to possess one, but every clever boy who can handle a saw and hammer can make himself a yacht for land navigation. Endless fun can be had with one of these boats, and in a good breeze it will run ten miles or more an hour. In some States, like Florida and California, these land boats are used for pleasure and business not only by boys, but by men as well.

Get spruce planks for the body of the boat. They should be strong and free from knots. Two by four inches is the best thickness. The side supports, *A B* and *C B* (Fig. 1), should be cut twelve feet long and beveled to form a *V* at one end, *B*. One piece, *D E*, eight feet long, forms the crosspiece at the front, leaving ten inches of the long pieces projecting. These pieces should be strongly bolted together. Three feet back of this crosspiece, *D E*, another crosspiece, *F G*,

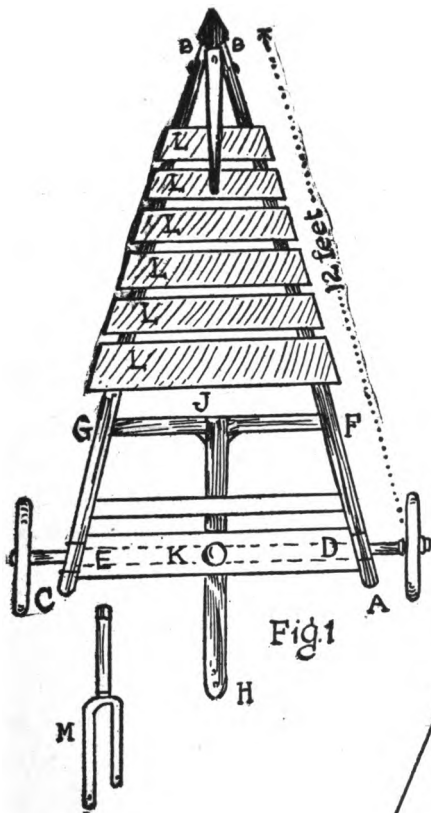

Fig 1

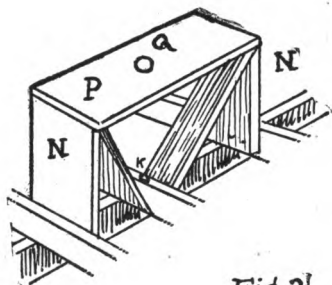

Fig 2

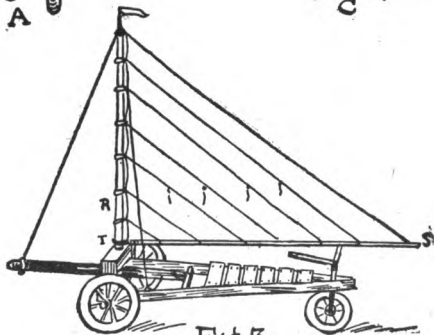

Fig 3

A LAND BOAT

is secured, to brace the frame. In the center of the front of this, a hole, *J*, about one inch square, is cut, to hold the tenon on the end of the bowsprit, *J H*. This bowsprit must be seven feet long. The end, *J*, fits into the brace, as already described, and must be secured by two iron right-angled pieces so as to make it immovable. The bowsprit is bolted on to the first cross-piece, *D E*, at *K*. Cross-boards, *L L*, cut to the right size for seats, are nailed to the V-shaped frame.

For the wheels it is best to get those of an old baby-carriage or velocipede. Cut the axle in halves and secure a half, the wheel projecting, under each end of the front crosspiece, with clamps or screws, so that it will not shift. The rear wheel is used as a rudder and must be made so as to turn to the right or left. Have a blacksmith make an iron fork with a stem, as at *M*. The stem should be passed through a hole in the timbers where they meet at the V-point, *B*. A tiller can be made of strong wood and fitted securely over the top of the rudder stem. The handle of this tiller should be of a size convenient to the hand and bound with cord, so that the hand will not slip.

Now for the mast, the motor power that makes the boat go. The mast support is attached to the first cross-timber, at *K*. The uprights, *N N* (Fig. 2), are

two boards, eight inches wide and twenty inches long. These must be attached to the outer framework with screws. Across the tops of these two boards screw another board, *P*, of just the right width, like a bench. In this top board bore a hole, *Q*, three inches in diameter, through which to stick the mast.

The mast, *R* (Fig. 3), is made of a pole fourteen or fifteen feet long, free from knots or flaws. A slender spruce tree will answer. It should be stripped of its bark and the upper end tapered. The bottom, or wider end, fits into the hole at *Q* and is fastened securely to *DE* at *K*. The boom for the mast, *S*, should be sixteen feet long. Around the mast end of this boom fix two semicircles, *T*, of iron or wood, that will clasp the mast and move freely about it.

The sail should be made of sailcloth or heavy unbleached muslin. The seams can be sewed by hand or on a machine. It must measure ten feet on the mast, fifteen on the boom, and eighteen on the diagonal. It should be bound with stout ropes and have large iron or wooden rings to hold it to the mast, so that they can slip up and down. At the masthead there should be a pulley with the ropes so arranged that the mast can be raised or lowered at will. If the wheels have rubber tires, the boat will go smoother.

## A CAGE FOR MICE

MICE are easily trained and their antics will serve to pass many a pleasant hour. White mice can be bought at a low price and are delightful pets; but the common gray mouse is easily caught alive in a wire trap and in a few days can be taught to do very amusing circus stunts, such as spinning on a merry-go-round wheel, working a treadmill, climbing a ladder, etc. A cage of trained mice makes an attractive window display for a store, and is sure to gather a big crowd.

The cage is made as follows: Get a stout wooden box eighteen inches long, twelve inches high, and ten or twelve inches deep. Remove the front, *C, D, E, F*. Line the floor, *A, B, C, F*, with tin, which must be turned up two inches on the back and sides. This is to prevent the mice from gnawing their way out through the wood. On one side, say, at *G*, put a little box with cotton for the mice to sleep in. The front of the box, *C, D, E, F*, is to be covered with thin wire

netting with a mesh one-quarter of an inch square. This will enable you to see through. A plate of glass will also answer, in which case you must have a wire-screened opening at one side for ventilation. A door with hinges and a bolt must be made at one end, as at *H*.

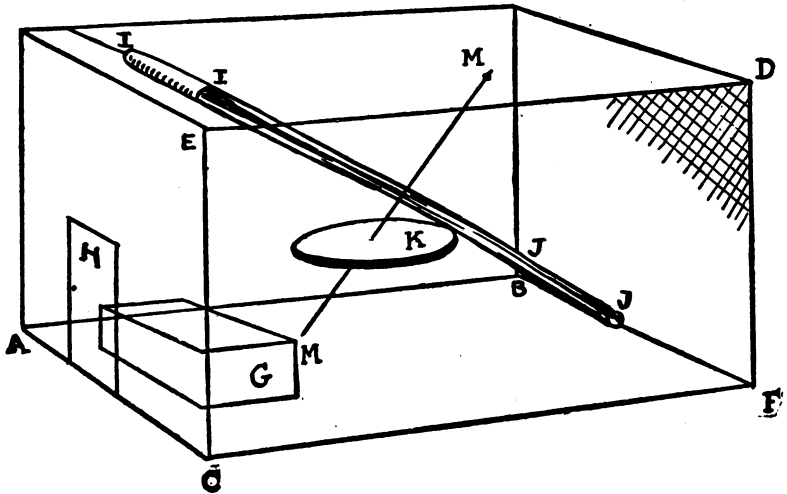

In the cage a number of acrobatic devices can be arranged. A merry-go-round consists of a disk of thin wood five or six inches in diameter, *K*, with a firm shaft or axle at an angle of about 50° and long enough to reach from top to bottom of the cage. This shaft fits into holes at top and bottom, *M*, *M*, and must turn easily. The mice soon learn to get on the disk, which

must be near the ground, and make it revolve by running around its circumference. Sometimes they slide off, but they seem to enjoy it.

A treadmill is made by sewing a piece of cotton duck, two and one-half inches wide and of the proper length, into an endless belt like a roller towel. This must go over two spools or spindles, *I I* and *J J*, at an angle of about  $45^\circ$  with the floor, the other diagonally across the cage from it and near the top. The spools are suspended from the top of the cage on axles of bent wire, and must turn easily. The mice will try to move upward and so cause the duck belt to slide back. A great speed can be attained if the spools or spindles slide easily. Often two mice will ride this treadmill side by side and race at full speed, each trying to outdo the other. A wire wheel such as is used in squarrel cages may be attached to one side of the box also.



## TRAPS FOR ANIMALS

The following is an easily made trap that gives excellent results: Make a trough of pine boards, *A, B, C, D, E, F* (Fig. 1), two feet long, eight inches high, and nine inches wide, without ends. The boards must be neatly nailed together. Across the top midway the length of the box, from the point *K*, nail a strip of wood four inches wide and nine inches long. This will form a support for the doors. In the center of this bore a hole and in the bottom of the box a similar hole directly under the first. Get a round stick fifteen inches long, *GH* (Fig. 2), and stand it upright in these two holes. It will protrude about six inches above the top. Now make your two doors, each of which is in two parts, which are rigidly fastened together at right angles. The doors are just long enough to fit easily between the upper and side edges of the trough. The part of each door which is hinged to the crosspiece, one end of which is *K*, is ten inches wide, the lower part, or end



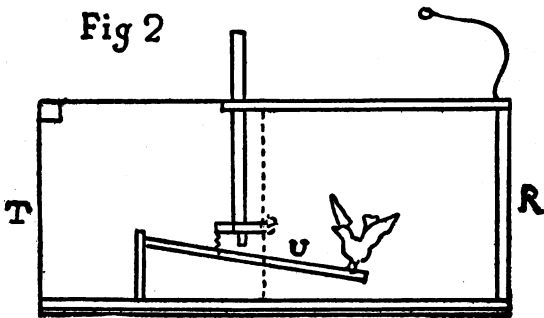
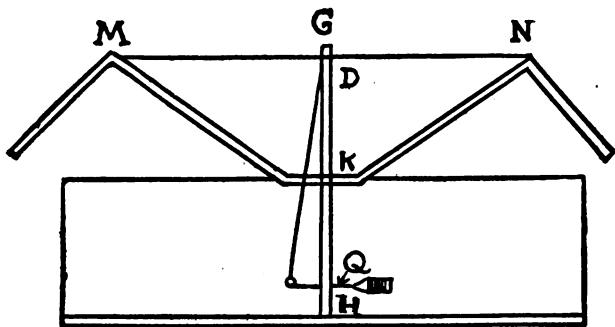
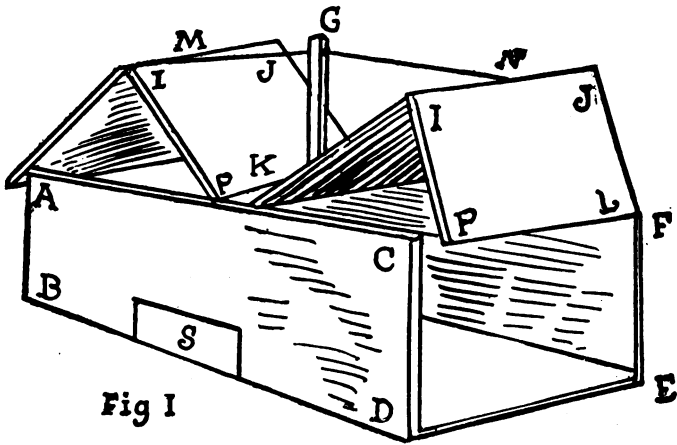

Fig 3

TRAPS FOR ANIMALS

flap, being just large enough to cover the end opening of the trough, that is, about eight inches.

In the upright stick half an inch from the top, *G*, insert a small screw-eye into which a string can easily slide. In the lower end of the stick three inches from the bottom bore a hole one-quarter of an inch in diameter and insert a piece of wire, *Q*, about four inches long. One end of this must firmly hold the bait—a piece of corn or a nut. Tie a short string to the center, *M* and *N*, of the jointed edge of each door. Let the ends come through the screw-eye, at *G*, and descend into the box through a small hole in the crosspiece at *K*. The ends are then tied to a small brass ring. This ring is pulled down so that the doors are opened, and the ring is slipped onto the extreme edge of the wire, *Q*, so that the least pull on the wire will make the ring slide off and the weight of the doors will cause them to close and thus imprison the animals. A peephole in the side, *S* (Fig. 1), closed by a sliding piece of glass.

A similar trap for birds (Fig. 3) has only one door, *R*, the end of the box, *I*, being solid. The cord that holds the door open must be attached to a delicate trigger, which is at the end of a mast or support, *U*, on which birdseed or other bait is glued. The moment the bird alights on this roost, the trigger is sprung and the door closes.

## A PIGEON HOUSE

**THERE** is no more interesting pastime than that of raising pigeons, and it is profitable, too, if understood and properly attended to.

To supply the birds with a house is one of the first duties of the breeder. Usually a high roof is selected, or a pole may be securely erected in the yard. On this the pigeon house must be placed. It must be out of reach of rats and cats, and must always face a warm quarter, as cold winds are destructive to young pigeons. The box may have any convenient form, although that of an equilateral triangle is best, as the sloping roof allows the rain to flow off. The house should be made of one-inch pine boards, and should be eight inches deep, with each division or story about eight inches high.

The openings, or doors, should be about six inches high to give the pigeons ample room to enter and turn around. Each opening admits into a separate room,

which is divided from the next by a thin partition. It is advisable to have an opening between every two rooms, so that mates can communicate with each other and yet be separated. On each story and before each

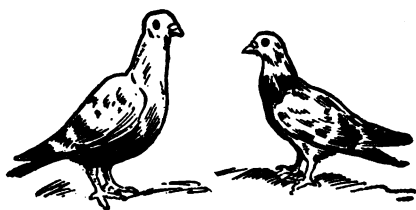
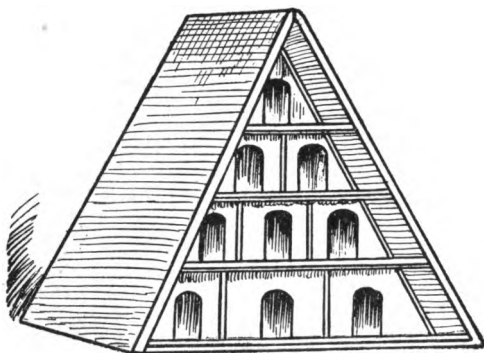

set of holes there should be a shelf, running the entire length of the story but divided by vertical partitions. This is for the birds to rest on. A house like this will be attractive to the birds. It can be painted in plain or contrasting colors.

## PRETTY DOVECOTES

AN ornament to the garden and a comfortable resting-place for doves and pigeons is made as follows:

Secure a tongue-and-groove box from two and a half to three feet in each direction. Remove the top and bottom, leaving only the four sides, *A, B, C, D, C, D, E, F*, etc. (Fig. 1). Nail on the inside cleats for three shelves equally distant from each other, two cleats for every shelf. Make the shelves, *H H*, of half-inch boards just large enough to fit easily into the box and rest on the cleats, so that you can take them out to clean them.

Nail to the under side of each shelf two partitions of half-inch wood, to extend all the way across. These will divide every shelf into three equal parts. The partitions of two shelves should go the same way of the box but those of the third the opposite way. When you have put in the shelves, cut out doors or openings, *M*, in the sides. Measure the spaces for the doors in

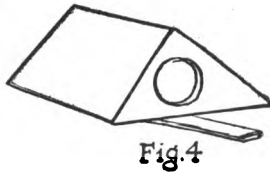
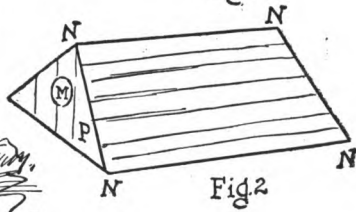
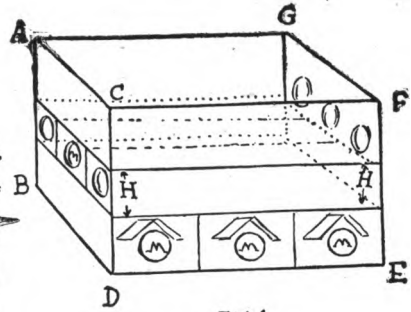
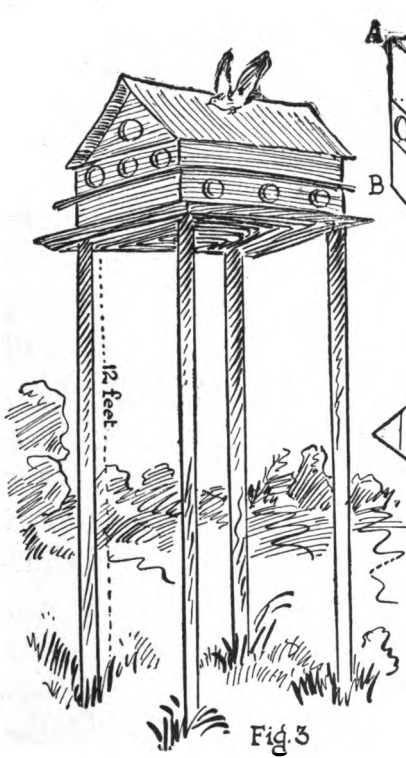

PRETTY DOVE COTES

such a way that one opening will come in the middle of each division and open into it exclusively. There will thus be three openings in a row on every one of three sides of the cote, some low to correspond with the lower shelf, others high to open onto the higher shelves. A little forethought will be necessary to do this accurately.

For the roof (Fig. 2) take two half-inch boards, either solid or matched and grooved, and cut them two inches longer than the width of the box,—so that the roof will hang over one inch on each end *NN*,—and wide enough to form a sloped peak one and a half feet from the top. Fasten the two sides of the roof firmly together at the proper angle with screws. Close the ends of the roof with grooved boards, *P*, with a round opening in each, *M*, for a door. This roof should be attached to the body of the cote in such a way that it is secure against the wind, but can be lifted off in order to clean the interior.

Four spruce poles, about twelve feet high, with the bark left on, will serve as a support (Fig. 3). These must be firmly embedded in the ground three feet apart, to form a square. Across the level tops of these poles nail a shelf about four feet square, of solid board or matched boards. This will form a platform for the

house. It should have heavy cleats on all four sides, placed just right to hold the cote securely. These should have one-quarter-inch holes at intervals through which to slip nails or bolts into similarly placed holes in the lower edge of the cote. The cote will then be held securely.

Fancy cornices or eaves (Fig. 4) can be applied over the windows to make them more ornamental, and the board work can be covered with bark to make it look rustic. Roosts can also be nailed outside of each window. This cote can be placed on the roof of a barn or house, if so desired, providing the position is accessible. It should be put where there is lots of sun.



## A SENSIBLE DOG KENNEL

TOWSER should have a comfortable kennel, for he is a faithful dog and deserves the joys to be derived from "Home, sweet home." Get a dry-goods box, big enough to make a comfortable den for our four-footed friend, and in the front end cut an opening, *A*, large enough for him to get in and out easily. This should be semi-circular in shape at the top, and the sides should be perpendicular to the floor.

On both sides near the top nail securely three or four blocks of wood about two inches square and three inches long, as shown at *B*. Upon these, cross the entire length of the side, nail a strip of wood, *C C*, two inches wide and as long as the side of the box. This strip will serve as a support for the roof; and the blocks, separating it from the sides of the box, will allow air to enter under the roof and give thorough ventilation.

Next, get some half-inch, matched pine boards with which to make two triangular gables. Nail one on each

end of the box, the boards running up and down, as *D*. Run a three-inch strip of wood, *E*, from apex to apex, first cutting out at the ends enough to allow the strip to

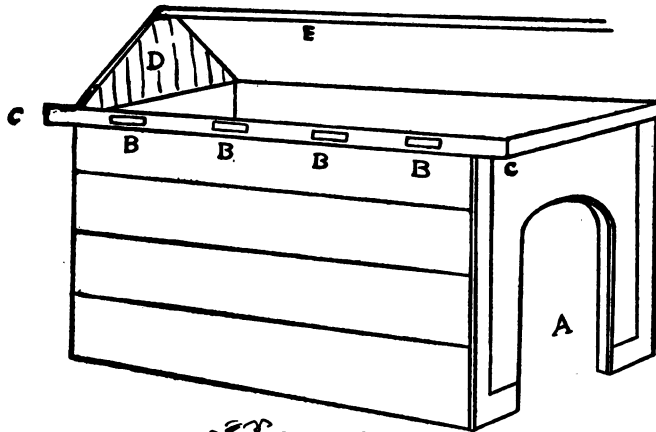

fit tightly. This strip forms the ridge of the roof. Now use more of your matched boarding to form two halves of the roof proper. These should be big enough to extend three inches beyond the ends and three inches

beyond the strips, *C C*, at the sides. Reënforce them with two or more strips in order to hold the boards together. Hinge each half of the roof by two strong hinges to the ridge strip, *E*, so that the roof can be opened up for the purpose of cleaning out the kennel. This will make a sanitary and comfortable house of which any dog might well be proud.

A similar arrangement will be found useful in breeding bantam chickens. The opening in front must be closed by a little grated gate. A number of roosts should be nailed between the side walls, and several boxes containing hay for nests should be fastened to the sides. Sand or cork on the bottom of the box will be appreciated by the feathered inhabitants.

## PROTECTION FOR BIRDS

THE Audubon Society is doing much for the protection of birds, and boys ought to endeavor to second its efforts by showing kindness and consideration for all kinds of feathered creatures. In times of storm birds seek a shelter, under a tree or the eaves of a barn or porch, where they are protected from the elements. Make an inviting shelter for them, and they will repay you many times over by becoming accustomed to your place and freeing it from objectionable insects. A shelter can be made from sticks and boards with very little labor, the form corresponding to the wishes of the young mechanic. The following is a simple suggestion easily carried out:

Get two uprights, *A A*, three-inch-square planks, or, better still, two spruce poles with the bark still on. Plant these firmly in the ground, three feet apart, with about two feet below the surface and about seven feet above. To the sides attach four Y-



PROTECTION FOR BIRDS

braces, *B*, of half-inch board, two inches wide and twelve to eighteen inches long, as supports for the roof. For crosspieces, *C*, take narrow laths or, better still, half-inch dowels, which can easily be obtained. Bore holes of the proper diameter in the Y-braces, as in the illustration. The dowels must be an inch longer than the distance between the poles. Insert these in the holes and glue them fast.

For the roof take matched and grooved boards and make two solid sections about three feet, six inches in length, and about four feet wide, or sufficiently wide to shelter the Y-braces thoroughly. Bevel them at the edge so that they will meet in a peak, *D*, and screw these edges together. Mount this roof firmly on the top of the poles and braces, and the shelter is complete. The crosspieces or dowels serve as roosts for the birds as well as for additional strength.

A bench, *E*, can be made between the lower part of the poles to be used in pleasant weather as a sheltered seat. A long board, about nine inches wide, can be attached to the uprights with a supporting block of wood, *F*, in the center to prevent sagging, and a narrow plank, *G*, along the back as a support for the shoulders. Covering the entire shelter with bark adds to its beauty.

## HOUSES FOR GUINEA PIGS AND RABBITS

THE keeping of pets is not only enjoyable but instructive as well, as it keeps a boy in touch with nature, teaches him the rudiments of natural history, and places him in sympathy with the dumb friends with which God has provided us. Rabbits and guinea pigs are especial favorites with boys and repay any attention bestowed upon them. They should be carefully housed and made comfortable.

It is easy to prepare a house for these pets. About a third of the shelter should be dark, as the little animals like seclusion at times. The illustrations show two kinds of houses that can be fashioned out of shoe or dry-goods boxes, with a little effort. Legs as high as may be required can be nailed to the sides of the box. Part of the front is sawed out, and with the wood thus obtained, the other part can be enclosed, making a compartment into which the animal can retire. A square or circular hole in this partition allows passage into the

closed compartment. The open front can now be covered with a wire netting. The lid, *A*, of the box should be hinged so that it can be opened for the purpose of cleaning out the house or getting at the rabbit.

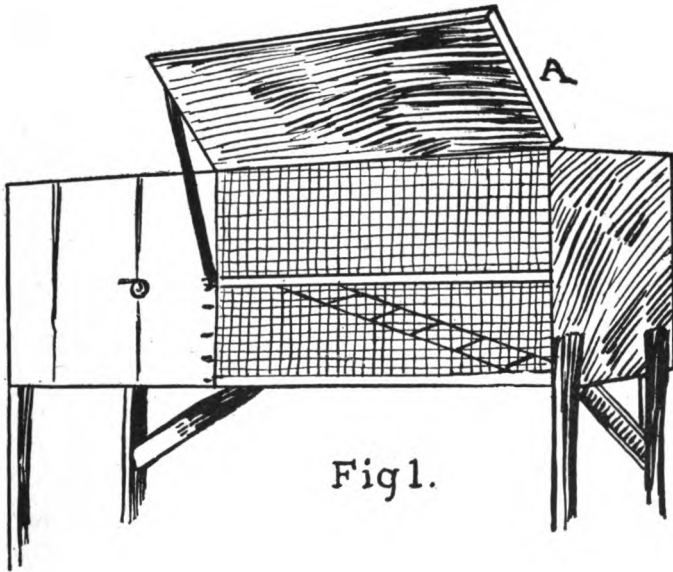

Fig 1.

An inclined runway, a horizontal roost, and other devices can be introduced into the open part for the animal to exercise on. If the box is used for a squirrel cage, a round cylinder or wire can be placed at one end, so arranged on an axis that it will easily revolve when the squirrel gets inside. The closed compartment



should have several one-inch holes bored near the top so that it may have perfect ventilation, for pure air is as necessary to animals as it is to human beings. Similar houses or hutches can be made for pet monkeys, opossums, foxes, and other animals. A padlock to fasten the lid is of importance, as it will prevent the animal from escaping or from being stolen.

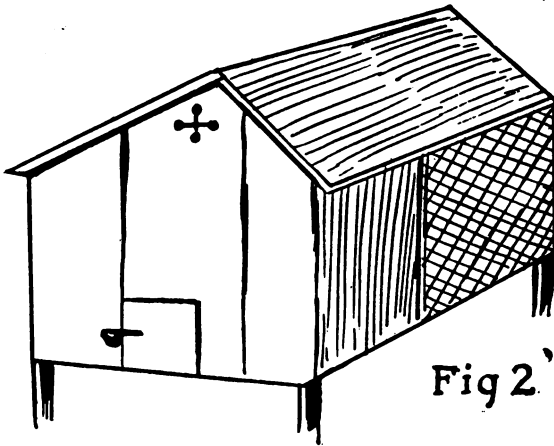

Fig 2'

## CHICKEN COOPS

WHAT boy does not like spring chickens? They are good to look at as well as delicious to eat, but the young chicks need care or they will never grow large enough to deck the table. When the chicks begin to pick and scrape for their meals, the old hen should be kept in confinement, or there will be little left of the garden. Yet she must have easy access to her little ones. Here are two simple yet effective coops that will serve their purpose admirably.

Figure 1 shows a coop made out of two boards joined together, end to end at right angles, to form a peaked roof. At the bottom their spread should be twenty-four inches across, and from the ground to the peak the distance should be about twenty inches. The width of the boards, *A* to *B*, is two feet. The base on which this roof rests is made by taking three pieces of wood, each six inches high and about two feet long, *F, G, H, I* (Fig. 3). Nail these to form three sides of a square,

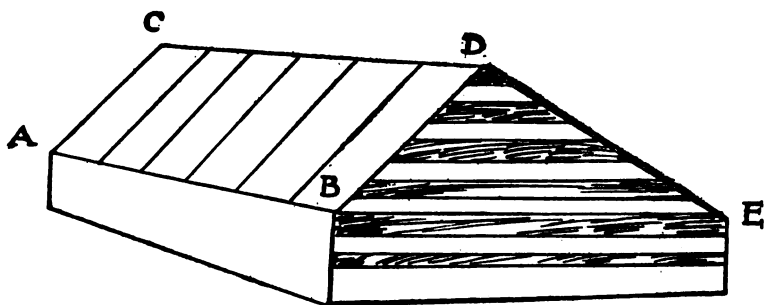

Fig. 1

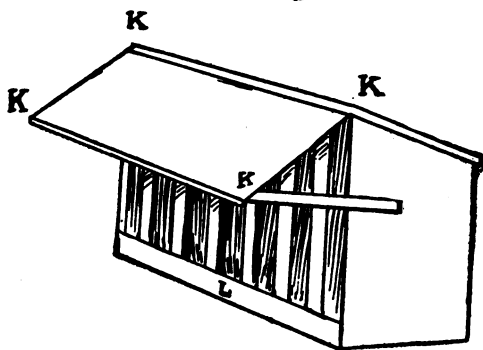

Fig 2

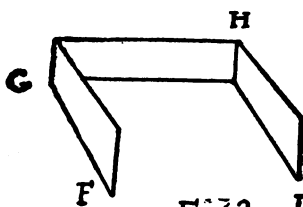

Fig 3

and place the roof over it, nailing it to the sides securely. A number of slats or laths of the required length should be nailed across the front. These should not be too close together to prevent the little ones from coming and going to their mother. The old hen is placed in the coop by simply putting the coop over her, as she stands on the ground.

A more elaborate coop is made by setting a shoe box or a big soap box up on one side, nailing a three-inch wide strip, *L*, along the ground edge, and to it and the upper edge attaching two-inch-wide strips two inches apart. A thin board, *K K*, can be nailed across the front like an awning to keep the sun off the brood. You might raise the box an inch from the ground by placing little blocks under the corners, and then bore a few holes in the bottom to drain off moisture. The strips forming the front can be arranged on a frame and hinged, so that easy access can be had to the interior in order to clean it out or to get at the hen. The upper side or roof can be made to slant as a protection against rain. Painting the coops will add greatly to their appearance, and keep them from rotting.

## A PRACTICAL WATER WHEEL

IF YOU live or camp near a small stream, one that tumbles over the stones in a series of cascades, you can derive both pleasure and instruction by utilizing the water power to propel machinery. Many an eminent engineer learned the beginnings of his art with just such an improvised appliance.

First get a strong wooden box (Fig. 2), about as high as the water is deep. Take out one end, *A, B, C, D*, and cut away the upper third of the opposite end, the edge of which is *EF*. Make a shelf, *H*, to rest on the upper edge of this farther end, and to extend halfway across the box. This will serve to dam the stream and support the wheel.

The wheel is made as follows: Take six strips of two-inch-wide wood, in length two thirds the height of the box, that is, as long as the distance between the bottom and the shelf, *H*. Nail them together in two pairs of three each, crossing them at the center at equal

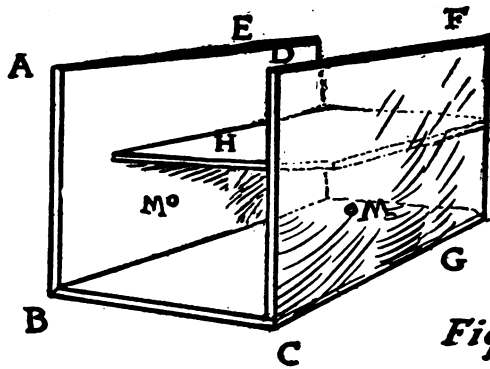

Fig 2.

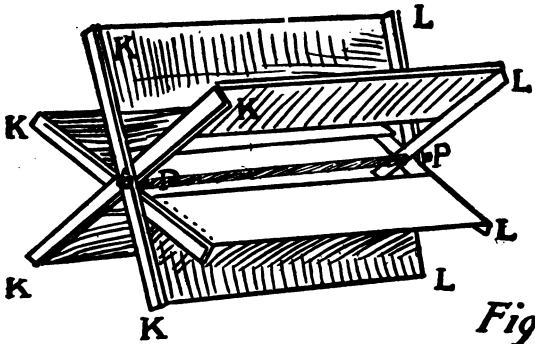

Fig 1

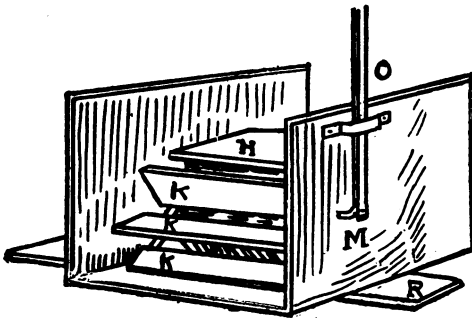

Fig 3

A PRACTICAL WATER WHEEL

angles, so that they stick out like the spokes of a wheel. They should be nailed securely in this position, but so that a square hole may be made through them at the centers,  $P$ , and  $P'$  (Fig. 2), through which the shaft is to go. The shaft may be made of a hard piece of wood, in length about three inches more than the width of the box, and with the ends rounded for about one and one half inches, or so that the square part extends from the center almost to the sides of the box.

Slip the two sets of crosspieces one onto each end of the shaft just beyond the rounded ends, and fasten them securely, having the crosspieces project in lines parallel to each other. Unite corresponding ends of the crosspieces with paddles of quarter-inch board, which are sufficiently long to fit loosely into the box between the sides. The paddles are of a width one half the distance from the outer end of each crosspiece to the shaft, which is the axis of the wheel thus made. In the center of each side of the box a rounded hole,  $M$  (Fig. 3), must be made, through which the ends of the shaft are to go. A crank must be attached to one of these ends, so that it can work an upright piston,  $O$ , and in turn can be geared to any kind of light machine, such as a small dynamo, scroll saw, or the like.

The paddle wheel must be arranged in the box so

that the water flowing over the shelf, *H*, will fall upon the paddles, *K K*, etc., and cause them to sink, thereby making the wheel revolve. The box should be nailed to a stout board, *R*, and this should be weighted by stones to prevent the box from being carried away. A dam of sticks, stone, and clay should be built on each side of the box to raise the level of the water. A little practise is needed to get the best results. This wheel is on the same principle that the old-fashioned water mill was constructed. This is known as an "overshot" wheel. Where the flowing water engages the paddles from below, forcing them forward, it is called an "undershot" wheel.



## AN UNDERSHOT WATER WHEEL

THE hubs and spokes of two old wagon wheels, *A A*, can be made into a very effective water wheel if arranged as follows:

Cut out all the iron bands in the hub and cut a square hole, *B* (Fig. 2), where the round hole was originally. Make a square axle, *D*, of strong wood, that will just fit into these square holes in the hubs, say, about one and a half inches or more square, and at least forty inches long. The ends of the axle can be rounded to fit into bearings, *G G* (Fig. 1). Fit the hubs on the square ends of the axle, about thirty inches apart, with the spokes parallel to each other, and fasten them securely. The paddles, *E, E*, etc., should be about thirty-five inches in length, ten inches wide, and made of strong boards. Attach one paddle to each pair of spokes with iron bolts and nuts. It is best to chisel one side of each spoke flat instead of round, as in *F* (Fig. 3), so that the paddle will be firmer.

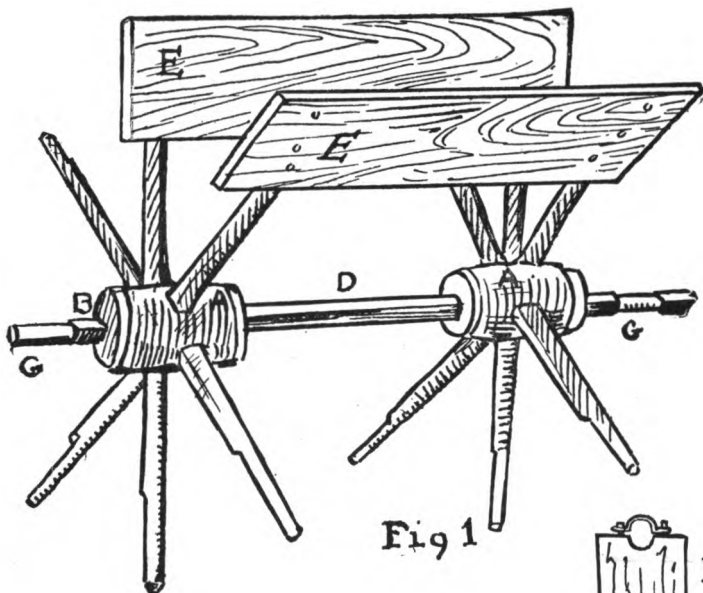

Fig 1



Fig 3

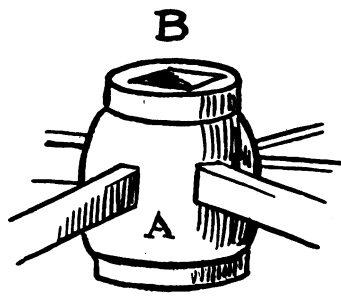

Fig. 2

AN UNDERSHOT WATER WHEEL

The bearing, to hold the axle can be made of a square block of wood, *H*, with a semicircular notch, the size of the rounded axle, cut out. An iron clamp curved in the shape of a semicircle can be screwed down over this, or a second block of wood, notched out as the first can be used instead. A similar bearing must be made for the other end. If the wheel is to be used to give power, one end of the axle can be extended as far as may be necessary and a pulley wheel attached to it.

A water wheel like this can be used as an undershot wheel, and should be put up in a narrow part of a swifly running stream.

## AN EFFECTIVE POWER WHEEL

MAKE two circular boards or wheels like *A* (Fig. 1), about forty inches in diameter. As it will not be easy to get single pieces of this width, it is best to make them of matched boards carefully nailed together with wooden battens, *C, C*. There must be a two-inch square hole, *F*, in the center of each disk. Through these fit the axle, *D*, which must also be two inches square. The disks, which are the ends of the wheel, can be placed as far apart as the width of the stream may demand, but forty inches is a convenient distance. The paddles, *E, E*, etc., are of the same length as the distance between the ends, and from ten to twelve inches wide. They are attached to the ends, by means of long screws or nails, on lines drawn from the center to the circumference of the end circles, and at equal distances apart. They should be only three or four inches apart, as their number determines the velocity of the movement of the wheel. The axle, *D*, should be rounded just outside of

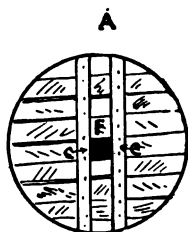

Fig. 1

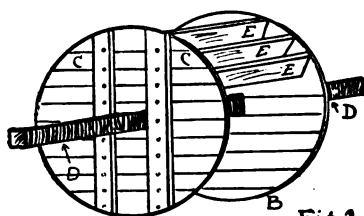

Fig. 1

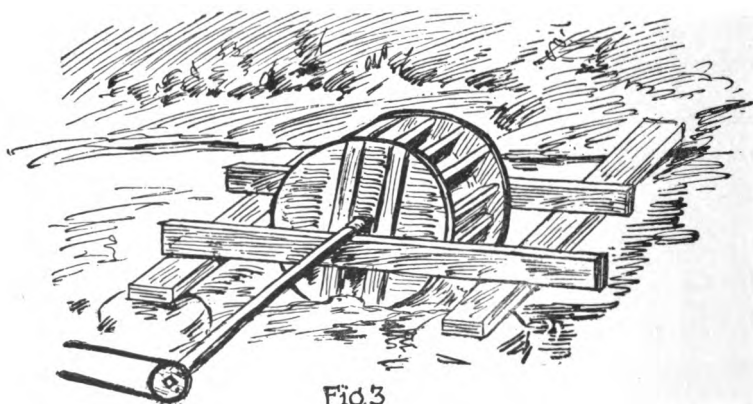

Fig. 3

### AN EFFECTIVE POWER WHEEL

each end of the wheel, in order to fit into the bearings. The end toward the bank of the stream should extend square as far as may be convenient, for attachment to the wheel that conveys the power to machinery.

As supports for this wheel, take two tree trunks or planks that will reach from bank to bank, and secure them in place about four and a half feet apart (Fig. 3). To the top of these attach firmly with spikes, at a distance of a little more than the length of the water wheel apart, two spruce planks two inches thick, ten inches wide, and a little longer than the distance between the tree trunks or first planks. At the top of the middle of each of these cross-planks make semicircular notches to hold the rounded part of the axle, and over this fasten a curved piece of iron or a big staple. The long end of the axle, reaching the bank, can be supported by a block of wood of the right height, and a wooden wheel be attached to convey the power to a distant wheel by means of a belt. Considerable power can be developed by this means.

## A PRACTICAL WINDMILL

UTILIZING wind instead of water as motor power for machinery is an art as old as civilization. The Dutch windmill with its ponderous sails made it possible for the people of The Netherlands not only to thresh their grain and grind their wheat, but to pump water into their canals and thus make waterways for their commerce.

A simple windmill, similar in construction to the water wheel just described, is made as follows:

Two pairs of paddles, *A* and *B*, are set at right angles with each other upon an iron shaft, *C*, *C*, which holds them rigidly in place together. This is fitted into a box, square at the bottom and of a height two-thirds of the other dimensions, which are but a trifle longer than the length of the paddles. One end, *J*, of the shaft should protrude sufficiently to be bent into a crank to work the piston, *H*, which in turn engages the machinery.

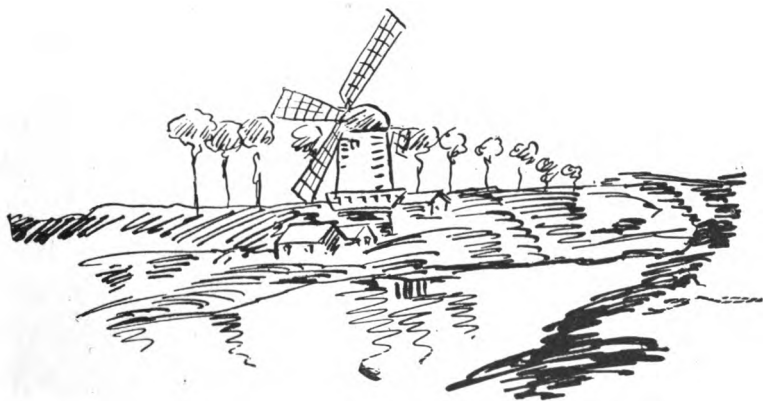
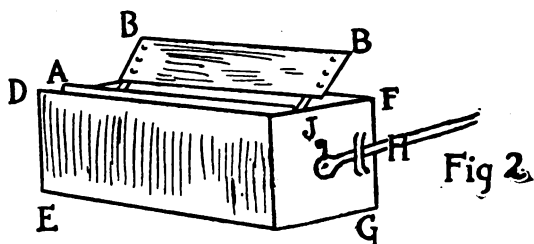
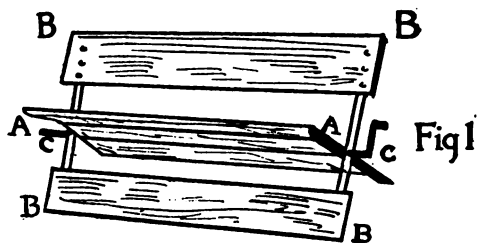



Only one paddle should show above the top edge of the box at a time. When the wind strikes this it drives it over and the next paddle comes into view. This in turn dives forward, and thus a constant revolution is kept up. The box can be shifted to catch the wind from any angle. The shaft must be well greased with oil or tallow, where it goes through the holes in the box. The bigger the box and the fan, the greater the power obtained.

This is not only a toy but a machine for practical results. It is a miniature of a kind of wind-power machine that is used as a motor with heavy machinery and for irrigation purposes in the West.

## PICTURE FRAMES

**THERE** is no more entertaining and at the same time useful pastime than the carpentry of picture frames. Almost any kind of wood will do for the purpose, and pleasing effects can be attained with the aid of a small saw. So many different kinds of moulding can be obtained at frame stores or of paper-hangers that the choice is unlimited. The best work, however, may be done by preparing your own wood.

A picture frame can be made in two ways: Mitered, that is, with the points cut at angles of  $45^\circ$  and joined along the edges, as *A*; or lapped, that is, grooved out and made to overlap, as *B*. There are other ways of joining, such as with square joints, like *C*. Fancy corners of brass, which can be obtained at a hardware store, can be applied at the corners, as in *D*, to hide any imperfections in the joints, or can be used at the top or bottom as decorations. The woodwork should be stained walnut brown or black.

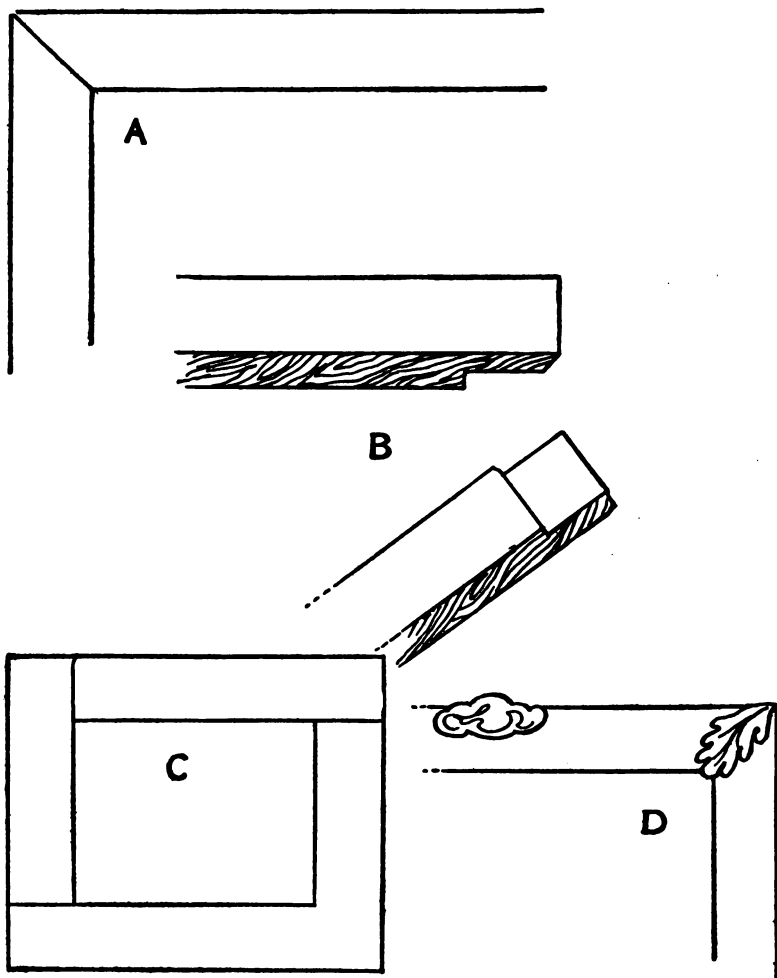

PICTURE FRAMES

In order to make a rabbet into which to fit the glass, strips of thin wood must be glued to the back of the frame to within a quarter of an inch of the edge. A mat helps set off the picture. This is easily cut out of rough paper or cardboard and should fit tightly into the rabbet. The opening can be made as large or as small as may be desired, and should be cut perfectly even and straight with a sharp-pointed knife, and a metal ruler as guide. In framing, put the glass in the frame next to the mat, and then the picture, with the face toward the glass. A stiff piece of cardboard should cover the back of the picture. Fasten the whole in with little wire brads or tacks, not more than an inch apart. To keep out the dust it might be well to paste a sheet of wrapping paper smoothly over the back. Two screw-eyes will serve to attach the cord to, by which to hang the picture.

To miter a strip of wood is easy if you have a miter saw and box, but if you have no miter box you can use a school compass, or dividers, to lay off a diagonal of  $45^\circ$  to the center edge. Lay off the line with a ruler and saw carefully with a fine saw; smooth off the edges with sandpaper. In joining, first apply liquid glue, then drive a few thin wire nails through the two edges.

## AN INGENIOUS CAMP STOOL

STANDING up is tiresome work, and a chair that can be folded into small compass and carried about, is a useful possession. It will prove a great convenience on a day's outing, at picnics, when camping, or watching a parade, and on a hundred other occasions when sitting is a more agreeable posture than standing. Here is a simple contrivance that any boy can make.

Make four strips of wood each about seventeen inches long, one and a half inches wide, and one inch thick, as *AB, CD, EF, GH*. Bore a hole with a half-inch auger half an inch from the top of each strip, also two inches from the lower end, and halfway from end to end. Into these holes fit five rounded dowels or sticks a half inch in diameter. Two of these sticks should be ten inches long, and three of them should be eleven inches long. The ten-inch sticks, *LL*, must be inserted into the holes to join the ends of two of the large strips, as *EF* and *GH*, and must be glued in to

keep them secure. Similarly two of the eleven-inch sticks, *MM*, should be inserted into the other two strips, *AB* and *CD*, and glued tight. The last pair of supports, *AB* and *CD*, can then be slipped over the first pair, *EF* and *GH*, as the connecting sticks are an inch longer. Holding the four center holes in line, slip the

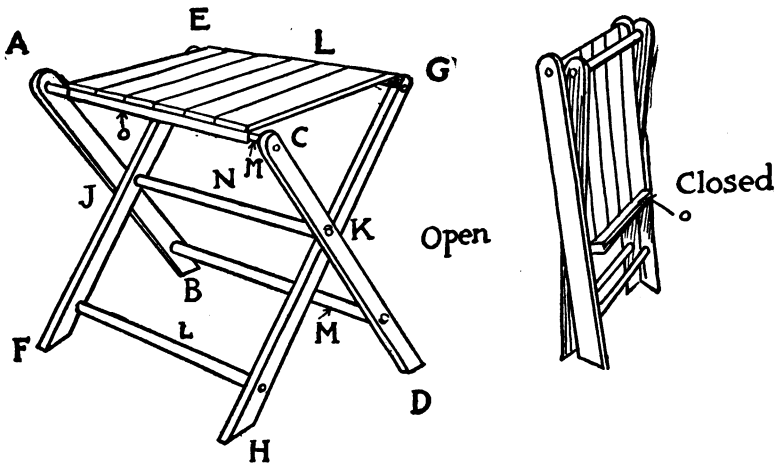

third eleven-inch stick through them, as a sort of hinge for the two pairs of supports to turn on. It must be glued only to the outer supports, leaving the inside supports to turn freely.

The seat can be made of a solid board, one-half inch thick and nine and a half inches square, or of narrow

matched boards, glued together and secured with a narrow half-inch cleat underneath each end. On one side, as at *E G*, this top is secured to the round stick, *L*, by means of a couple of half-inch staples, just wide enough to allow the top to turn easily about the stick. At the opposite edge of the seat is a crosspiece, *O*, of half-inch wood so attached as to fit over the round stick, *M*, running between *A* and *C*. This will prevent the stool from spreading out too far. Instead of a board seat a square of carpet, sewed around the two top cross-sticks, upper *M* and *L*, will also answer. The carpet should be bound around the edges to prevent raveling.

In folding, if the top is of wood, it is only necessary to lift it and push the cross-supports together, letting the top drop down upon them. The entire stool need not weigh more than four pounds. The woodwork should be carefully sandpapered, stained mahogany or oak, and varnished.

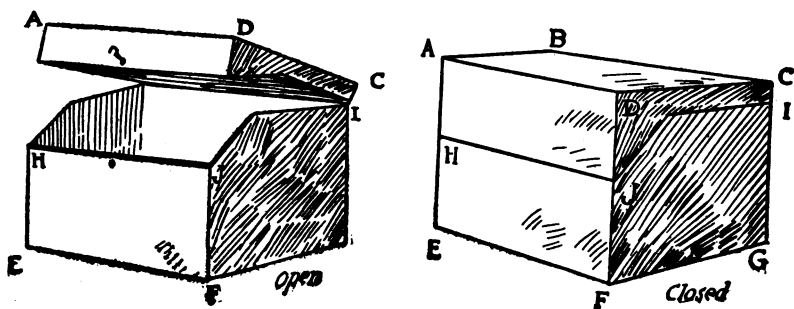

## A USEFUL BOX

THE illustration shows a box that is easily made and has a hundred uses, such as to store away letters, file card systems in business, and to file negatives of the photographs you have taken, or the mounted pictures.

Take wood three-eighths to one-half inch thick and make a box in the form of a cube of the required dimensions, nailing up all six sides. Mark off the shape of the lid with a pencil and ruler, as *H, J, K*, and with a fine saw cut along the lines. Begin at the front of the box for the upper slant and when you have reached the proper point, begin at the back and cut forward till the cuts meet. Sandpaper the edges carefully.

Join the lid to the box with a couple of small hinges; in the center of the upper front edge of the box and the center of the lower front edge of the lid adjust a hook and a brass nail, so the lid may be kept closed. The inside can be divided into sections, or vertical partitions made to fit and glued into place.



## FURNITURE AND FIXTURES

A bookshelf, such as shown in Figure 1, is made out of two grocery boxes, *A* and *B*, nailed one above the other. The wood must be carefully sandpapered and cleaned of any marks or imperfections. A bracket, *CD*, can be sawed out of thick boards, and will act as a support for the boxes. The shelf board should be as long and as wide as the boxes, and the completed bracket can be nailed to the wall, or supported by the wainscoting of the room, if that is high enough. The boxes should have two screw-eyes at the top about one inch from each end. Through these heavy nails are driven into the wall to make the bookshelf doubly secure. A neat little railing of wood, *E* (Fig. 1), two or three inches high, may be glued to the top around the back and the two sides. This will finish off the top, and will also prevent anything placed on it from falling off. The wood should be stained mahogany, and varnished.

A curtain can be made of any neat substance. It



Fig 1

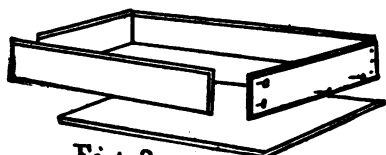
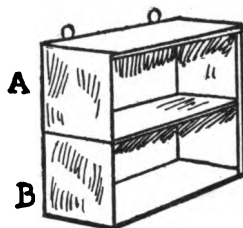

Fig 3

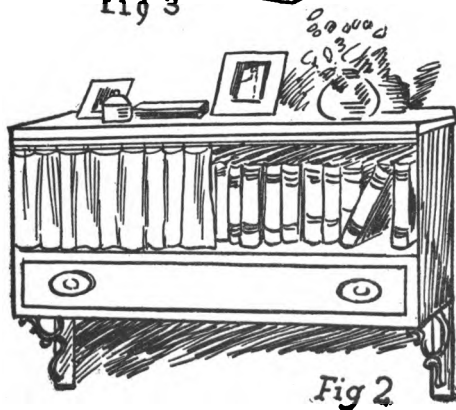

Fig 2

WALL CABINETS

should be just long enough to cover the front and about one third wider than the width of the shelf so that it can hang in folds. Little brass rings can be sewed on the upper edge, one inch apart. A brass rod with supports can be obtained at any department store, and the rings can slide on this rod.

A variation of this bookshelf is shown in Figure 2. Here there is but one shelf with a drawer below. If you can secure a long, high shoe box, this article may be easily made. Divide the box by a shelf into two unequal parts, the lower and narrower one to hold the drawer. This drawer is made by cutting one-half-inch boards into the proper length and breadth, as in Figure 3, and glueing and nailing them together, being careful to join them accurately with glue and small wire nails, and to get the whole structure perfectly square. In many cases a well-made packing box makes an excellent drawer. A thinner board will serve as the bottom. Attractive handles or knobs can be obtained at any hardware shop. In Figure 2 we show cast-iron brackets instead of wooden ones. They cost but a trifle and may be more convenient than the homemade brackets.

These shelves are an ornament to any room and a source of pride to their owner.

## BOOKSHELF AND CLOSET

AN ornamental as well as useful piece of furniture is represented here. It is easily made. The sides, top, and bottom are of three-quarter-inch board. The sides, *A, B, C, D*, and *E, F, G, H*, are five feet high by seven inches wide, and the top and bottom pieces twenty-eight inches long by seven inches wide. The side pieces should have a semicircle, the radius or line from the center to the circumference, of which is not more than five inches, cut out of the bottom to leave legs. The bottom piece, *I, J, K, L*, should be fastened to the sides six inches from the ground. A similar piece, *M M*, for the bookshelf should be fastened between the uprights ten inches from the top. Glue and screw these pieces together for the frame as shown in Figure 1.

This framework can be fastened against the wall and will then need no back; but if it is to be movable, a back of compo-board, the right size and shape, can be

obtained at a carpenter shop and is easily tacked into place onto the framework. An upright, *N N*, of the proper length and seven inches wide, is to be placed

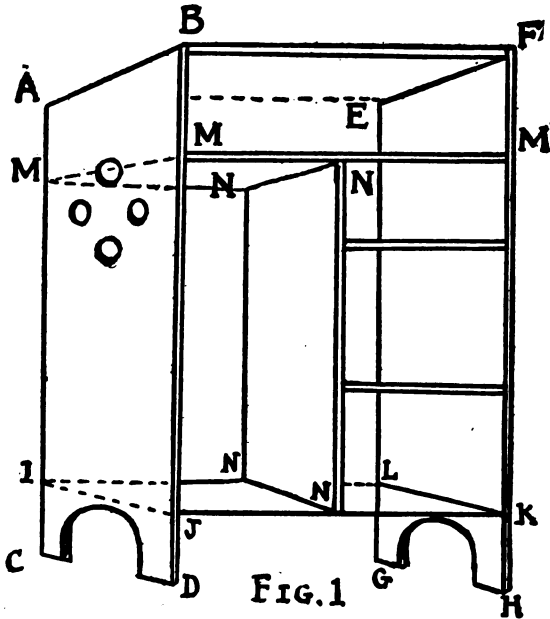

between the shelf and the bottom to divide the space into two compartments. A door for one of these can also be made of thin compo-board or of matched-and-grooved pine boards, cut into the proper size. There must be cleats about two inches wide screwed to the

back of it, to keep these boards together. A narrow molding can be tacked to the front to make an attractive panel. Ornamental hinges can be bought cheaply at a hardware store. Any number of shelves can be fitted into this space between the uprights.

The other compartment can be covered by a curtain of silk or creton. To this brass rings should be sewed an inch apart. A brass rod, cut to the right size, with inside fixtures may be obtained at a hardware store and placed between the uprights. On this the curtain slides. These receptacles are useful for your clothes, golfsticks, tennis rackets, and other valuable possessions.

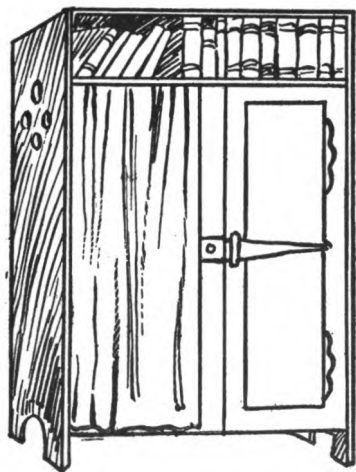

## A HANDY SHELF AND CLOSET

THIS wonderfully useful contrivance is easily made with the aid of an assortment of boxes. Large cigar boxes or starch boxes, the kind they have in grocery stores, will answer. Try to have them all of the same size, or at least the same depth. A bigger box for the lower drawer is preferable. After you have sandpapered the boxes to get them perfectly clean, build your framework so that they will fit in snugly. Wood for this should be one-half-inch pine, either solid boards or matched boards joined together. It is simply a matter of care and patience to fit these boards and glue and nail them into shape, so that they will hold the boxes, or drawers.

A large division at the top can be left for a closet, with a curtain before it, or a door hinged to it. The door should be made of matched boards, with two thin pieces of wood about two inches wide secured to the back to hold the boards together; or a piece of compo-

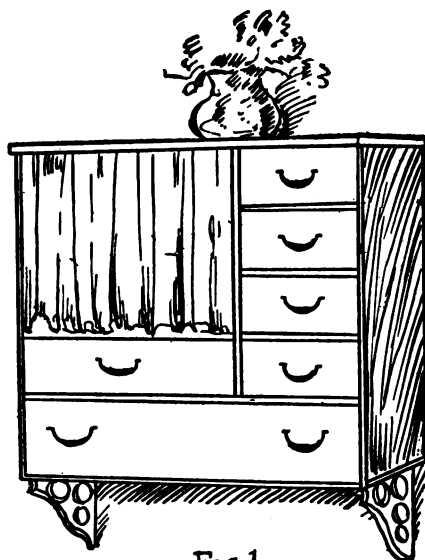

FIG 1



FIG 2  
WALL CABINETS



board will answer. It is not necessary to have a back to the closet. When completed, this piece of furniture may be attached to the wall by means of brackets. A lock should be inserted in the closet door and neat knobs or handles attached to the boxes or drawers. These may be obtained at any hardware store. The question of painting or staining the woodwork is optional with the maker, but it would be best to color it to match the other furniture. Figure 1 shows the finished article.

This article is useful as a receptacle for all kinds of games, sporting articles, balls, and fishing tackle, besides articles of clothing,—collars, ties, etc. The top can be used for bottles, drugs, or toilet necessities.

## A RUSTIC GARDEN SEAT

A COMFORTABLE and convenient seat for a garden, in the box of which can be placed all sorts of garden utensils, seeds, gloves, caps, etc., is easily made and will be found very useful.

A box, *A*, about a yard long, eighteen inches wide, and twelve inches deep, forms the foundation of this seat. If you can not get one ready-made, it will be easy to construct one out of inch boards. The top must extend about an inch over the front and be hinged on, to form a lid. The uprights, *B B*, are sawed out of one-inch boards and are thirty-three inches long. One side is vertical, the other slants from a width of about eighteen inches at the ground to three inches at the top. The bottom edge has cut out of it a semicircle, to form two legs on the ground. Four inches from this lower end, which stands upon the ground, the box should be securely fastened by being screwed to a cleat on each side, or, by screws through the box and the upright.

Two crossbars, *C C*, four to five inches wide, one at the top and the other halfway between that and the top of the box, should unite the uprights and form a



back. All the parts should be joined together by good, strong screws, and the entire piece painted green or some other desirable color that will stand outdoor wear.

## A CLOTHESHORSE FOR THE KITCHEN

THIS is a useful article of furniture, which can be folded into a very small compass and put out of the way. The bars are made of spruce, one inch thick and two inches wide. Four of the bars, *A A*, etc., are three feet, eleven inches long, and four bars, *B B*, etc., are one foot, eleven inches long. These form the supports or uprights that carry the cross-rods.

These cross-rods or dowels can be bought already turned at a carpenter's; or, if you want the credit of making the entire article yourself, you can use one-inch-square sticks, whittling down the ends till they are the proper cylindrical thickness of three quarters of an inch. These rods are of the following lengths: four rods are each four feet long; two rods are four feet, two inches long; two rods are three feet, ten inches long; and one rod is four feet, three inches long. This last is for the center and projects one and a half inches at each end, *C C*. A three-quarter-inch auger should be

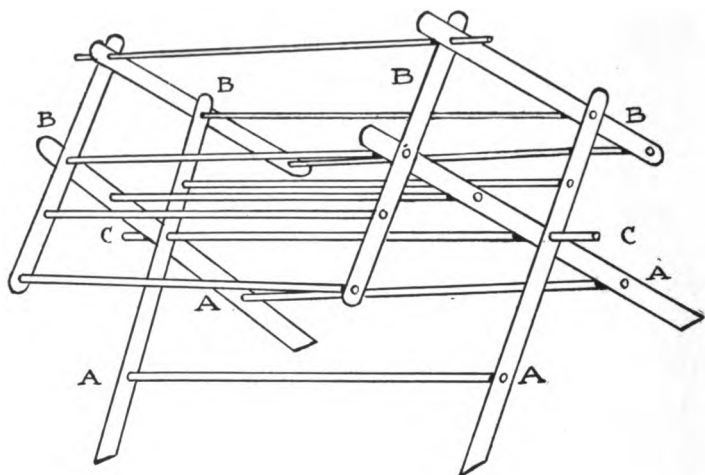

used to make the holes, into which the rods must fit snugly, but not so tightly as to prevent the uprights being moved.

It will take a little study of the diagram to join all these pieces properly, but the result will be gratifying to both the maker and the women in the laundry.

## A USEFUL BOX FOR SHOE BLACKING

GET a stout box (Fig. 1) about twelve inches square and nine inches high, with a lid to fit. Sandpaper it carefully. Cut the lid into halves by sawing it from end to end along the grain of the wood. One of these, the left edge of which is *A H*, attach firmly by screws to the body of the box. The other half, *K L, J H*, must be attached to the first by means of two strong hinges. Put castors, as at *B, C, and D*, at the four bottom corners, so that the box will slide easily along the floor. Now cut out of a board three inches thick, a piece, *M*, as near as possible in the shape of the sole of your shoe with one end cut out one inch deep to hold the heel. Open the hinged lid so that it lies back flat upon the other half. Screw this foot-rest onto the upper half of the open lid, so that it is in a position to hold the foot.

The interior of the box is useful for holding the brushes, blacking, etc. The wood should be painted

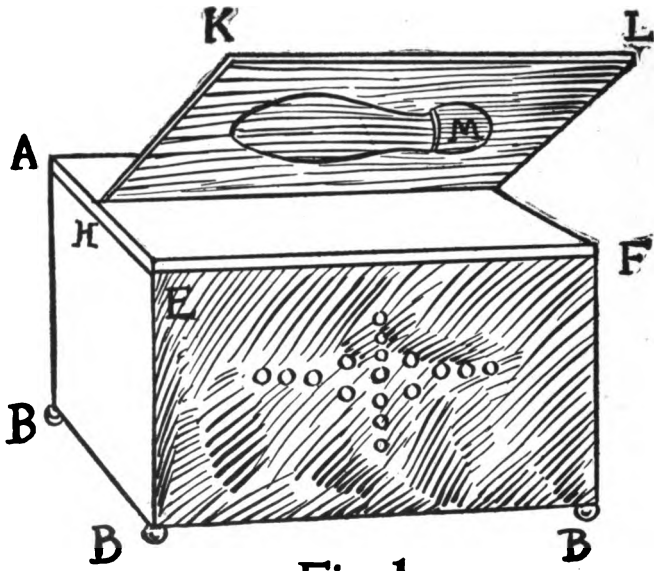

Fig 1

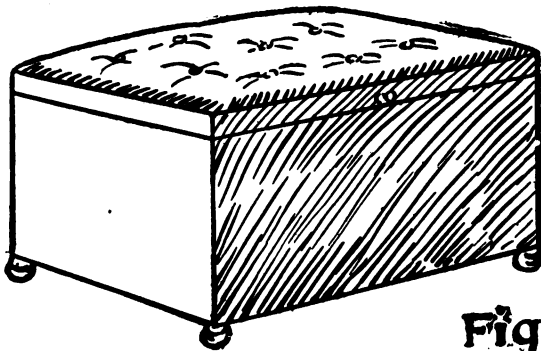
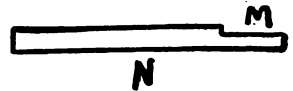

Fig 2

with white enamel paint, or stained some color that will match the woodwork of the room where it is to stand.

Figure 2 is a variation of this. The lid is in one solid piece and hinged to the box at the back. It can then be upholstered to match the furniture in the room, and be also used as a foot-stool or a low stool. The foot-rest for this box should be similar to the one described above, except that it must be mounted on a piece of wood a little wider than itself and long enough to reach from end to end of the box.

This board must be fastened to the ends of the box about three inches below the top, so that the foot-rest will not interfere with the closing of the lid, but as near flush with it as possible. It can be held by screws through the ends of the box or by being nailed to cleats, which are, in turn, screwed to the ends of the box at a proper distance from the top.



## A HOMEMADE STEPLADDER

ONE of the most useful and necessary articles in the home is a stepladder, and good ladders are expensive.

A four-step ladder can easily be made as follows:

Get two one-inch pine boards for the side supports, *AB* and *CD*. Cut them three feet long and four and one half inches wide. As these pieces must stand at a slant, like stairs, the bottom line must make an acute angle with the front edge of each board, and the top line must be parallel with the bottom, so that the top will be level and serve as a fourth step. Mark off with ruler and pencil three horizontal grooves in each support, at equal distances apart, parallel to the top and bottom lines, and in the same position in both supports. These grooves must be cut down about one-quarter of an inch into the wood, in order to hold the steps securely. The three steps, *EEE*, are made of one-inch board four and one-half inches wide and fifteen inches long. Insert the three steps into the grooves and fasten

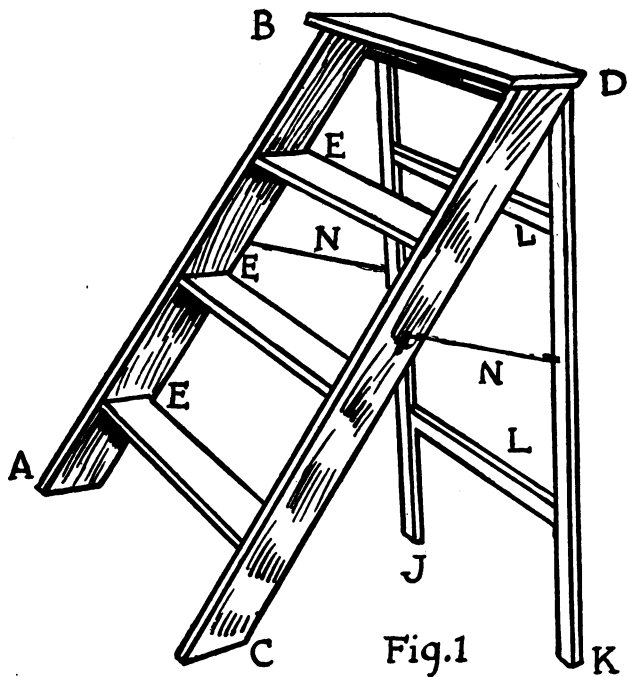

Fig.1

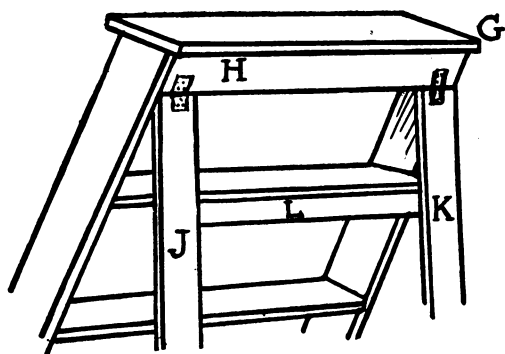

Fig.2

STEPLADDER

them with three screws in each side. Make and screw on the top shelf five inches wide and seventeen inches long.

Underneath the back of the top shelf nail a strip, *H* (Fig. 2), three inches wide and fifteen inches long. This is a support for the upright stilts, *J* and *K*. These should be three inches wide and just long enough to hold the ladder upright, when in the position shown in Figure 1. Two crosspieces, *L L*, three inches wide and eleven inches long, must be fastened between the stilts to give rigidity. The upper ends of *J* and *K* are next attached with strong iron hinges to the the cross-strip, *H*. Pieces of rope, *N N*, should be nailed with staples to the supports and to the stilts on each side of the ladder, to prevent spreading; or, better still, on each side a long wire hook can be hinged by a staple to the stilt and made to engage a screw-eye in the ladder support.

If carefully put together this makes a strong, durable ladder. More steps can be added by changing the dimensions.

## AN UMBRELLA STAND

UMBRELLAS are a necessity, for the rain descends on the just and the unjust alike. There is nothing worse, however, than to trail a wet umbrella through the house and wet the carpets or the inlaid floor with the drippings. Hence the desirability of a neat umbrella stand in the vestibule or hall.

Make four uprights, *B B, C C*, etc., of two-inch-square oak or spruce boards, twenty-eight inches long. Sandpaper them well. Next make eight side pieces of the same wood, three inches wide and nine inches long. With these make two squares, *E F G H* (Fig. 2), gluing the ends as well as screwing them together, so as to present smooth corners. Make a bottom of matched boards for the square that is to form the base, and nail it to the sides. Now attach the four uprights by means of screws first to the base, one at each corner, and then to the other square, forming the top. The framework is now complete.

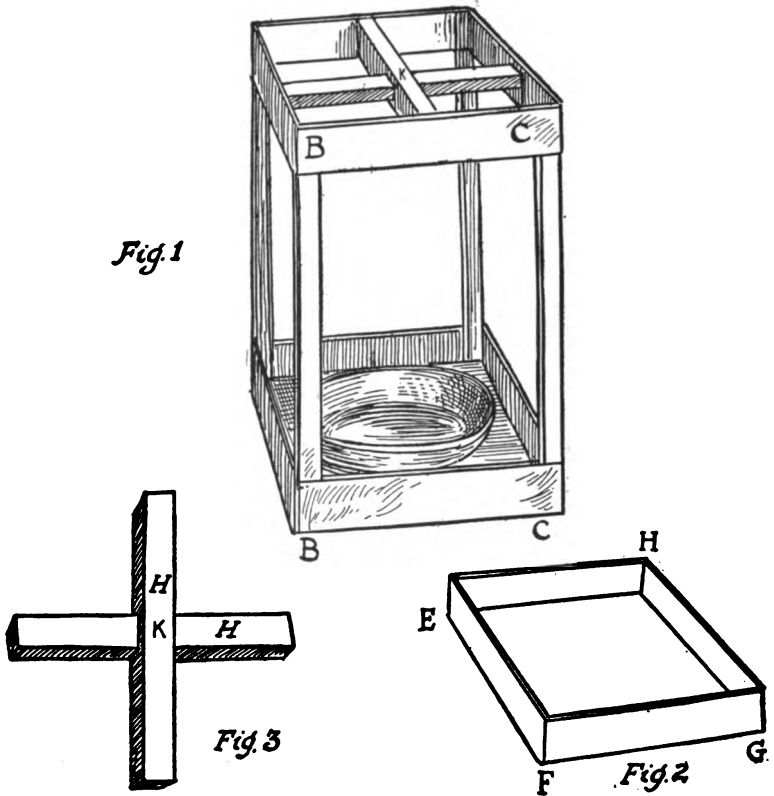

AN UMBRELLA STAND

The upper square should be divided into four smaller squares in order to hold four umbrellas separately. For this purpose make two pieces of half-inch board two inches wide, *HH* (Fig. 3). In the center of each cut out a piece half an inch wide and one and a half inch deep, so that the two sections will fit into each other as at *K* (Fig. 1). Place this within the top square of the stand and screw into position. A tin plate or dish within the bottom of the stand will serve to catch the drippings. The stand should be stained the color of the prevailing furniture, and varnished.

## AN ORNAMENTAL COAL-BOX

THIS article of universal use is easily made and will repay the labor bestowed upon it. The best way is to get a box about fifteen inches long, twelve inches wide, and eighteen inches high. These measurements are approximate and may vary. If no box can be obtained, procure the boards and make the box by simply nailing the sides together. Draw a line, *E D*, across the front halfway between the top and bottom, and saw through this. Then draw a diagonal line from each corner of the front, across the side, to the corresponding corner of the back of the box, as from *E* to *F* and from *D* to *G*. Saw through the sides along these lines; then the top of the sides will make an angle of 45 degrees with the back of the box.

Next get a board large enough to make a lid, *F, G, H, I*, which shall extend about half an inch over the front edge, *E D*, of the box. If you can not obtain a single board of this dimension, get matched-and-grooved

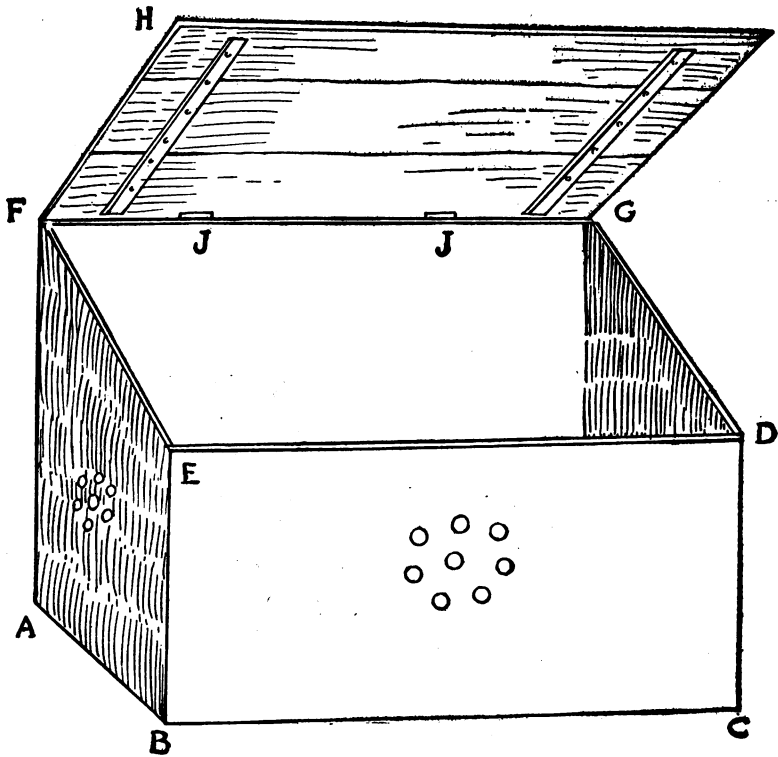

boards. These must be glued and kept together by two-inch cleats fastened to the under side. This lid must be attached by two brass hinges to the back of the box at *J* and *J*.

The box can be stained the color of the furniture in the room and a design of large brass-headed tacks made on the front and sides. Another form of ornamentation



is to paint a floral design on the woodwork, or to paste cut-out pictures on the wood and varnish the entire surface. As a receptacle for coal or wood, or a handy place to hide such articles as the dustpan and brush, this box is unequalled.

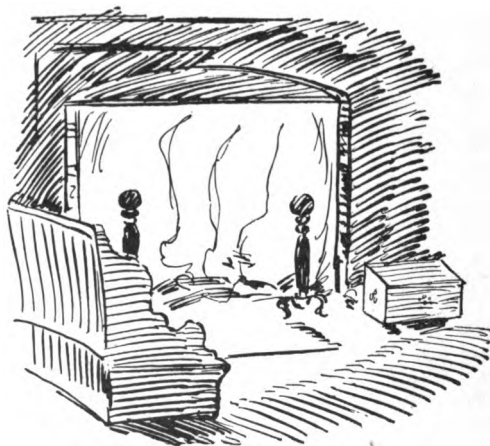

## A RUSTIC WINDOW BOX

IN many cities flowers bloom from nearly every window and lend an air of beauty and festivity to the street. In Berlin these window flower-gardens are among the chief beauties of the city; and the inhabitants, even in the poorer quarters, vie with each other in having a fine display. It is an easy matter to make a window flower-box that shall be not only useful but ornamental as well, and the humblest home can be made doubly attractive thereby.

The box must be just long enough to fit onto the window sill between the uprights, and about seven inches wide and six inches high. Plain square boards will answer, cut to the exact size and strongly nailed together. There must be a bottom, of course, but no top. Next get bark from a cedar, pine, or elm tree, and cut it into strips two inches wide and as long as the box is high. Tack these strips onto the front and sides of the box with the rough side outward. This will give the

box a rustic appearance. The side nearest to the window need not have any bark.

It will be well to have a tin lining to the box, to prevent the water from rotting the wood and leaking through. Any tinsmith will make this according to the

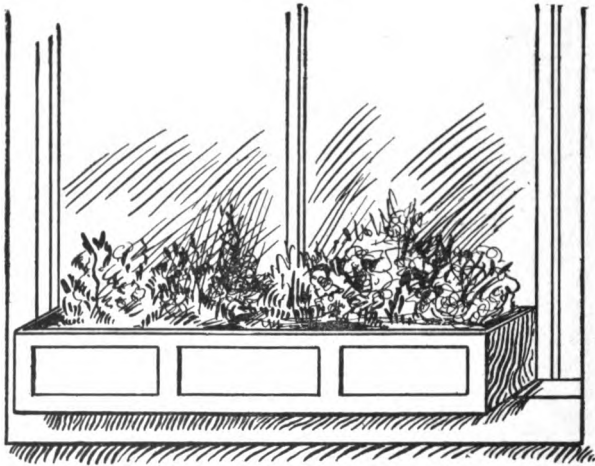

measurement of the interior of the box. Insert it, and tack it along the top to the woodwork. Fill the box with good earth and plant your flowers, and you will have a display of beauty that will last from early spring till late in the fall. You can also leave the plants in their earthen pots, and set these in the box alongside of each other, but it is better to plant the flowers right in the box. The rustic exterior can be improved by nailing crosspieces of bark over the strips.

## A CIGAR-BOX CABINET

CIGAR boxes, owing to their regularity and thinness, lend themselves splendidly to the making of many useful articles. One of the best is a cabinet of drawers, which can be used for a variety of purposes, such as a receptacle for sewing materials, school apparatus, or as a cabinet for minerals or other collections, of which every boy is fond.

Get as many cigar boxes, all of a size, as you may want drawers in your cabinet—say, six or eight. Clean them carefully of all paper and inky imprints, and sand-paper them. Now make your outer box or cabinet, being careful to measure the exact size required to hold all the boxes. For an eight-drawer cabinet, the box should be about sixteen inches high and a little deeper than the width of the cigar boxes. The width across the front, *D G*, should be twice as great as the front of two cigar boxes, plus one and a half inches. The outer box or cabinet can be made of half-inch

boards carefully glued and nailed together. There must be a central partition, *H I*, which extends from top to bottom and all the way back. This divides the cabinet into two equal parts.

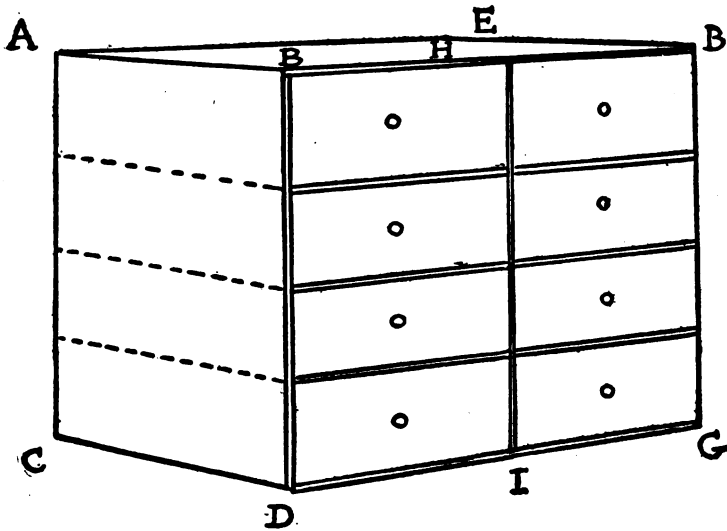

You need not have partitions between the boxes. A thin strip of wood, extending from front to back and attached to the side of the cabinet and to the partition, will answer to slide the boxes on. A far neater job, however, can be made by using the lids of the cigar boxes as partitions or floors on which to slide the boxes.

In this case glue each cover in its place as a shelf and tack it with small brads to the sides and central upright partition of the cabinet. The boxes can now be inserted, and will slide as drawers. The covers of the two



Top

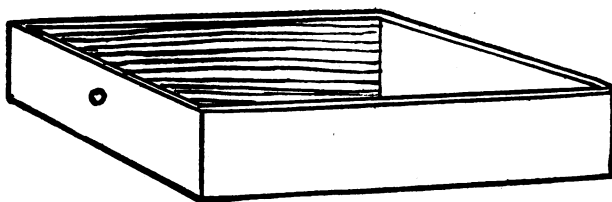

Box

upper boxes will not be needed.

The entire cabinet and drawers should be stained mahogany, and varnished. Neat knobs or brass-headed tacks can be used to pull the drawers out. A scroll-sawed top can be added to give the cabinet a finished appearance.

## A SUMMERHOUSE

MANY a pleasant hour can be spent in a summerhouse erected in the near-by woods, on the lawn, or in your garden. The summerhouse will be an incentive to spend more time in the open air, and offers a shelter from the sun, giving you a delightful place in which to read or play.

Its construction is very simple. The foundation consists of four spruce posts, four inches square and eight feet long. The ends should be embedded from a foot to eighteen inches in the ground, having been coated with asphalt, varnish, or creosote, to keep them from rotting. The posts should extend from six and a half to seven feet above the ground, and should form a square on the ground of six feet to a side. Across the tops of the posts, *A, B, C, D* (Fig. 1), nail two-by-four-inch joists, just long enough to reach from post to post, with the ends lapped or grooved to make a better joint. Nail all the ends securely with long wire nails.

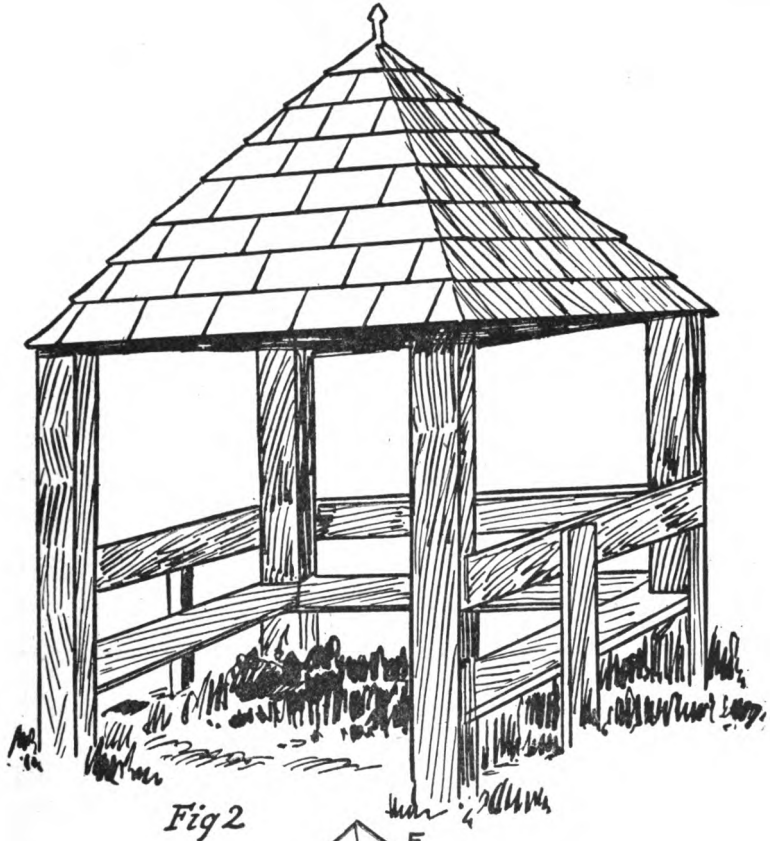

Fig 2

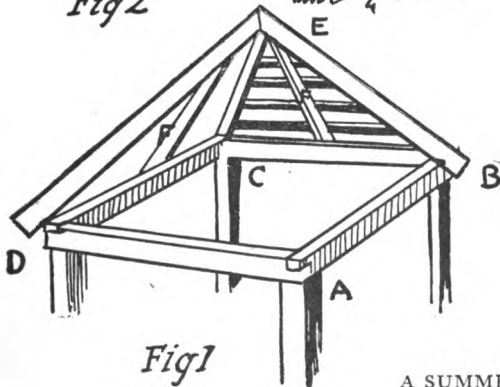

Fig 1



Now cut the joists to form the roof. These must also be two-by-four-inch boards. They should be about seven feet long. Miter them where they are to form a peak at the top, *E*, and cut a notch in each near the lower end where it is to fit over the crossbeam at the top of the posts, *D* and *B*. Attach two of these joists to two of the posts so as to bring them together in a point above the crossbeam, fastening them securely. Attach the other two joists in the same manner to the two opposite posts. Nail a shorter rafter, *F F*, to the middle of each of the two end crosspieces to join the main rafters at the peak. This will give you a solid foundation for the roof. Nail scantlings or laths to these supporting beams, and on this surface nail your shingles. The rafters should be long enough to hang about six inches over the line of the posts, *B* and *D*, as an overhanging roof will shed rain better. The shingles should be placed on the roof beginning at the middle of each side, and working outward toward the edges and upward toward the peak. The shingles should be laid close together, and each succeeding row should overlap two-thirds of the previous one. The joints between shingles in adjacent rows should not coincide, but should alternate. The edges of the roof where the shingles from both sides meet should be covered with

a narrow strip of tin, bent so that it will protect both edges and prevent the rain from leaking in.

Within the house three sides should have seats or benches. These are easily made by taking inch boards and sawing pieces into the right length—say, six feet—so that they will fit accurately between the upright posts. They should be mitered where they join the next board and a notch cut out where they fit around the posts. Nail them securely to the posts, and under the center of each seat place an upright of the same wood, of the right height from the ground to support it level. Above this, at the back of the seat, place another upright two feet high. A board three or four inches wide and long enough to extend from post to post should be nailed to this upright and to the posts.

All nails should be galvanized to prevent rusting. The wood should then be painted brown or some neutral color, or the posts can be covered with bark and a trellis of boughs can be placed between the posts. Great ingenuity can be used to make this a very pretty addition to any lawn. A rustic table consisting of the trunk of a tree cut to the proper height with a round or square top of wood might occupy the center of the house. These summerhouses can also be made round or oblong, the latter serving to shelter a hammock.

## GYMNASTIC HORIZONTAL BARS

FOR boys inclined to athletic sports a gymnasium is of greatest importance, and, considering the ease with which the necessary apparatus is made, every boy should have one. The yard is the best place to install the apparatus, as it adds the value of fresh air to the healthful exercise; but if there is no yard, the attic or an unused room offers splendid accommodations. The writer made himself a gymnasium in his garret that was the envy of every boy in the neighborhood, and many an impromptu circus was held in that room under the rafters.

The most important apparatus and the easiest to make is the horizontal bar. This consists of two stanch uprights and a crosspiece. It is very simple, but it is necessary to have it secure in order to avoid accidents. The uprights should be of strong, four-inch-square planks of ash or spruce. If the ceiling of the room is not too high, they should extend from the floor to the

ceiling, and be fastened at both ends. If the ceiling is high, make the planks seven feet high. Place them on the floor four feet apart, and secure them with four right-angle irons to each upright. These angle irons can be had at any hardware store. They have two or three screw holes on each side of the "L."

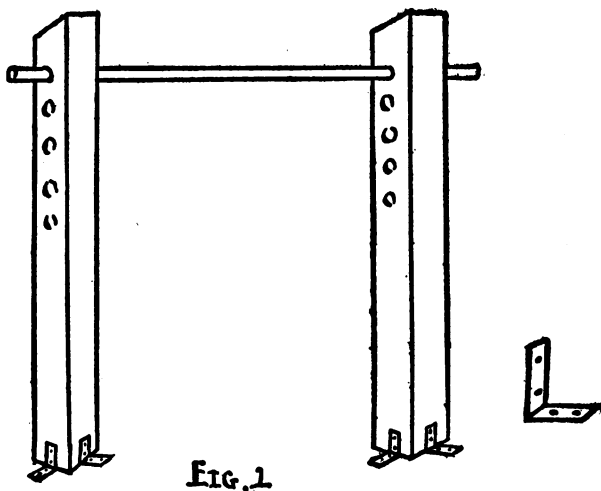

Before fastening the uprights, bore with an inch auger four or six holes, one above the other, about six inches apart and exactly at the same distances from the ground or floor in both uprights. Next get an iron rod three-quarters of an inch in diameter and five feet long. If you can get a good crossbar of ash or hickory of the

right size it will answer, but the iron rod is safer, as it will not break. Slide it through the uprights at the desired height, and your apparatus is ready for use.

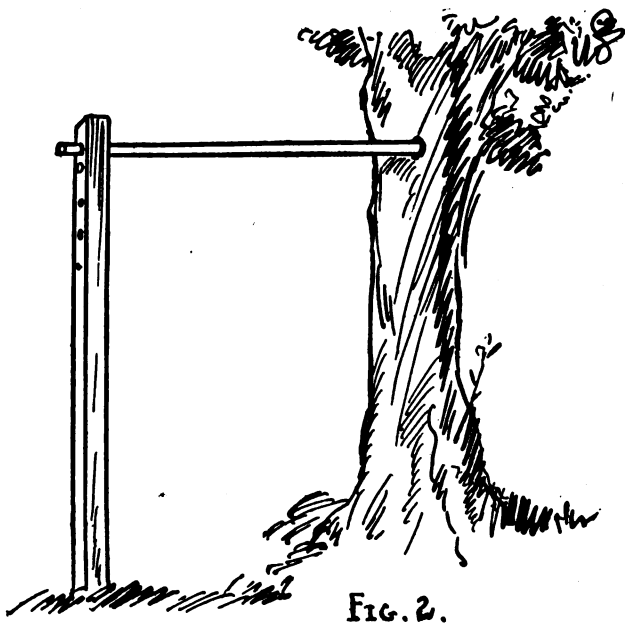

If the apparatus is to be installed in the open air, a tree will serve very well as one of the supports, with an upright of wood for the other; or two trees conveniently placed to hold the horizontal bar will do away with the necessity of uprights entirely.

## PARALLEL BARS

USEFUL members of the gymnastic family, twins in fact, are the parallel bars, which if properly used develop the arms and chest, and afford both health and amusement. While not as easy to make as the horizontal bar, they should present no difficulty to the young mechanic.

The first requisites are four uprights of strong, hard wood, four inches square and four feet high. The height must depend upon the age and size of the boys who expect to use the apparatus. The uprights must be placed to form a rectangle on the ground four and a half feet long and two feet wide. The bottom ends must be fastened to the floor by means of four strong, iron, L-shaped braces for each upright, attached by means of six screws each. These braces can be had at any hardware store. Across the four-inch-wide top of each upright, in a line parallel to the long sides of the rectangle made by the posts, chisel out a groove two

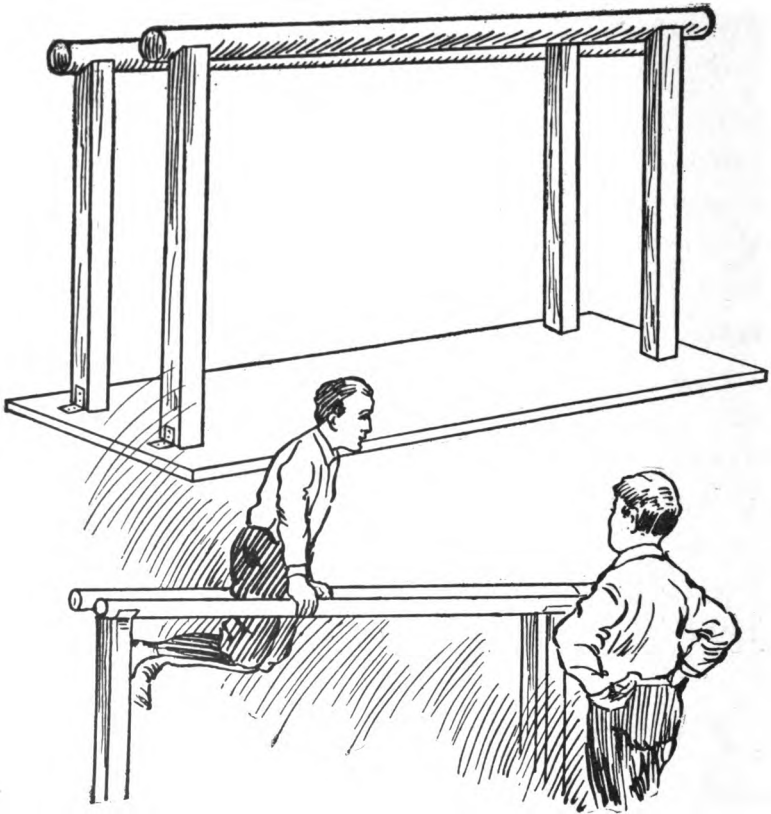

PARALLEL BARS

inches deep and two wide. These are to hold the parallel pieces.

The bars should be made of strong hickory, five feet long, two inches thick, by three inches deep, or they can be round. The upper edge should be carefully rounded and sandpapered, so as not to leave any splinters to enter the skin of the hand. It would be better to have the bars rounded for their entire distance, like a pole, except where they fit into the uprights. There they should be rectangular to fit into the openings just prepared for them. The ends should extend three or four inches outside of the uprights. The bars must be carefully oiled or varnished in order to enable the hands to slide more comfortably. The exercises that may be done on bars are numerous, and can be learned from any good book on gymnastics.



## SWING AND TRAPEZE

THERE is probably no apparatus more simple and yet more productive of pleasure for the whole family than a swing. It consists of a simple board, *A* (Fig. 1), an inch thick and as large as may be found desirable to sit on. Bore two holes on each side with a one-inch auger, and through these pass a strong rope, knotting it at the bottom, beneath the board, or splicing it so that it will, when stretched, come to six inches above the board, *C*. A similar rope must be inserted through the holes on the opposite side of the board. If the swing is to be attached to a tree, the two supporting ropes should be thrown about the branch, the width of the seat apart, and the loose ends spliced to the main line, *D*, about six inches below the branch, so as to allow free play for the loop. The ropes should be sufficiently long to reach to within eighteen inches of the ground. The lower ends are then slipped through the triangular loops in the board and strongly spliced. There are

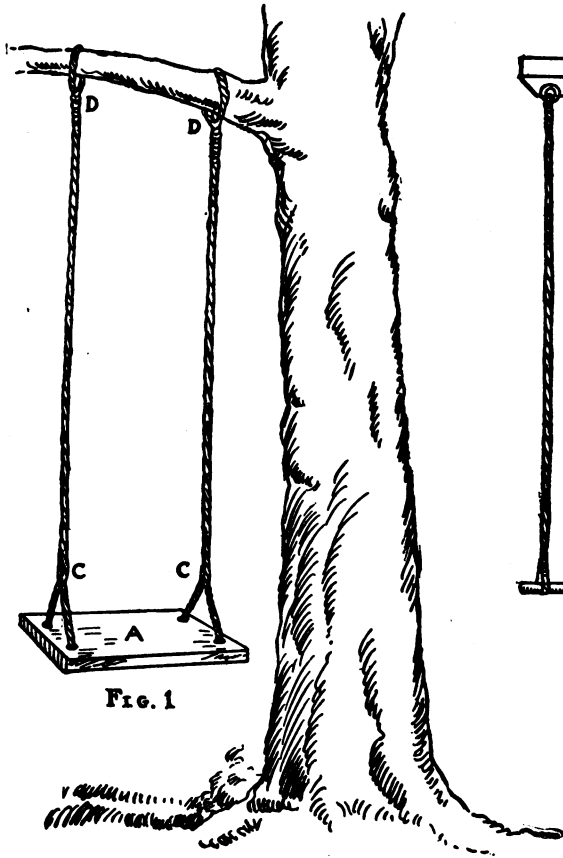

FIG. 1

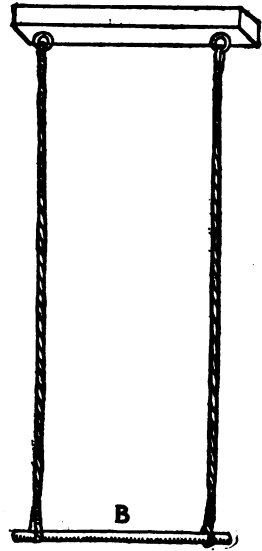

FIG. 2

SWING AND TRAPEZE

many other ways in which the rope can be fastened, but this is the simplest and safest.

To make a trapeze (Fig. 2), use a bar of iron or of strong hickory wood, *B*, one and a half inches in diameter and twenty-four inches long. It must be carefully rounded and sandpapered. The bar must be notched about two inches from the ends, to hold the rope securely. This can be attached to a tree as the swing was, but if it is to be used in a room, find a cross rafter and screw into it two strong, galvanized eye-hooks large enough to support a two-hundred-pound weight. The upper ends of the ropes are run through these hooks and spliced to the rope about three inches below them. The lower ends of the rope are brought tightly around the notched ends of the bar and carefully spliced. The height of the trapeze should depend upon the size of the boy using it. Caution is needed in seeing that the ropes are properly fastened and that the hooks are secure, as "it is better to be safe than sorry."

## WIGWAMS

NEXT to fighting Indians, the healthy, full-blooded boy wants at times to be an Indian and live in a wigwam. A very good, serviceable tent to house the noble Red Man can easily be constructed in the back yard.

Go out into the woods and cut twelve straight spruce poles about ten feet long and as free from knots and curves as possible. These poles should be two inches thick at the bottom and taper up. Take four of these and tie them together about a foot from the upper ends. Spread out the bottom ends so that they form a square about six feet each way. Then arrange the other poles around this skeleton so as to form a circle, and lash the tops together with a stout rope (Fig. 1).

Now get unbleached muslin or light sailcloth to form the covering. Have this about three feet wide. It will take some little calculating to make the covering to fit. The best way is to measure the circumference around the base of the poles, and lay out on the ground

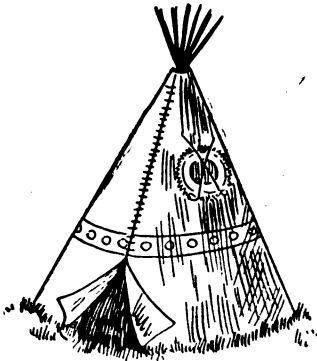

Fig 2

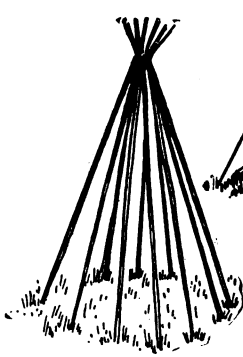

Fig 1



Fig 4

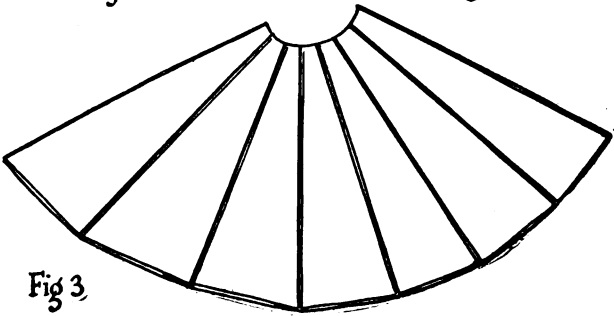

Fig 3

WIGWAMS

a circle (Fig. 3) a little larger than this distance. Then measure the sides of the segments from the center and cut enough muslin to cover each of the segments between the poles. Sew them together and bind the bottom and the ends with clothesline to prevent unraveling, and also to have a solid edge by which to fasten down the covering. This rope should be sewed securely with waxed thread.

Use rope to lash the bottom of the muslin to the poles; the top must be bound around the neck where the poles meet. Pegs driven into the ground will keep the bottom in place. Where the flaps meet in front an opening should be left for the door. This should be about four feet high. The muslin can be decorated with all sorts of Indian hieroglyphics, daubed on with red and blue paint.

BY arranging the poles in the form of a square instead of a circle, a square tepee is formed (Fig. 4). The covering of muslin must then be cut in four triangles of the required dimensions, and sewed together. This is then slipped over the poles and held fast at the bottom by means of pegs driven into the ground. The front side is cut halfway up to form the door. The flaps can be so arranged that the door can be closed completely, the flaps overlapping.

## NOVELTY PAPER BOXES

THE making of pasteboard boxes affords great opportunity for originality, and many a pretty receptacle can be made with very little expense or trouble. As Christmas gifts they are particularly acceptable and their construction furnishes agreeable occupation for the invalid or convalescent.

For an oblong box without special characteristics, any folding box will serve as a model. In the illustration we give indications how several odd boxes, to contain candy, etc., are made.

For the box shown in Figures 1, 2, and 3, use strong card- or Bristol board. Lay out all your lines with a pencil and ruler, being exact as to distances. Have all your angles right angles, or the box will not close properly. The length and width of the cover must be one-sixteenth of an inch greater than those of the bottom. You must *score* along the dotted lines; that is, make an indentation with a sharp point, but not cut through the

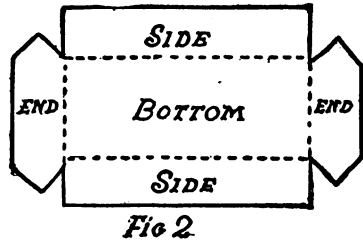
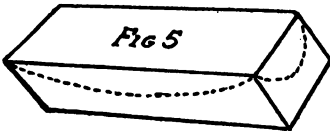
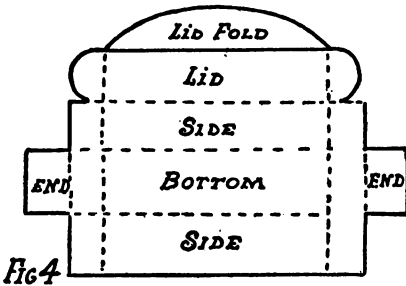
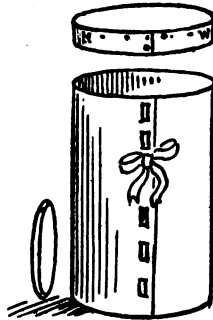
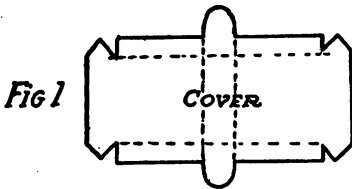
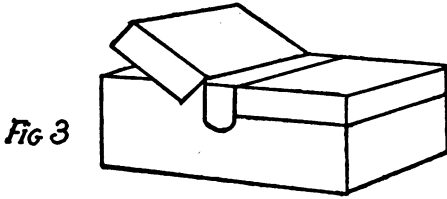



card. Then turn up the sides and edges along the scored lines, and paste the triangle flaps securely to the sides.

The cover is then put on the box and the longer, rounded flap in the center of the cover is pasted down over the sides of the box. The cover can then be opened from either side. A partition dividing the box into two equal parts may be useful to keep two kinds of candy or fruit separate. Ribbons can be used to tie the covers down. Pictures cut out from magazines or books will serve to decorate the box.

A box with cover attached (Fig. 4) can be made as follows: Map out your stiff cardboard as before, using this diagram. Score along the dotted lines and fold carefully. Paste the flaps to the edges of the sides. Fold over the rounded part of the lid and your box is completed. A dainty ribbon will hold the contents in place.

A round box (Fig. 5) can be made as follows: Cut a circular disk out of cardboard about one-half inch thick. The diameter of a second disk required for the cover should be one-sixteenth of an inch wider than the other. Then cut a square or oblong sheet of heavy Bristol board one-half an inch longer than the circumference of the disk and as wide as the box is to be high,

This is to allow a flap for pasting. A smaller sheet will serve as the cover. Nail the bottom of the sheet all around the disks, with little brass tacks. Paste the flap over the other edge, and your box is complete. The lid is made the same way. Instead of pasting, the edges can be kept together by a cord, or baby ribbon threaded carefully through both thicknesses of cardboard.

## SLINGS

SLINGS belong to the world's most ancient weapons. We read in the Bible how brave little David killed the mighty Goliath with a stone from his sling. Ancient armies had whole regiments of skilled sling-throwers, just as armies have cavalry soldiers to-day. Shakespeare speaks of the "slings and arrows of outrageous fortune."

It is easy to make a sling (Fig. 1). Take an oval piece of leather about three inches long. Fasten a leather thong to each end and put a stone in the center of the oval. Wrap the larger thong around your hand, holding the shorter thong between your thumb and first finger. Whirl the sling several times around your head, and let go the shorter thong. The stone will fly to a considerable distance, according to your skill and force.

This movement is due to what is called centrifugal force. When a thing rotates, or is whirled about in a

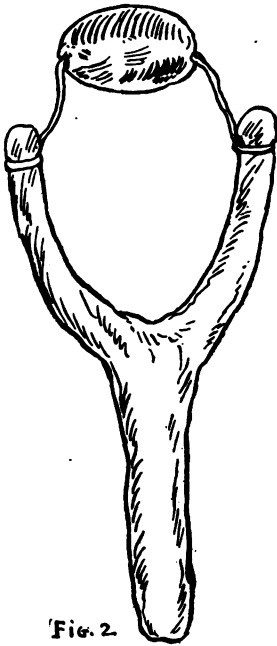

Fig. 2.

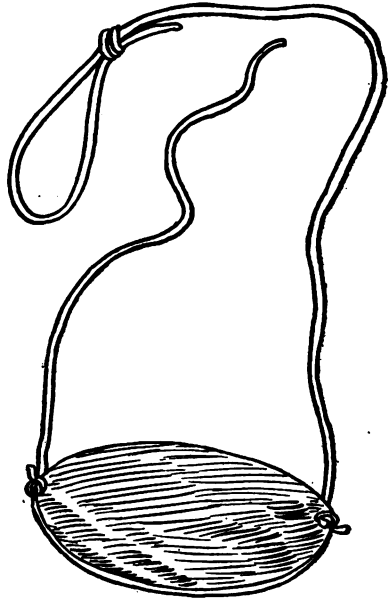
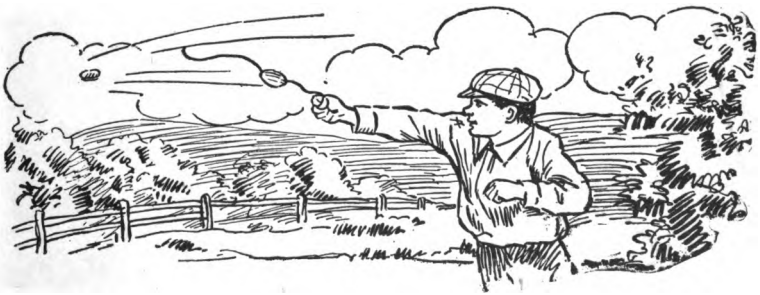

Fig. 1.



SLINGS

circle, it tends to fly off at a tangent to the circle. As long as the leather holds the stone it can not fly, but the moment the thong is released the stone escapes at right angles to the radius of the circle.

Another form of sling shot (Fig. 2) is made by means of a bent twig and a strong piece of rubber. The distance it speeds depends on the elasticity or springiness of the rubber. The stone or missile is put in the leather and held between the thumb and index finger. The leather is pulled back as far as the rubber allows, and then suddenly released, and the stone flies out of the leather holder.

## THAUMATROPES

AN amusing toy, which works on the order of the moving-picture film, and which proves that the eyes are not always to be trusted to see things exactly as they are, is made as follows:

Cut out a circular piece of cardboard about two inches in diameter. Draw on one side the picture of a bird cage, on the other side a bird. Attach two pieces of string, six inches long, to each edge. By holding the ends of the strings between the thumb and forefinger of each hand and twisting the disk around rapidly, the bird will appear to have entered the cage.

Other pictures can be drawn in the same way, such as a horse and a rider, a juggler and two or three balls, etc. Pictures such as the horse and rider must be drawn upside down, or the reverse of each other. The rider will appear to be leaping on or under the horse. Other variations will easily suggest themselves.

The reason of this optical illusion is that the retina of the eye had not yet lost the impression of the first object before it received the second. Thus the idea

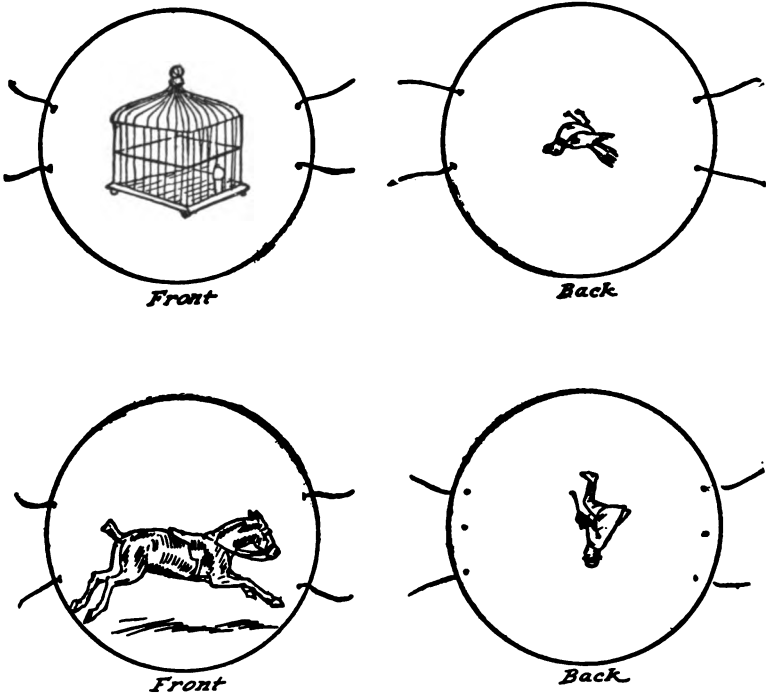

of one object only is conveyed to the brain. In moving pictures the different photographs are seen by the eye in such rapid succession as to make them appear as one continuous picture, and therefore in motion.

## A HOMEMADE TALKING MACHINE.

Where does the music come from in a talking machine? The question is often asked. A little experimenting will show that the melody is in the record. The sound-box, arms, horn, etc., serve only to increase and direct the sound. The motor is useful only to turn the record at a regular speed. To prove this, try the following experiment: Take a sheet of stiff writing paper and wrapt in the shape of a cone. Insert a pin or a pointed toothpick in the lower end near the point, Fig. 1, and hold this over a revolving record so that the pin's point follows the spiral lines of the record. You can hear the music faintly but distinctly.

To make a practical phonograph for the use of any lateral disk record, saw out of hard wood or bamboo a tuning fork like that shown in Fig. 2, about eight inches long and two inches wide. Cut it down to one inch from *C* to *B*. There should be a space of one inch between the prongs. Make a small hole an inch



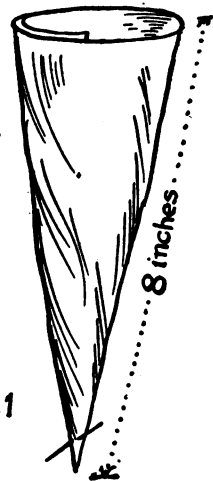
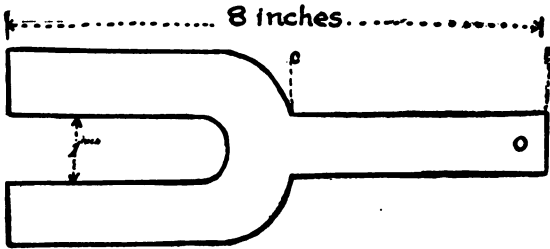
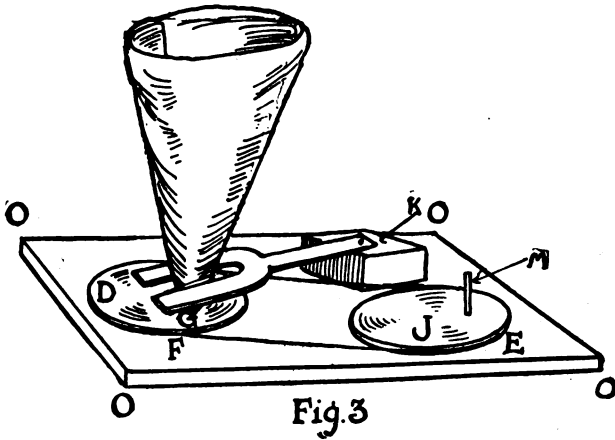

Fig. 2

Fig. 1

A HOMEMADE TALKING MACHINE

from the end *B*. Make an oblong base of half-inch board sixteen inches long and eight inches wide (Fig. 3, *O-O*). Cut out two circular disks of wood *D* and *J*, one-half inch thick, each six inches in diameter. The circumference of each should be grooved, as at *E* and *F*, to hold a string or belt in order to convey the power from one to the other.

Make a hole in the middle of each disk, through which insert screws to fasten the disks to the base at *G* and *J*. The distance should be so arranged that the edge of *O* comes within one-half inch of the left edge of the base, and the edge of *E* within one-half inch of the right-hand edge of the base. One disk, *J*, must have a peg, *M*, two inches long, inserted near the circumference to use as a handle for turning. A strong string or belt of thin leather or cord connects the two disks so that on turning *J*, the other will also revolve. A screw at the center of disk, *D*, must extend upward a half an inch to hold the record. This disk should be covered with felt or cloth so that the record will not slip. Make a block of wood about two inches square and three inches high, *K*. Fasten it onto the base near one edge, at such a distance from the disk *G* that the fork attached to the center of the block will reach from it to an inch beyond the center of the disk *G*. Have a

wire nail extend upward from the block about an inch. On this slip the fork, the hole at *B*, Fig. 2, fitting loosely over the wire nail.

Make a long cone of stiff brown wrapping paper about eight inches high and tapering to a point, Fig. 1. Paste the edges so that it will retain its shape. Insert a sharp Japanese toothpick or needle through the lower end near the point of the cone at an angle of 45 degrees, with the sharp end downwards. Insert this horn between the prongs of the tuning fork in such a way that the point of the toothpick will reach to the outer edge of the record's spiral and move freely toward the center. Use a Victor or Columbia record, the kind with the lateral cut. Place the record on the disk over the protruding screw, at *G*. Turn the disk *E* by means of the handle *M*, and both disks will revolve. Regulate the speed according to your needs. The toothpick will transmit the vibrations of the record to the paper horn, which will augment the sound and make it audible through the resonance of the fork. Practice will show you the proper speed and the right direction in which to turn the disk.

You can thus have your own orchestra at home with but little expense.

## A VIBRATORY TELEPHONE

To make a magneto-electric telephone is a difficult matter, as it requires great skill in the winding of the magnets, and considerable outlay for material. It is an easy matter, however, to make a telephone that depends on vibrations sent through a cord or wire, which will serve to convey the voice for quite a distance. From one boy's home to another or in camp it is useful and practical.

The foundation consists of two cigar boxes, Fig. 1. Take off the lid on one side and cut down each box so that it is square. Replace the lid of one box so that the box is closed. First, however, cut in the lid a hole whose circumference will come to within two inches of the edges of the box, *R. o.*, Fig. 2. In the exact center of the bottom of the box cut a hole about four inches in diameter, *T. T.* Back of this, to form a diaphragm, glue a piece of heavy cardboard or wrapping paper, *E.* The paper should be glued on while wet, and when it

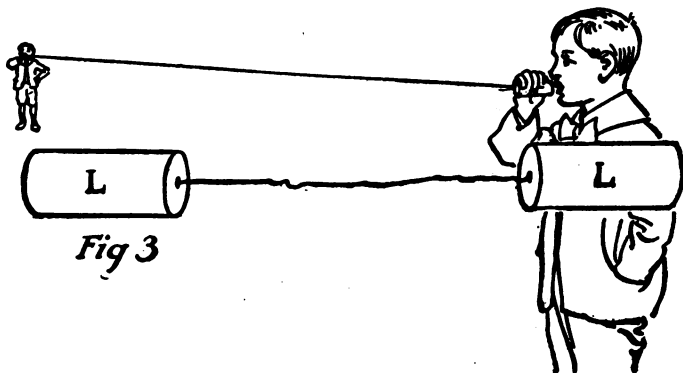
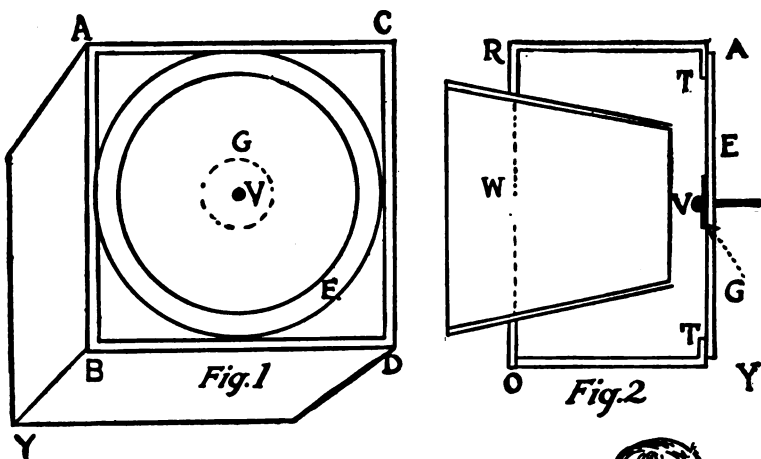

A VIBRATORY TELEPHONE

shrinks in drying it will be as tight as a drumhead. A washer or circle of pasteboard, *G*, two inches in diameter, should be pasted on the inner surface at the center. If the telephone is to be placed against a wall, another washer must be placed on the rear of the diaphragm. Make a small hole through the washers and diaphragm and through this run your line wire or cord, to the end of which tie a shoe button to prevent its slipping through, *V*. For the mouthpiece make a funnel or cone out of pasteboard, large enough to fit into the opening in the front of the box, *W*. This will direct the sound toward the diaphragm.

A similar box is made for the other end to receive the message. The line wire should be run as tightly as possible. The results depend upon the tenseness of the line. If it runs in a straight line there will be no difficulty in attaching it to posts or boughs, but this must be done in such a way that it does not touch any solid matter, for that would mar the vibrations. It should be suspended by strings of thread. If the line runs through a hole in a wall, keep it from touching the wall. Where the line must make an angle, the best way is to suspend a metal ring at the point of turning and let the wire run through it. Fine piano wire gives the best results. The diaphragm can also be made of tin.

A simpler form of telephone consists of a round pasteboard or wooden box without a bottom, *L*, Fig. 3. Over the lower opening glue strong parchment paper, and run strong, thin cord through a small hole in the exact center. A button or knot will serve to keep it from slipping out. A duplicate of this for the other end completes the telephone. Two boys carry the boxes apart the length of the string and talk into the opening as a mouthpiece. The sound carries perfectly for a considerable distance. The string must be held as taut as possible to get the best results.























89098709819



B89098709819A

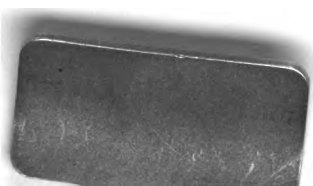
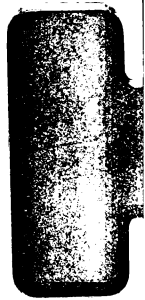

89098709819



b89098709819a