

AT MICROFICHE
REFERENCE
LIBRARY

A project of Volunteers in Asia

The Tropicutor Operator's Manual: Field Operations

by R.K. Bansal

Published by:

ICRISAT
Patancheru P.O.
Andhra Pradesh 502 324
INDIA

Available from:

same as above

Reproduced by permission.

Reproduction of this microfiche document in any form is subject to the same restrictions as those of the original document.

THE TROPICULTOR

Operator's Manual:

FIELD OPERATIONS

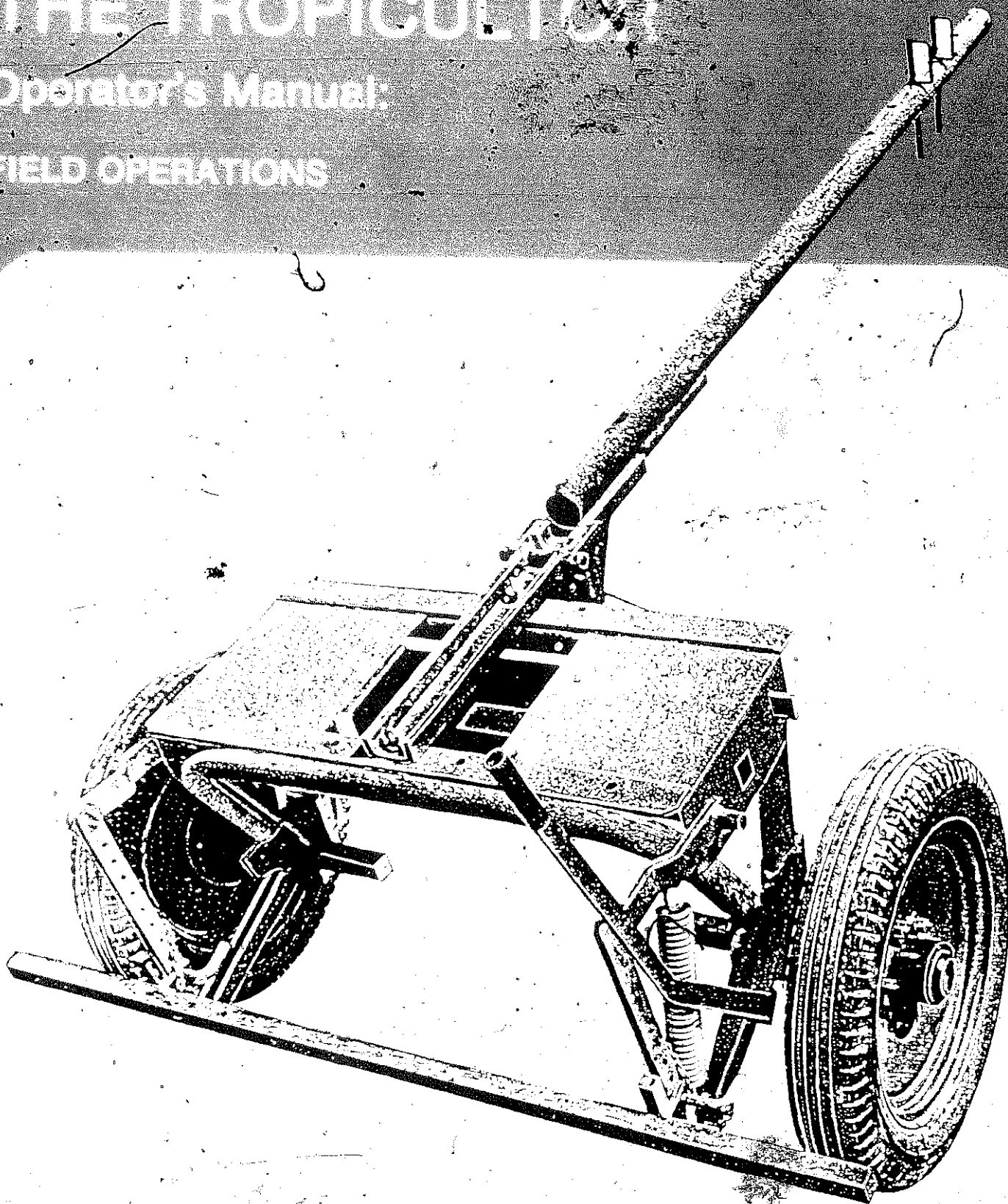

International Crops Research Institute for the Semi-Arid Tropics

THE TROPICULTOR

Operator's Manual:

FIELD OPERATIONS



ICRISAT

INTERNATIONAL CROPS RESEARCH INSTITUTE FOR THE SEMI-ARID TROPICS
Patancheru P.O., Andhra Pradesh 502324, India

1985

THE TROPICULTOR OPERATOR'S MANUAL: FIELD OPERATIONS

Compiled by R.K. Bansal

Publication of this manual has been funded by the New Zealand High Commission, New Delhi.

Grateful thanks are also due to G.E. Thierstein and many people, within ICRISAT and in collaborating organizations, who participated in creating the manual's preliminary shortened version, in testing it for comprehension among selected users, and in producing this complete version for publication.

The Tropicultor is derived from an animal-drawn wheeled tool carrier designed by Jean Nolle. It has been modified by ICRISAT after many years of testing and adaptation, and is particularly recommended for use by farmers who adopt the watershed-based farming system now being verified on-farm in four states in central India.

Further information and advice, including the names of manufacturers in Latin America, Europe, and South Asia, are obtainable from the Program Leader, Farming Systems Research Program, ICRISAT, Patancheru P.O., Andhra Pradesh 502324, India.

The International Crops Research Institute for the Semi-Arid Tropics is a nonprofit scientific educational institute receiving support from donors through the Consultative Group on International Agricultural Research. Donors to ICRISAT include governments and agencies of Australia, Belgium, Canada, Federal Republic of Germany, Finland, France, India, Italy, Japan, Netherlands, Nigeria, Norway, People's Republic of China, Sweden, Switzerland, United Kingdom, United States of America, and of the following international and private organizations: Asian Development Bank, International Development Research Centre, International Fertilizer Development Center, International Fund for Agricultural Development, The European Economic Community, The Ford Foundation, The Leverhulme Trust, The Opec Fund for International Development, The Population Council, The Rockefeller Foundation, The World Bank, and the United Nations Development Programme. Responsibility for the information in this publication rests with ICRISAT.

Correct citation: ICRISAT (International Crops Research Institute for the Semi-Arid Tropics). 1985. The Tropicultor operator's manual: field operations. Patancheru, A.P. 502324, India: ICRISAT.

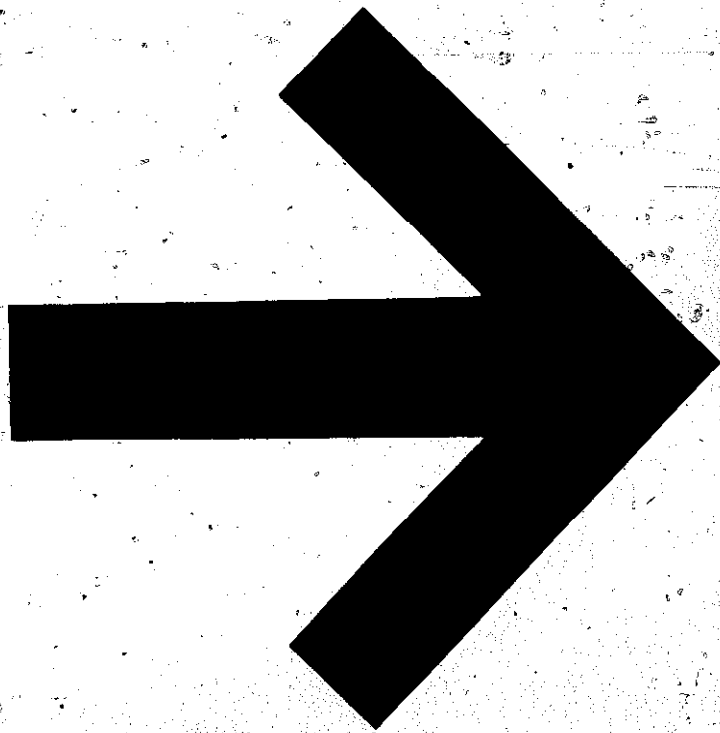

Contents

ASSEMBLY	2
Operations on Flat Land	
PLOWING	
Changing the position of the right wheel	5
Fixing the plow	6
Adjusting the depth	8
Adjusting the width of the cut	8
Adjusting the pitch	9
Operating the plow	10
CULTIVATION	
Cultivation with rigid tines	12
Cultivation with spring tines	13
Cultivation with a blade harrow	15
Cultivation with a disc harrow	16
Operations on Broadbeds	
MAKING BROADBEDS AND FURROWS FOR THE FIRST TIME	17
TILLAGE	
Plowing	21
First pass: furrowing in the center of the broadbed	21
Second pass: plowing at 70-cm spacing	24
Third pass: plowing at 1.10-m spacing	26
Fourth pass: tillage in furrows	27
Cultivation	29
Cultivation with rigid tines	29
Cultivation with spring tines	31
Cultivation with a blade harrow	32
Bed-shaping	33
PLANTING AND FERTILIZER APPLICATION	
Hand-metering System	35
Sowing four rows at 30-cm spacing	35
Sowing an intercrop at 45-cm spacing	39
Four-row Mechanical Planter	42
Mounting the planter on the Tractor	42
Planting four rows at 30-cm spacing	47
Planting an intercrop at 45-cm spacing	53
Clearing the planter	57
INTERROW CULTIVATION	
In a four-row crop spaced at 30 cm	58
In a three-row crop spaced at 45 cm	61
Supplementary Tables	
1. Calibration chart for the fertilizer drill	62
2. Seed metering plate selection chart	62

Assembly

The Tropicultor is normally delivered partially assembled. But the operator should nevertheless take the following steps to check his machine, the component parts of which are shown in Figure 1.

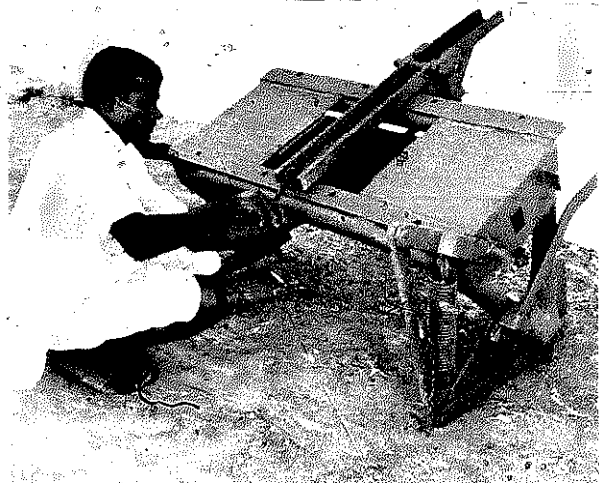

Fit the channel assembly in the center of the frame with two eye bolts.



Fit the beam on the channel assembly ...



... with two bolts.



Carefully tilt the Tropicultor frame so that it rests on the toolbar supports and the beam is vertical.

- 1. FRAME
- 2. CHANNEL ASSEMBLY
- 3. BEAM
- 4. LIFTING HANDLE
- 5. TOOLBAR
- 6. WHEELS
- 7. TIRES
- 8. AXLE
- 9. TOOL BOX
- 10. PITCH SCREW
- 11. TOOLBAR SUPPORT

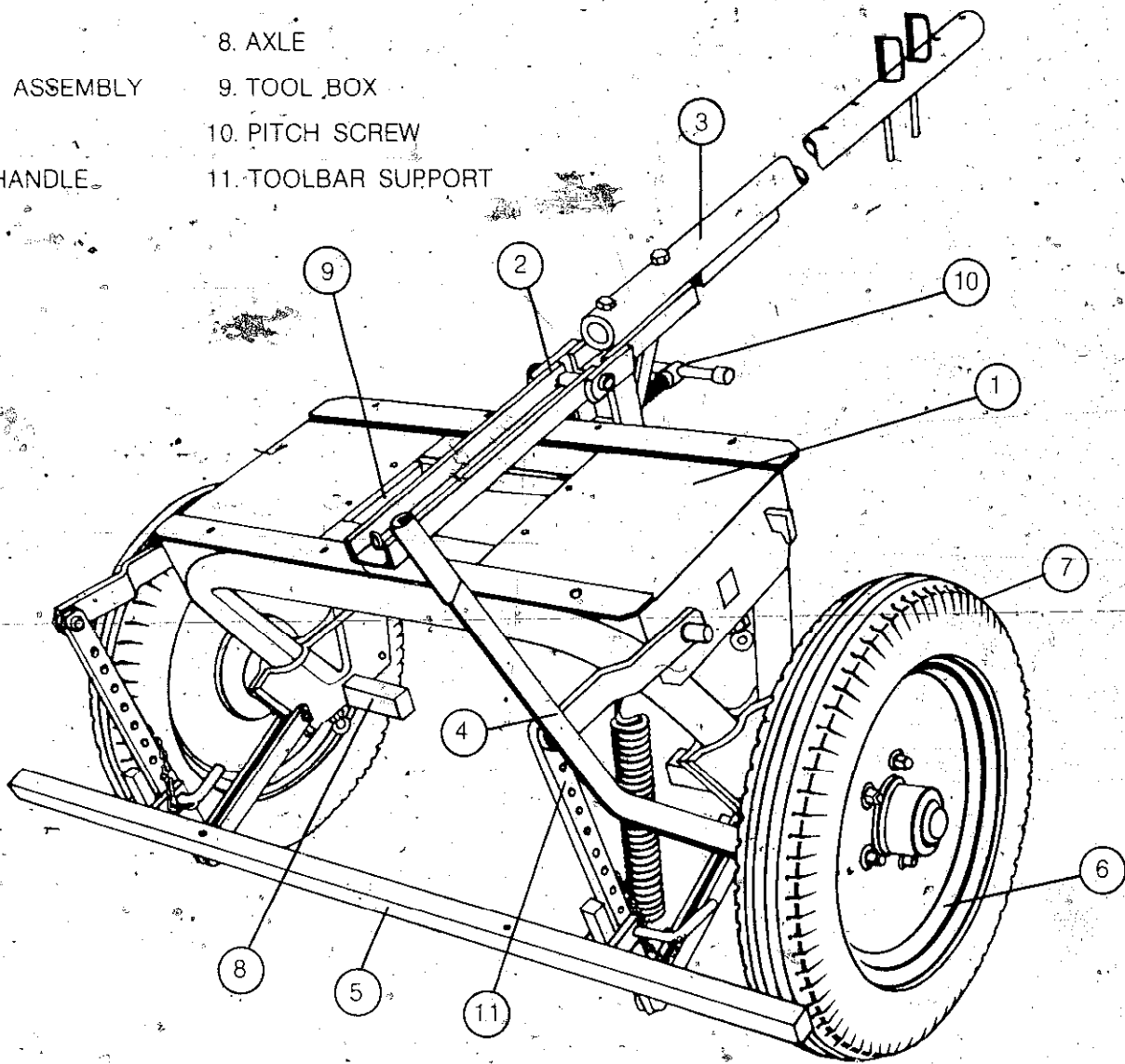
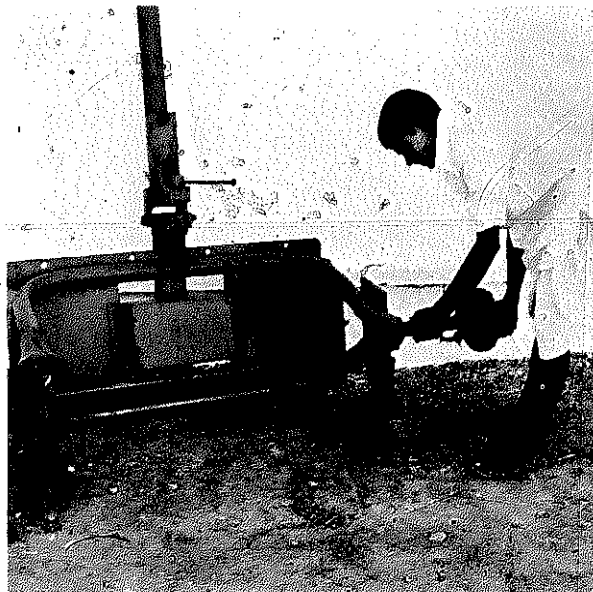

Fig. 1. The major components of the Tropicultor.



Loosen the eye bolts at both sides of the axle housings, and slide in the square axles.



Fill the tires with air up to 2 kg/cm² (28-30 psi).



Bolt the wheels onto the axle flanges.

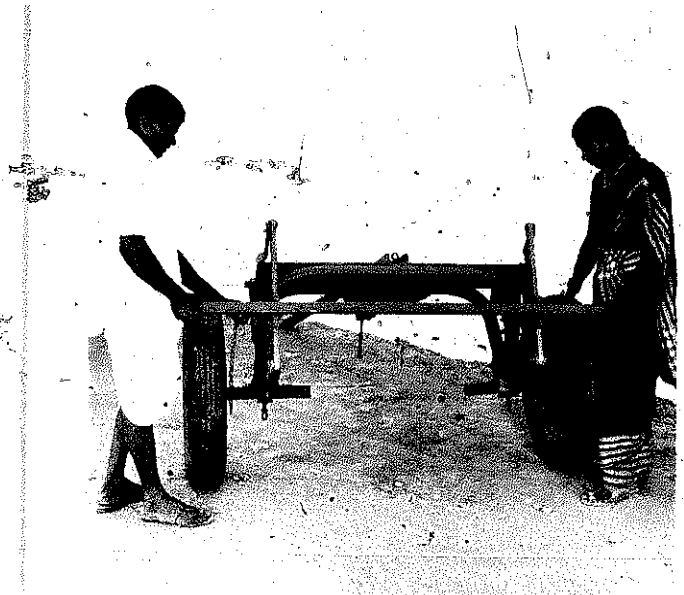

Lower the Tropicultor and fit the toolbar on the toolbar supports ...

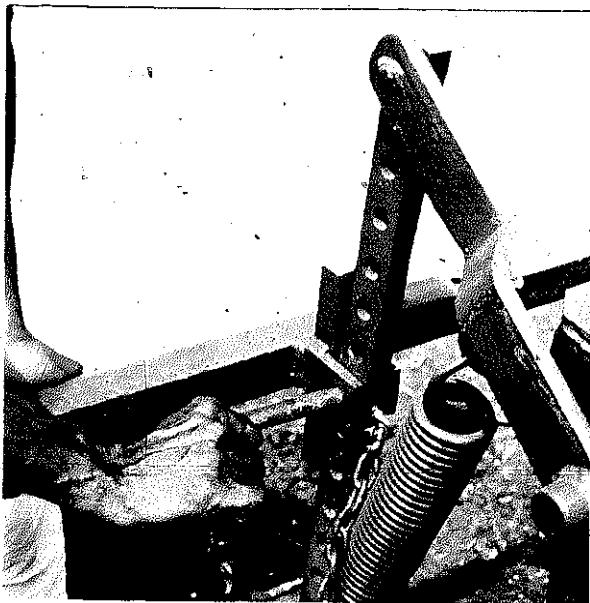

... and insert the two pins.



Check that the lifting handle functions properly in the extreme forward and rear positions: the toolbar should lock firmly in both positions,

Now the Tropicultor is ready for use.

Operations on Flat Land

Plowing

For plowing with a single moldboard plow on flat land, fit the right wheel inside and under the frame as described below.

Changing the position of the right wheel

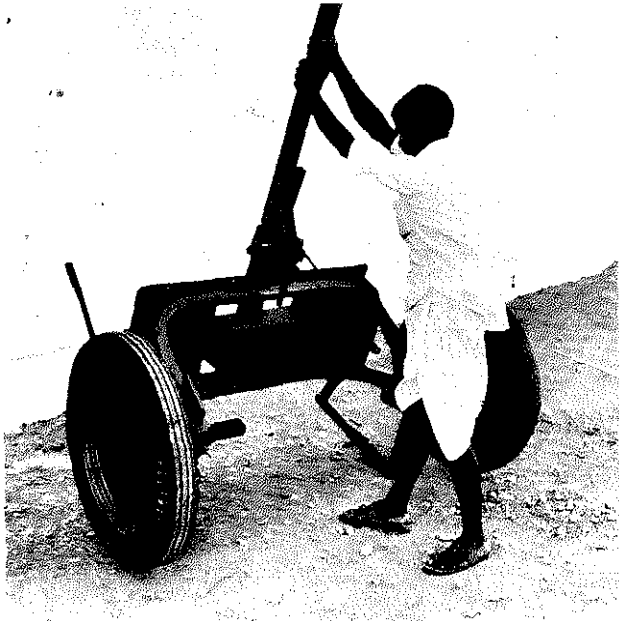

Remove the toolbar and tilt back the Tropicultor.

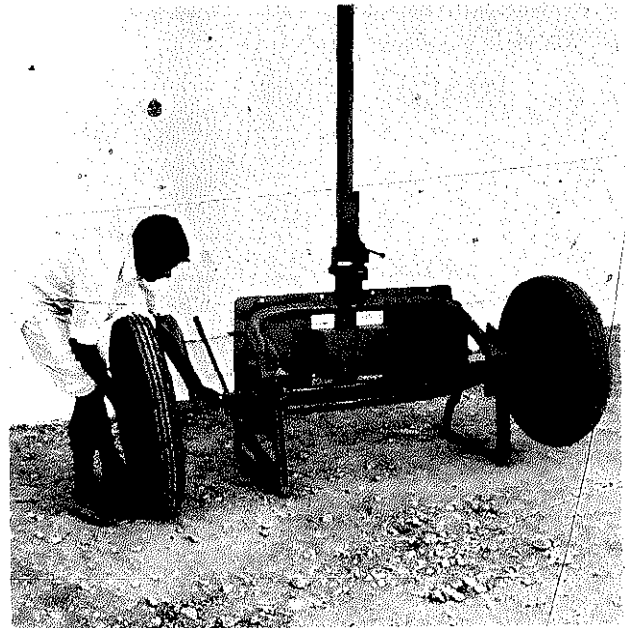

Loosen the right-wheel eye bolt and slide out the axle from its housing.

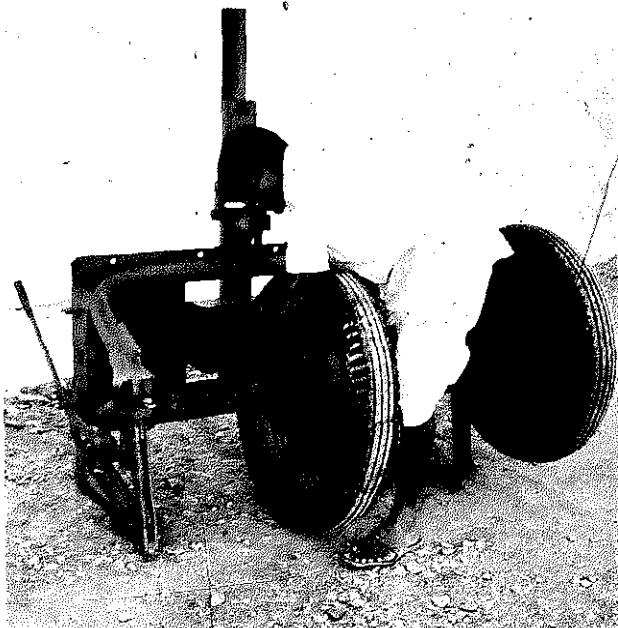

Refit the wheel from inside the frame.

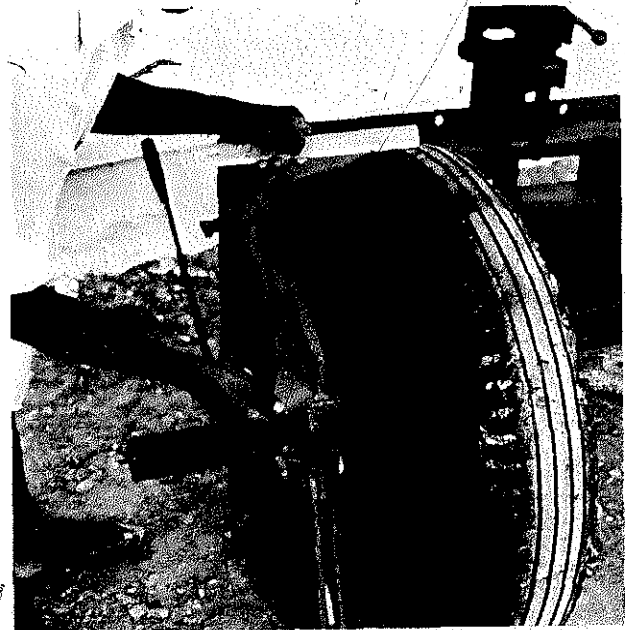

Check and adjust the distance from the center of the tire to the housing: it should be 15 cm approximately. Then tighten the eye bolt.

Fitting the plow

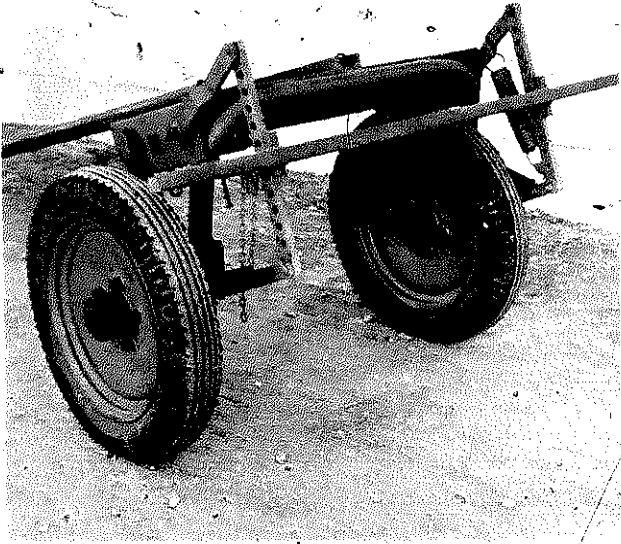

Bring the Tropicultor to the working position and refit the toolbar.

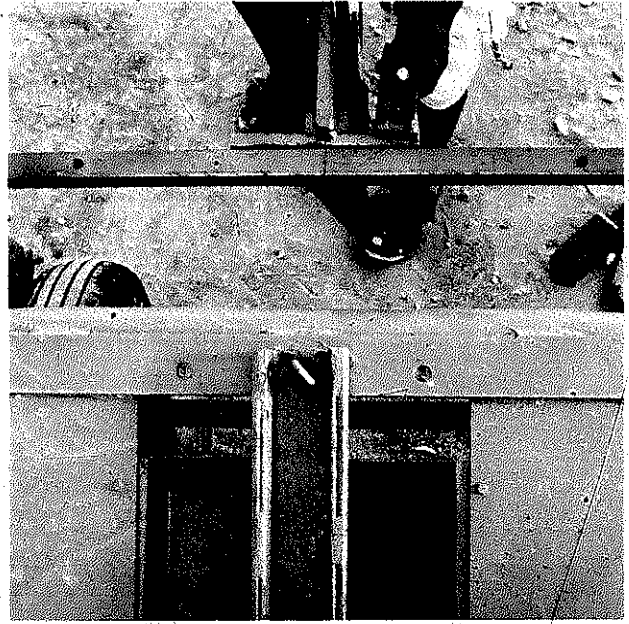

Position the plow standard on the toolbar directly behind the beam.



Slide in the clamps on either side of the plow standard.

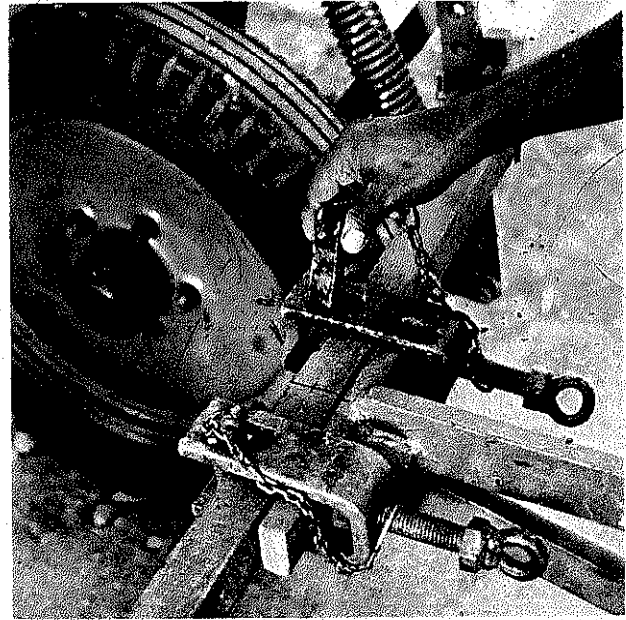

Insert the square pins through the openings provided on the clamps.

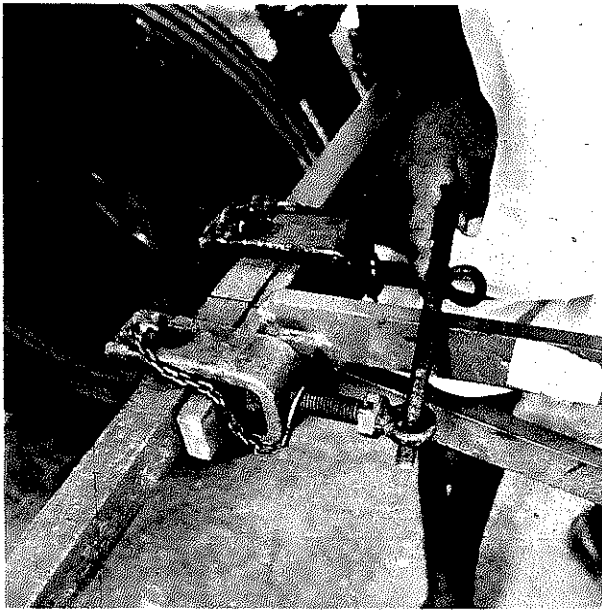

Tighten the clamp eye bolts firmly with a tommy bar.



Hitch the bullocks at about 80 cm spacing, keeping the beam between them.



Start plowing and observe how the plow functions. Make adjustments if necessary, as follows.

Adjusting the depth

Adjust the plowing depth by raising or lowering the toolbar along the toolbar supports.

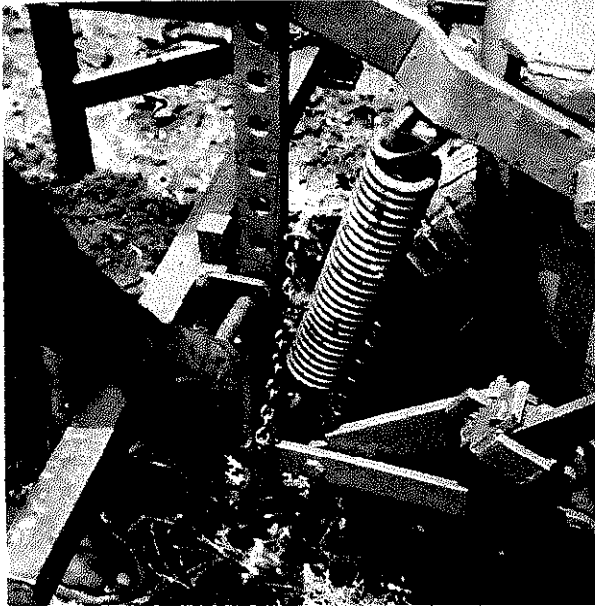

Remove the pins from the toolbar.



Raise or lower the toolbar to the height required and replace the pins.

Adjusting the width of the cut

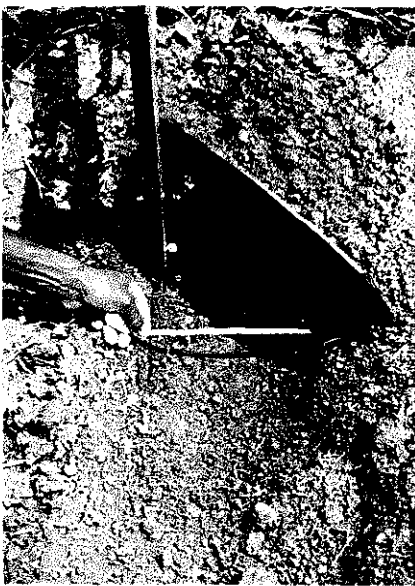

Check the width of the cut.



Loosen the clamp and move the plow slightly to the left to increase the width, or to the right (as shown) to reduce the width.



Tighten the clamps.

Adjusting the pitch

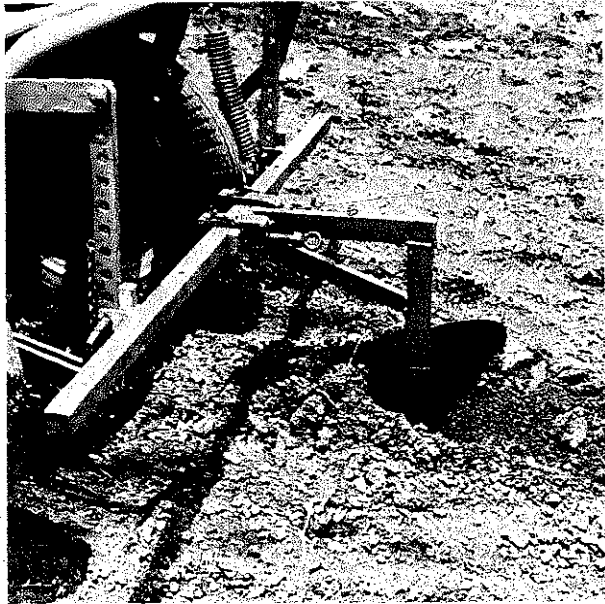

Check if the plow standard is vertical. If it is, no adjustment is necessary.



If the plow standard is not vertical while working, stop the machine and rotate the pitch screw using the attached sliding rod.



Now verify that the plow standard is vertical. Adjust the screw again, if necessary.

Operating the plow



Plow the first pass in a straight line keeping the toolbar level.



At the end of first pass lift the plow fully by pulling the handle before making a turn.



For the second pass position the right wheel and the right bullock in the furrow made earlier and engage the plow.

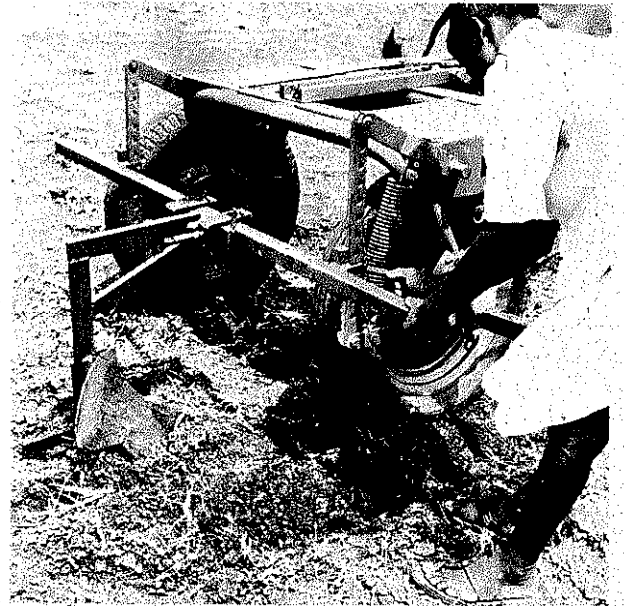

For the third pass lower the toolbar by one hole on the right side.



Make the third pass with the right wheel and right bullock moving on the plowed soil (ridge).



For the fourth and subsequent passes make the toolbar level by raising it one hole at the right toolbar support and lowering it one hole at the left toolbar support. Keep the right wheel and the right bullock in the furrow.

Caution

1. Select the right width and depth for the plow to avoid straining the bullocks.
 2. Never operate the Tropicultor without locking the handle in position.
 3. Never use the pitch screw for depth adjustment.
 4. Plowing when the soil is in a good working condition will require less pull than when the soil is too wet or too dry.
-

Cultivation

For cultivation, the right wheel can be positioned either inside or outside the frame. The inside position is preferable because it avoids overrunning the cultivated soil with a tire. Cultivation can be done using any of the four attachments: rigid tine, spring tine, blade harrow or disc harrow. Rigid and spring tines can be fitted with duckfoot sweeps of 15, 20, or 25 cm width as desired.

Cultivation with rigid tines

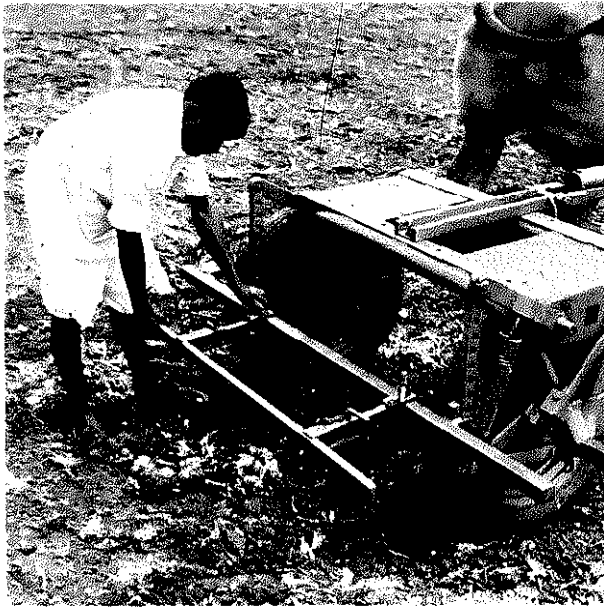

Fit the steerable toolbar to the main toolbar and insert the locking pins.

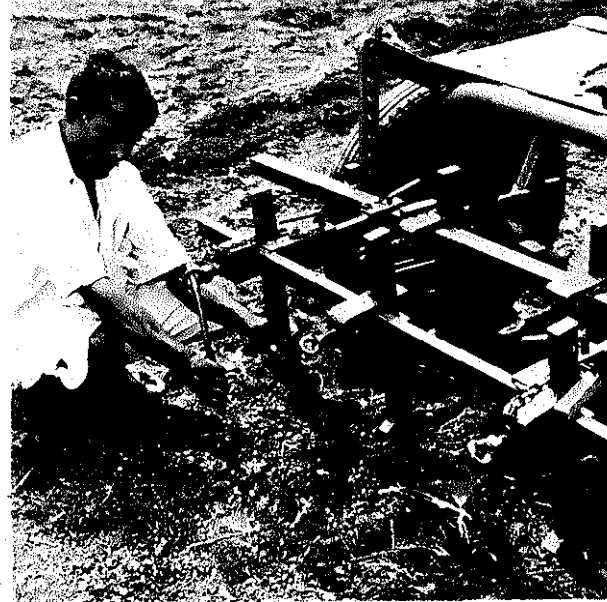

Fit two tines on the main toolbar and three tines on the steerable toolbar, alternately. See Figure 2.

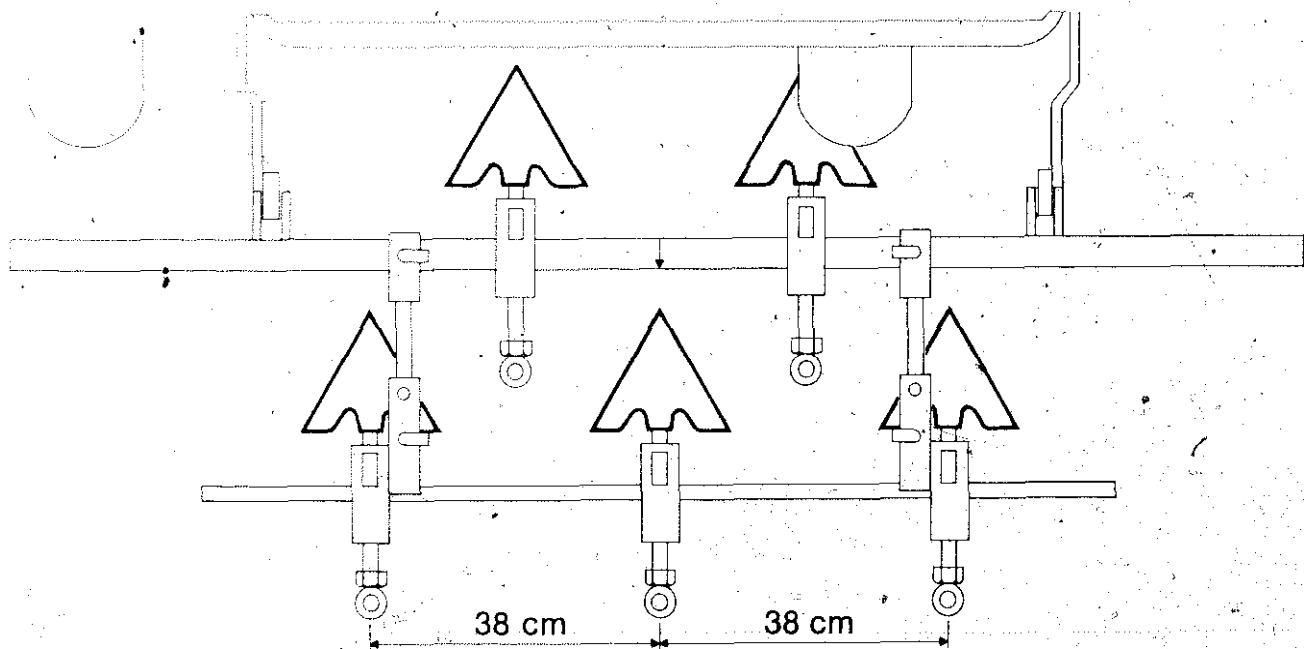
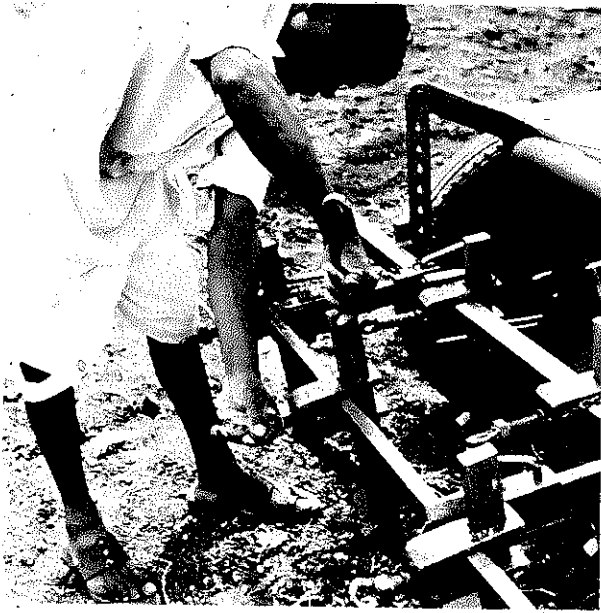

Fig. 2. Mounting positions for the rigid tines.



Measure the height of projection above the clamp and make it equal for all the tines. Adjust the distance between the center of the tines as shown in Figure 2.



Start cultivating from one end of the field and observe the depth of working.

Cultivation with spring tines

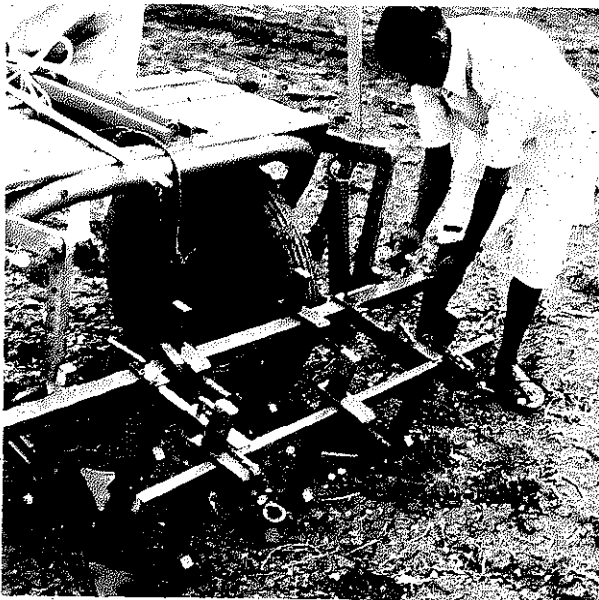

If necessary, adjust the depth by changing the toolbar height.

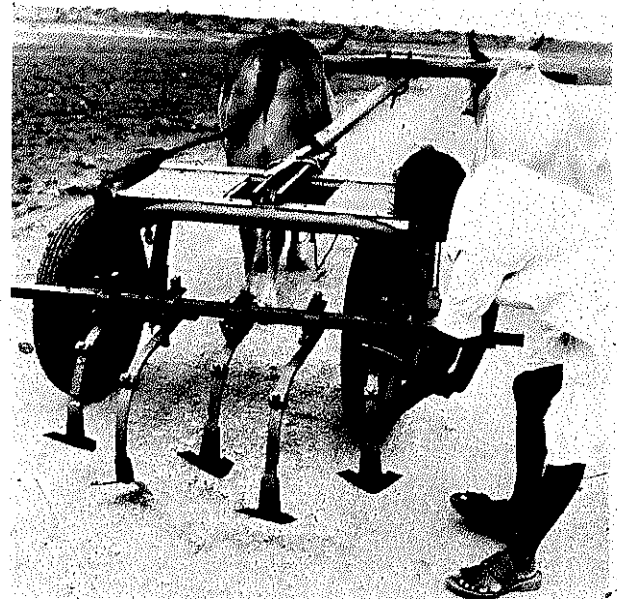

Fit two long and three short spring tines on the toolbar alternately. Adjust the space between the center of the tines as shown in Figure 3.



Start cultivation from one end of the field and observe the depth of working.



Adjust the depth if necessary by changing the toolbar height.

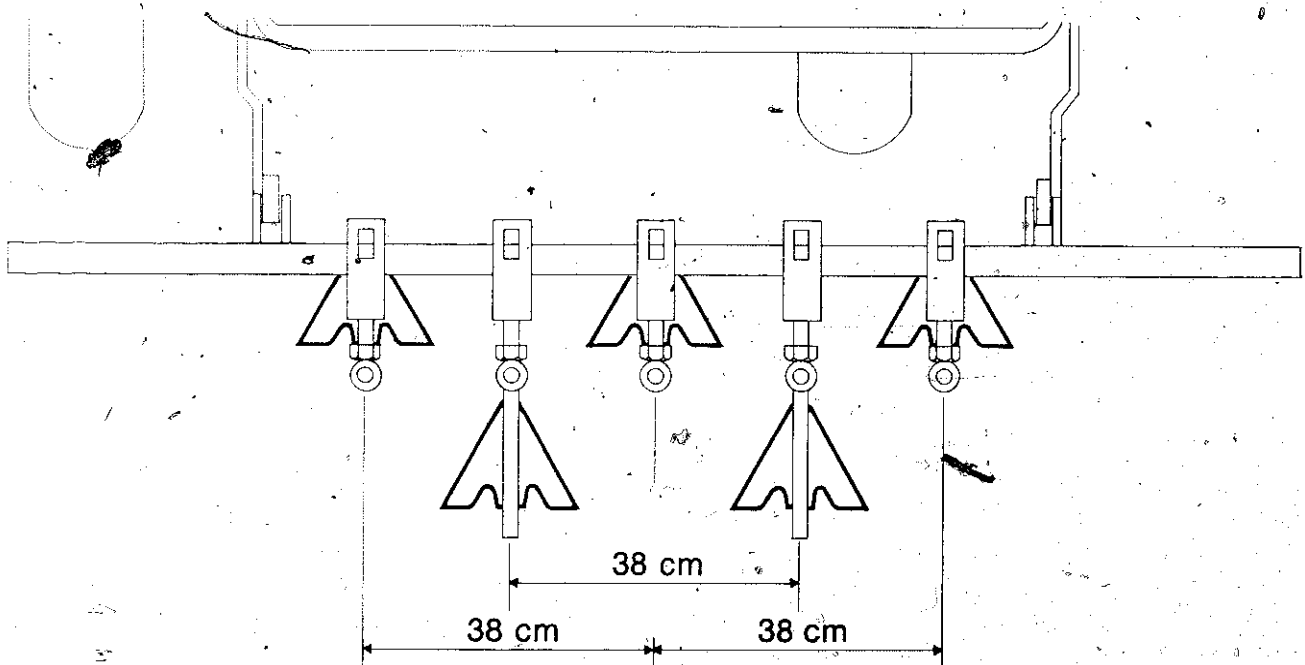

Fig. 3: Mounting positions for the spring tines.

Cultivation with a blade harrow



Fit a 1.2-m wide blade harrow on the toolbar centrally behind the beam, using two clamps.



Start cultivation from one end of the field and observe the depth of working.



Adjust the depth, if necessary, by changing the toolbar height ...



... or by adjusting the height of the blade. Ensure that the blade is working at equal depth at both ends.

Cultivation with a disc harrow

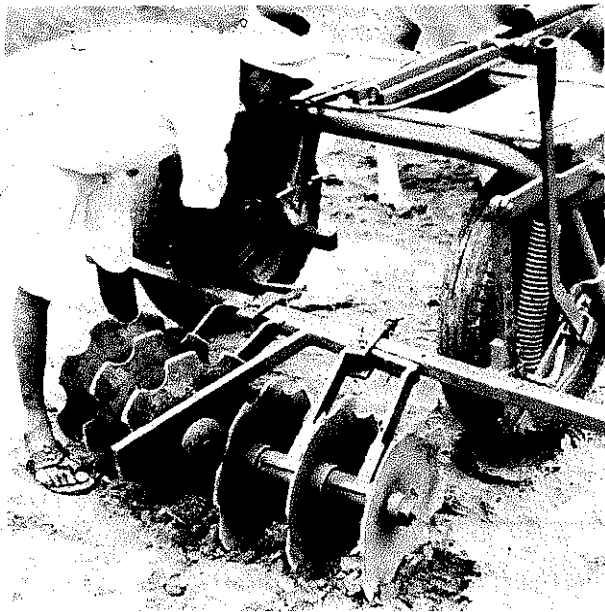

Mount the disc harrow on the toolbar with its center in line with the beam.



Fit one rigid cultivator tine to the middle extension on the disc harrow.

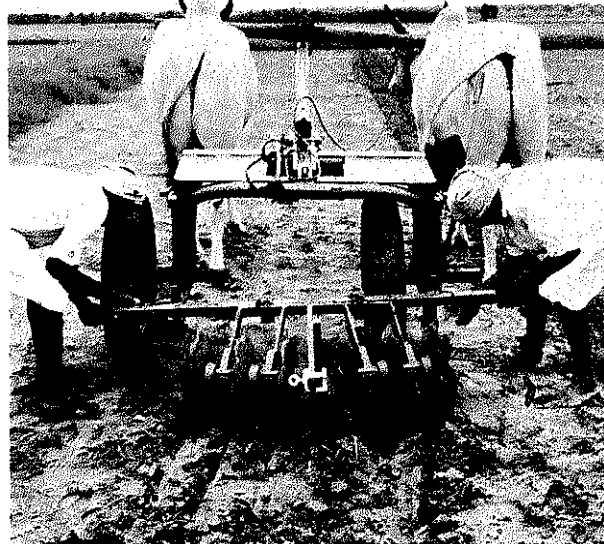

If necessary, adjust the depth by changing the toolbar height.

Operations on Broadbeds

Making Broadbeds and Furrows for the First Time

The broadbed-and-furrow (BBF) system of cultivation is especially suitable for Vertisols (deep black soils). To make broadbeds for the first time it is necessary to contour-survey the field and identify the direction of slope. Prepare a contour map and draw a key line representing the desired slope, starting from one end of the field.



Make the key line in the field with pegs (or with lime).

In the BBF system crops are grown on broad seedbeds separated by furrows made at a regular spacing of 1.5 m and at a slope of 0.4 to 0.8%. The furrows assist drainage and provide a track for the movement of the bullocks and the wheels of the Tropicultor.

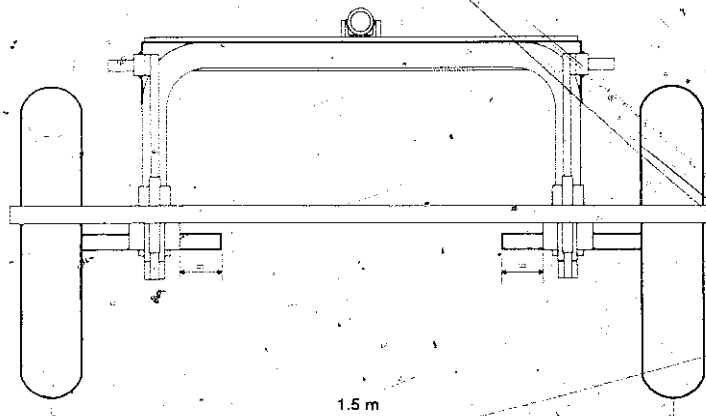

Before starting work with the Tropicultor, ensure that the wheels are fitted on the outside of the frame at a wheel track of 1.5 m, and that the axle projections are equal on both sides (see Fig. 4). Hitch two bullocks also 1.5 m apart.

Fig. 4. Rear diagram of the Tropicultor with a wheel track of 1.5 m.

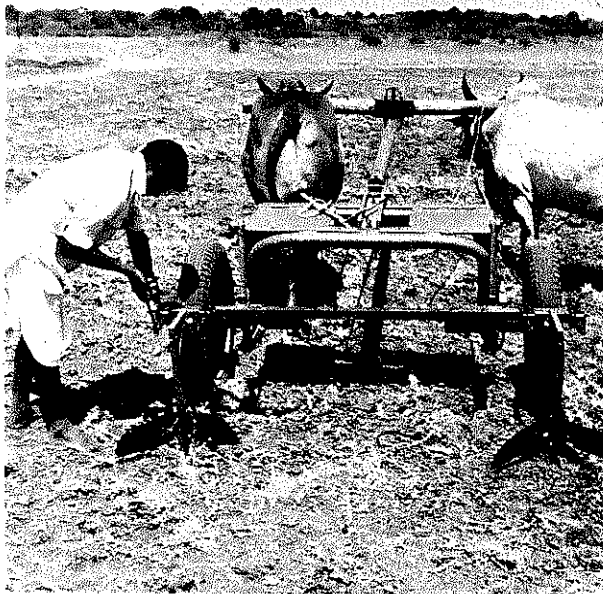

Fit two ridders on the toolbar, one behind each wheel.



Check the distance of each ridger from the center of the toolbar and adjust if necessary to make it 75 cm.



Take the Tropicultor to one end of the field.



Lower the toolbar by pushing the handle backwards into a fully locked position and move for some distance parallel to the key line.



Adjust the depth of working if necessary by changing the toolbar height.



Start moving again and check that the rigger standards are vertical. If not, as shown here, ...



... make them vertical by turning the pitch adjustment screw.



Finish making the first two furrows. At the end of the field, lift the toolbar and make a turn.



Position one wheel and one bullock in the previous furrow.



Lower the toolbar and start moving, keeping one wheel and one bullock in the previous furrow.

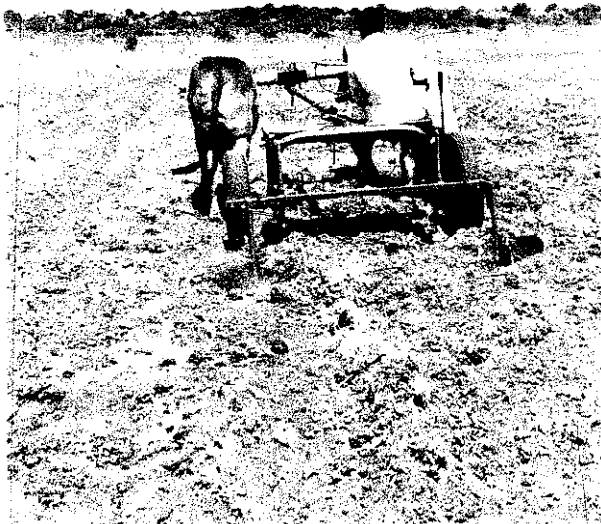

At the end of the second pass make a turn and position one side wheel in the third furrow. Complete making furrows at 1.5-m intervals over the field, as required.

Caution

1. In the first pass be careful to follow the key line.
2. Work at shallow depth so that the bullocks may walk in a straight line without strain.
3. Always make turns outside the field or in the waterway and lift the implement fully before turning.
4. Never operate the Tropicultor without locking the handle in position.

Tillage

Plowing

Primary tillage on existing broadbeds is done in four passes.

First pass: furrowing in the center of the broadbed

Ensure that the wheels are fitted outside the Tropicultor frame at a wheel track of 1.5 m, as shown in Figure 4. Then fit one ridger at the center of the toolbar as shown in Figure 5.

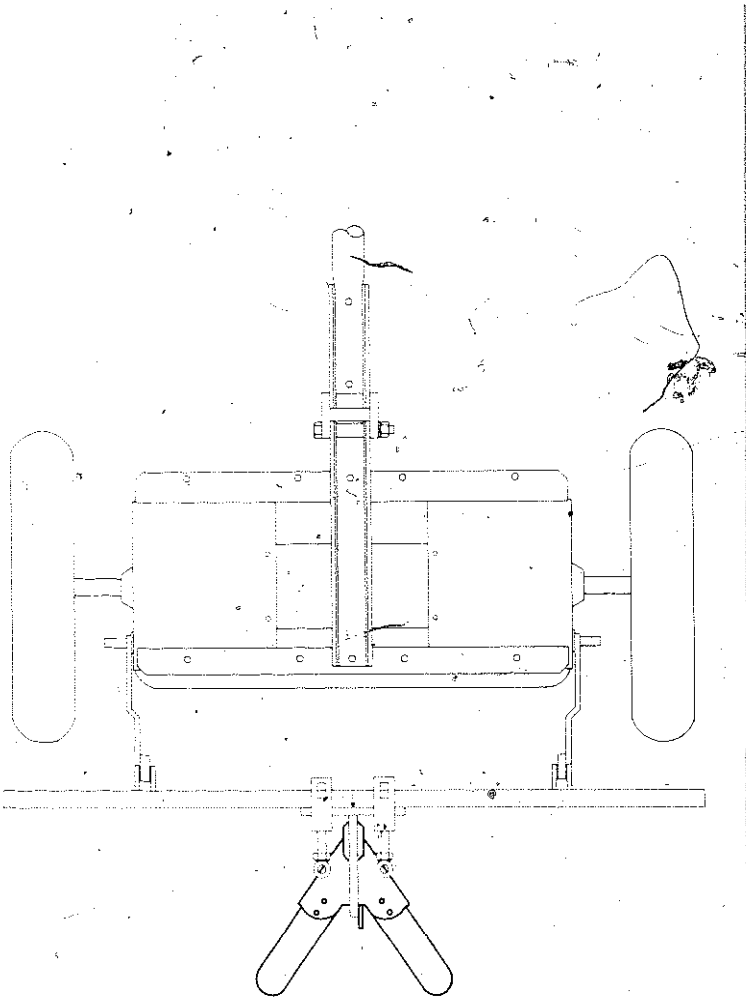

Fig. 5. Mounting position of a ridger.



Take the Tropicultor to one end of the field and position the wheels in the furrows.



Lower the toolbar by pushing the handle backwards fully, and start moving.



After moving about 5 m check the depth of working.



Adjust the depth if necessary by changing the toolbar height.



Start moving again and check if the ridger standard is vertical. If it is not, as shown here,



... make it vertical by turning the pitch adjustment screw.



Go up to the end of the field and lift the toolbar.



Make a turn and position the Tropicultor over the third bed.



Lower the toolbar and complete furrowing in the center of the broadbed throughout the field.

Second pass: plowing at 70-cm spacing between right- and left-hand moldboard plows



Remove the ridge from the toolbar center.



Attach one rectangular extension with two clamps to the right side of the toolbar at 20 cm from the center (see Fig. 6).

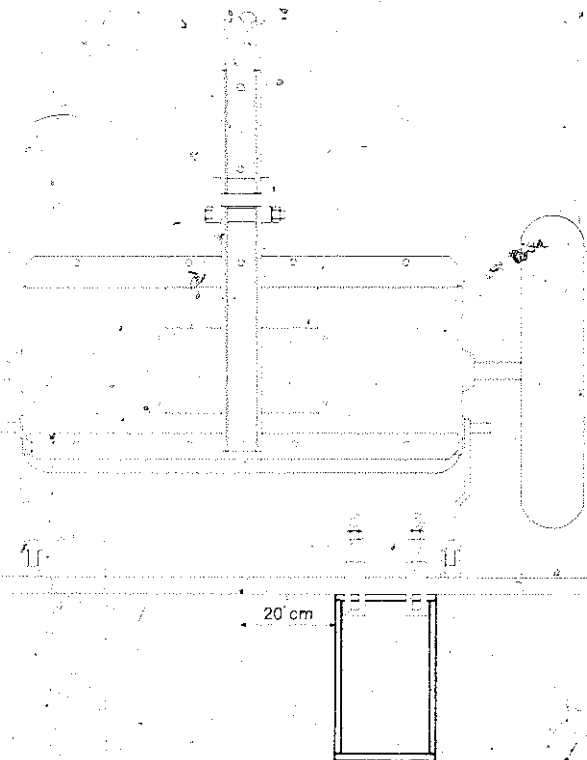

Fig. 6. Mounting position for the rectangular extension.



Fit one right-hand plow on the toolbar at 35 cm from the center. And then fit one left-hand plow to the rectangular extension at 35 cm from the center of the toolbar (see Fig. 7). Tighten all the clamps firmly.

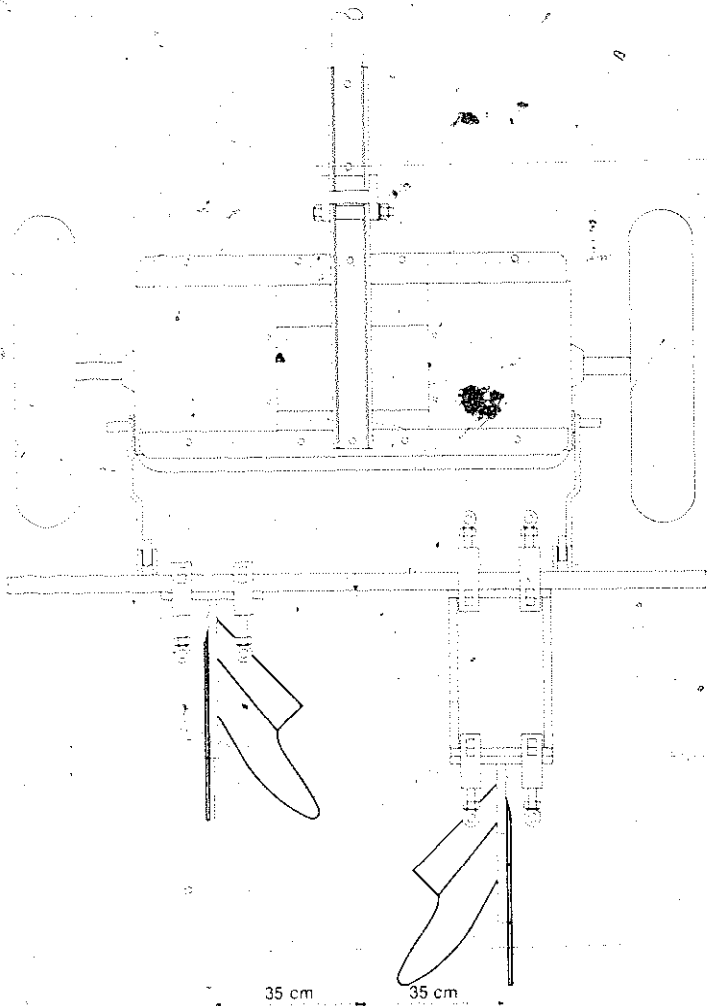

Fig. 7. Mounting positions for the right- and left-hand plows.



Take the Tropicultor to one end of the same field and position the wheels in the furrows.



Lower the toolbar by pushing the handle backwards fully, start moving, and observe the depth of working.



Adjust the depth of working if necessary by changing the toolbar height.



Adjust the pitch screw if the plow standards are not vertical.



Complete plowing the entire field.

Third pass: plowing at 1.1-m spacing

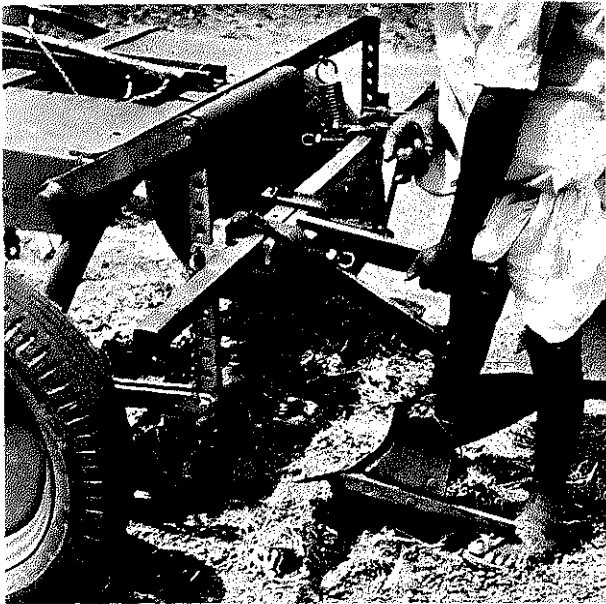

Remove the plows from the toolbar.



Refit the plows at 55 cm from the center.



Take the Tropicultor to one end of the same field and start plowing.



Complete plowing the entire field following the procedure described for the second pass.

Fourth pass: tillage in furrows

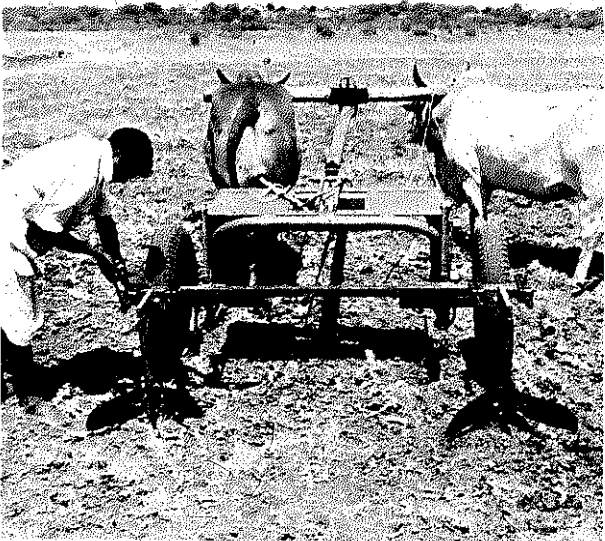

Remove the plows from the toolbar, and fit one ridger behind each wheel.



Check the distance of each ridger from the toolbar center. It should be 75 cm.



Take the Tropicultor to one end of the same field and start working. Then complete furrowing the entire field following the same procedure as given for the first pass.

Caution

1. Make the turn outside the field or in the waterway and lift the implement fully before turning.
 2. Drive the bullocks carefully so that they walk in the furrows and not on the adjacent broadbeds.
 3. Adjust the depth of working properly to avoid straining the bullocks.
 4. Never operate the Tropicultor without locking the handle in position.
-

Cultivation

Cultivation for secondary tillage on broadbeds can be done with rigid tines, or spring tines fitted with 20-cm wide sweeps, or a 1.2-m wide blade harrow depending upon the condition of the soil. In normal conditions use of the rigid tines and the blade harrow is recommended.

Cultivation with rigid tines

Before starting work with the Tropicultor, ensure that the wheels are fitted from outside the frame at a wheel track of 1.5 m and that the axle projections are equal on both sides, as shown in Figure 4.

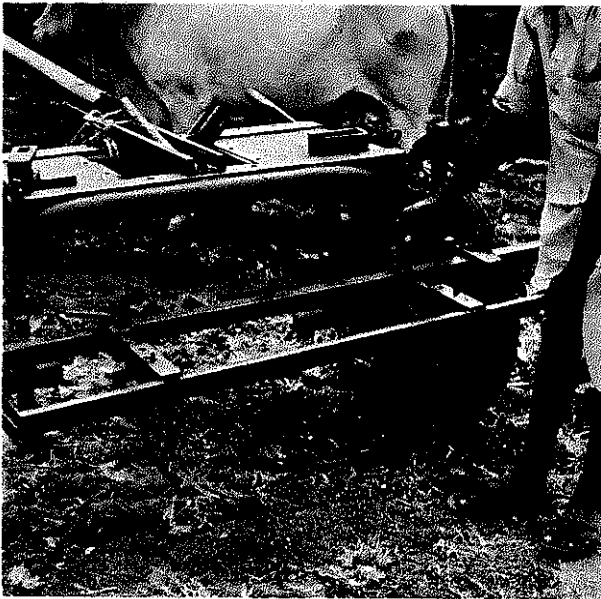

Fit a steerable toolbar on the main toolbar.

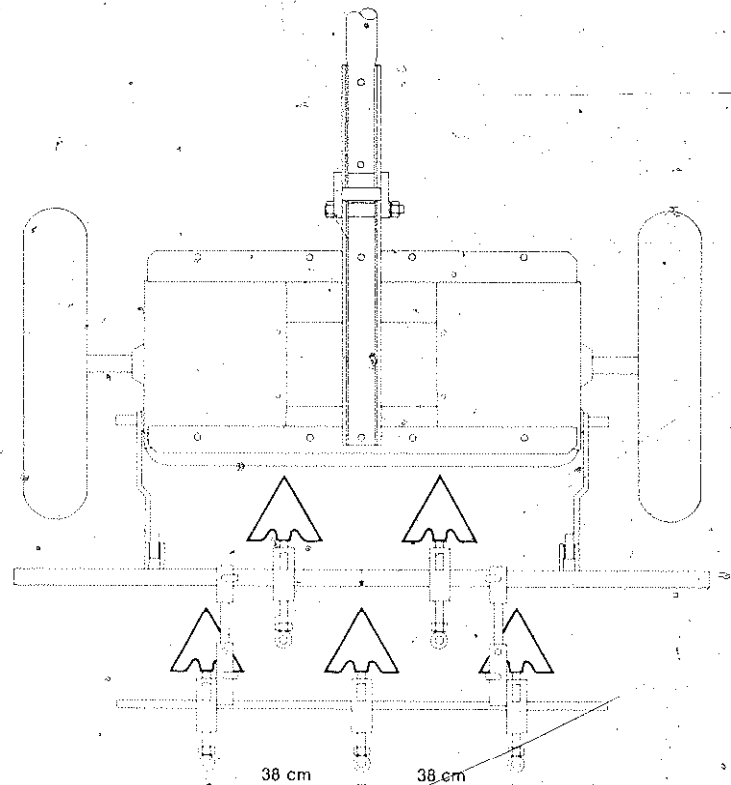

Fig. 8. Mounting positions for five rigid tines.

Insert both side pins of the steerable toolbar so that it is in the locked position. Then, as shown in Figure 8, fit three rigid tines on the steerable toolbar and two on the main toolbar and set the distance between the tines to 19 cm.



Measure the height of the projection and make it equal for all the tines.



Take the Tropicultor to one end of the field, position the wheels in the furrows, and start working.



Adjust the depth if necessary by changing the toolbar height or by sliding the tines in the clamps. Then complete cultivating the entire field.

Cultivation with spring tines

Fit two long and three short spring tines on the toolbar and check the distance between them, as shown in Figure 9.

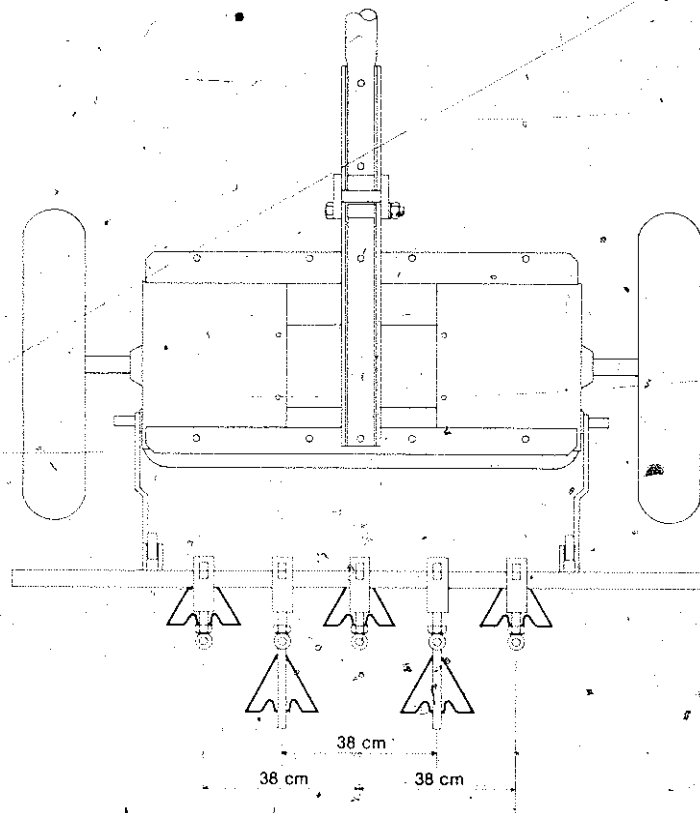

Fig. 9. Mounting position for five spring tines.



Take the Tropicultor to one end of the field and position the wheels in the furrows, and start working.



Observe the depth of working and adjust if necessary by changing the toolbar height. Then complete cultivating the entire field.

Cultivation with a blade harrow

Fit a 1.2-m wide blade harrow and two ridgers; one behind each wheel as shown in Figure 10.

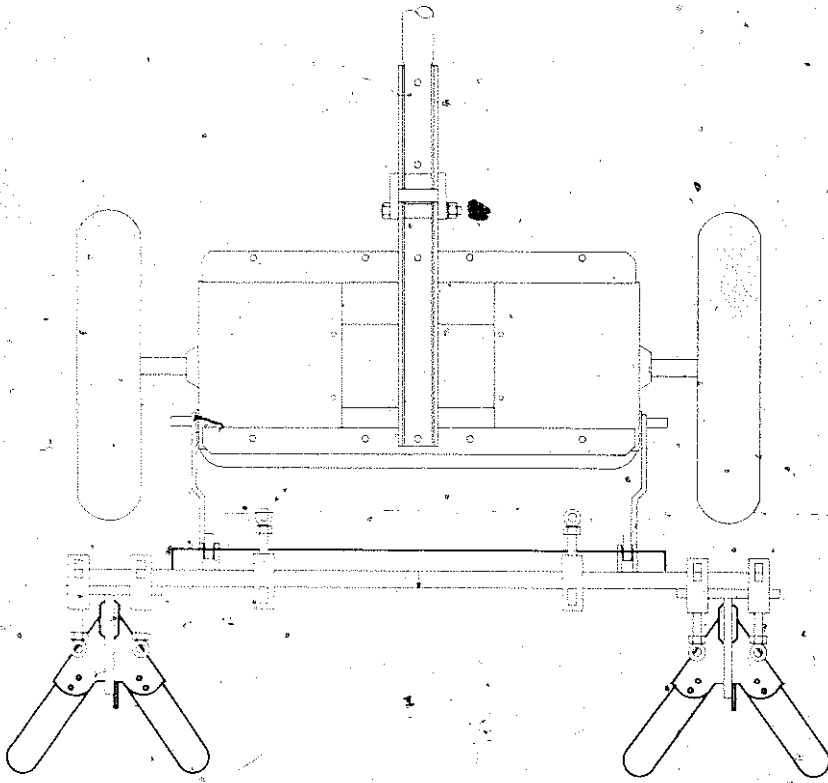

Take the Tropicultor to one end of the field and position the wheels in the furrows, and start working.

Fig. 10. Mounting position for a blade harrow and two ridgers.



Check the depth of working and adjust if necessary.



Complete cultivating the entire field with the blade harrow.

Caution

1. Make the turn outside the field or in the waterway and lift the implement fully before turning.
 2. Drive the bullocks carefully so that they walk in the furrows and not on the adjacent broadbeds.
 3. Never operate the Tropicultor without locking the handle in position.
 4. Tighten the clamps occasionally while working.
-

Bed-shaping

Bed-shaping is the final operation for seedbed preparation, to be done as follows.

Ensure that the wheels are fitted from outside the Tropicultor frame at a wheel track of 1.5 m, as shown in Figure 4. Then fit a 1.2-m wide blade harrow and two ridgers, one behind each wheel, as shown in Figure 10.



Fit a 2-m long and heavy link chain, by inserting the hooks to the third hole from the bottom on the ridger back plate.



Take the Tropicultor to one end of the field and position the wheels in the furrows, and start working.

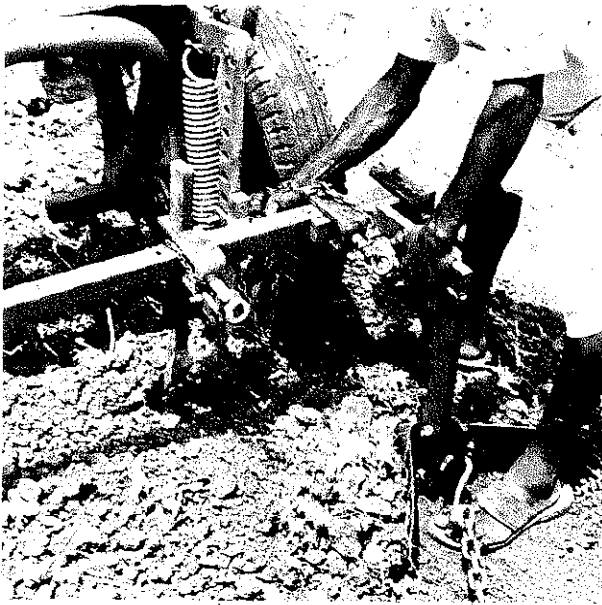

Adjust the depth of working if necessary by changing the toolbar height



Start working again and observe the soil movement on the broadbed.



To increase the soil movement lower both side hooks by one or two holes on the ridger back plate. To reduce the soil movement raise them up. Continue working and complete bed-shaping, the entire field.

Caution

1. Make the turn outside the field or in the waterway and lift the implement fully before turning.
2. Drive the bullocks carefully so that they walk in the furrows and not on the adjacent broadbeds.
3. Never operate the Tropicultor without locking the handle in position.

Planting and Fertilizer Application

The Tropicultor can be used for applying fertilizer and sowing a maximum of four rows at a time by attaching either the hand-metering equipment or the four-row mechanical planter. Both have a facility for applying fertilizer with the seed. Fertilizer is placed 4 cm below and to the side of the seed when a double-shoe furrow opener is used. You can sow a sole crop or an intercrop at required row spacings. However, most convenient spacings are 30 cm (12 in), 45 cm (18 in), 60 cm (24 in), 75 cm (30 in), and 90 cm (36 in). This manual explains how to sow a sole crop at 30-cm spacing, and an intercrop at 45-cm spacing, with a hand-metering system as well as a mechanical planter.

Hand-metering System

Sowing four rows at 30-cm spacing

Ensure that the wheels are fitted from outside the Tropicultor frame at a wheel track of 1.5 m, as shown in Figure 4.

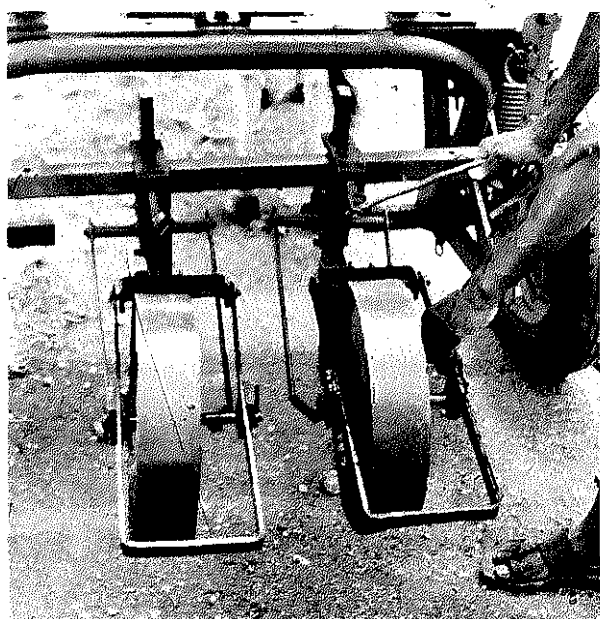

Fit two double-shoe furrow openers with rear shoes spaced at 15 cm from the center of the toolbar.

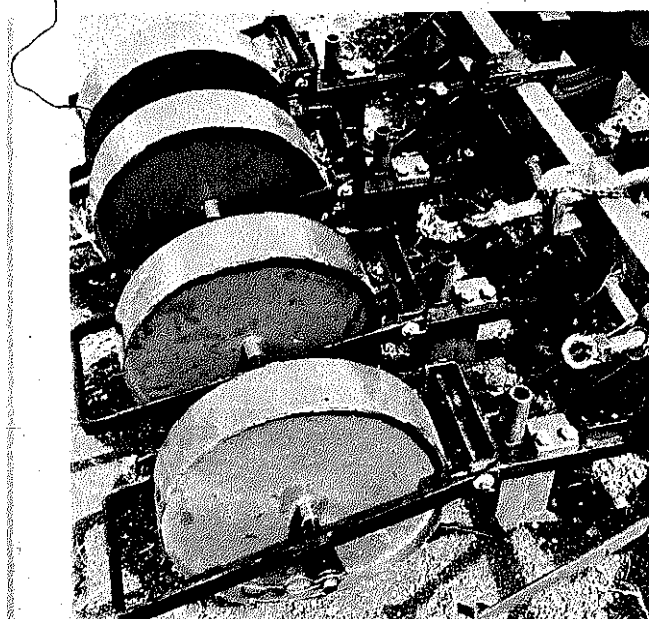

Fit the other two double-shoe furrow openers at 30 cm from the two center furrow openers.

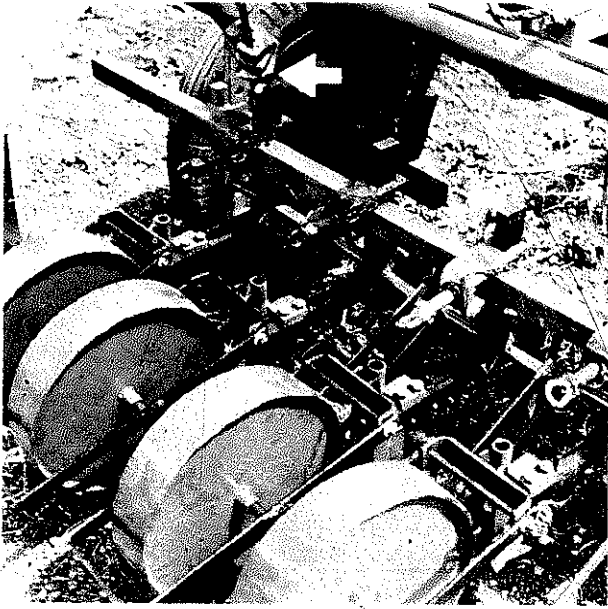

Check the height of the furrow openers by measuring their projection above the clamps. The height should be equal in all cases.

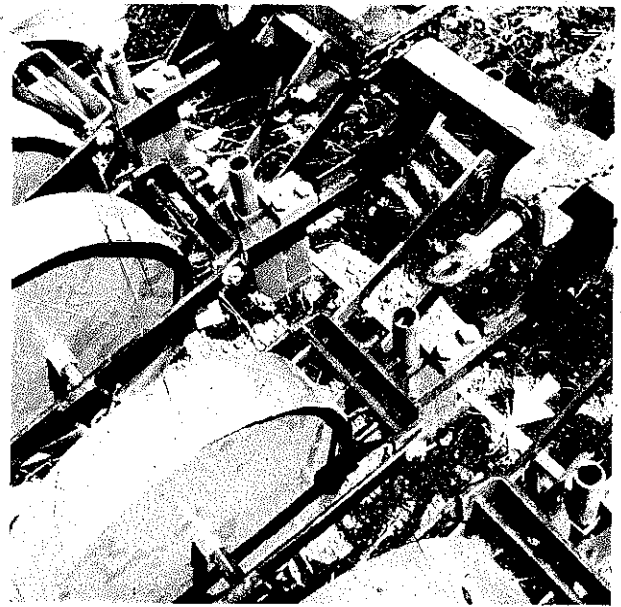

Check with a measuring tape that the distance between the furrow opener rear shoes is 30 cm in each case.

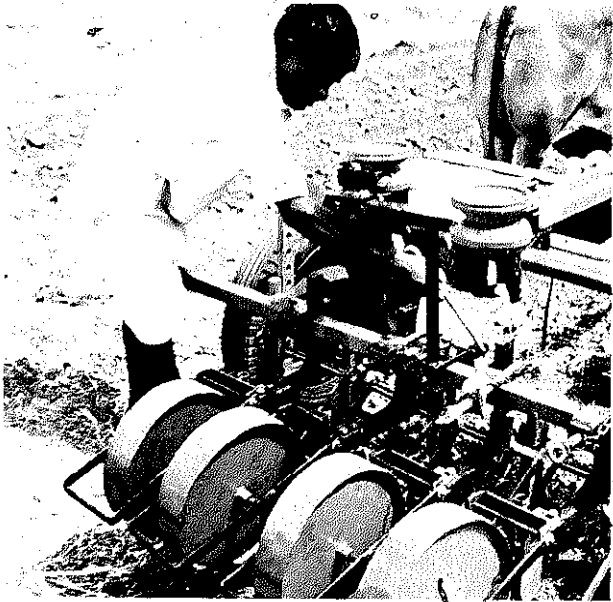

Fit a stand with four-row wooden bowls using one clamp at the center of the toolbar.

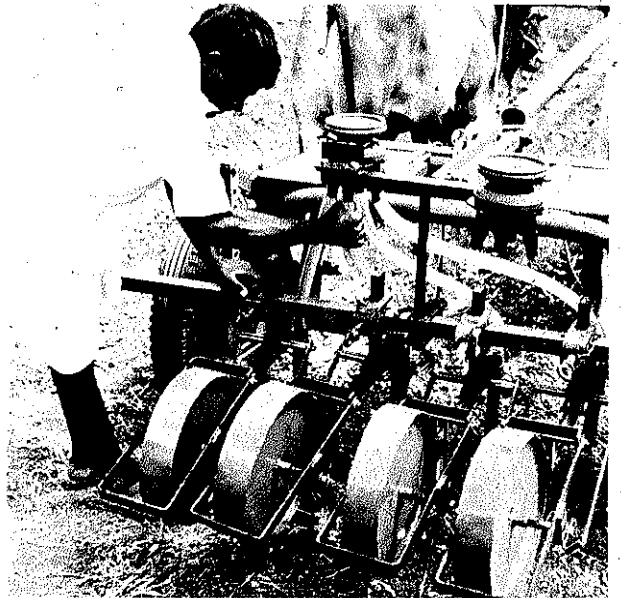

Attach four plastic transparent (or telescopic) tubes from underneath the front bowl to all four front shoes of the furrow openers.

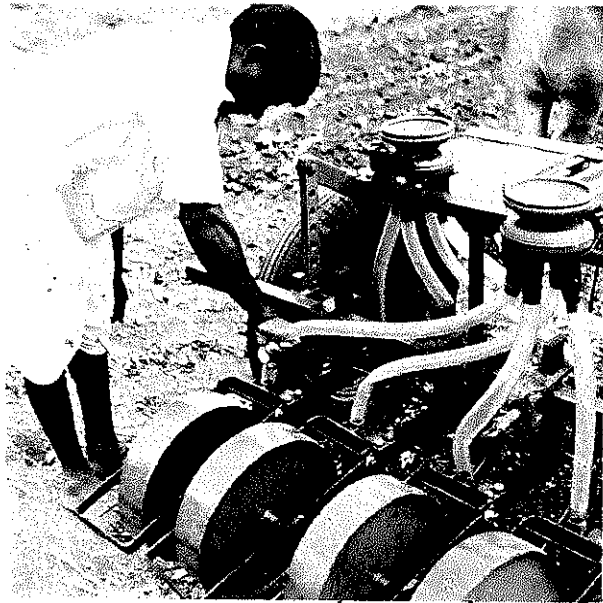

Attach four plastic transparent (or telescopic) tubes from underneath the rear bowl to all four rear shoes of the furrôw openers.

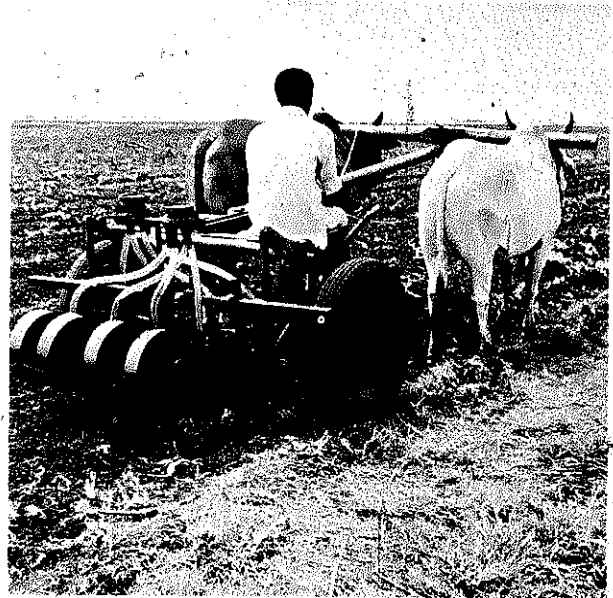

Take the Tropicultor to one end of the field and position the wheels in the furrows.



One person, in addition to the operator, is required to sit on the Tropicultor facing rearwards to drop the fertilizer by hand into the front bowl.

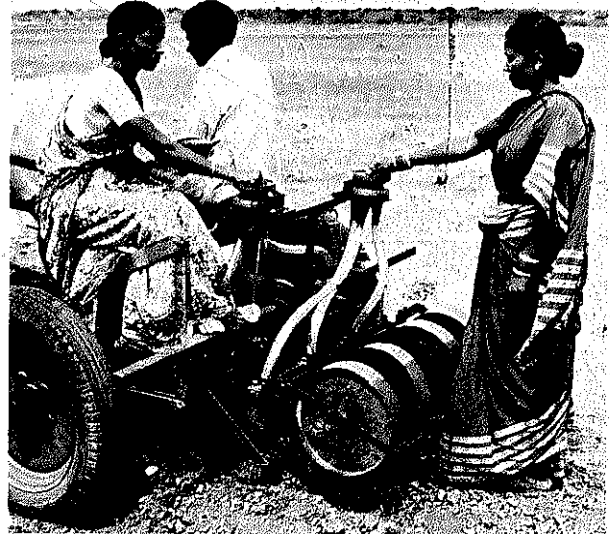

A second person is required to walk behind the machine and drop seed by hand into the rear bowl.

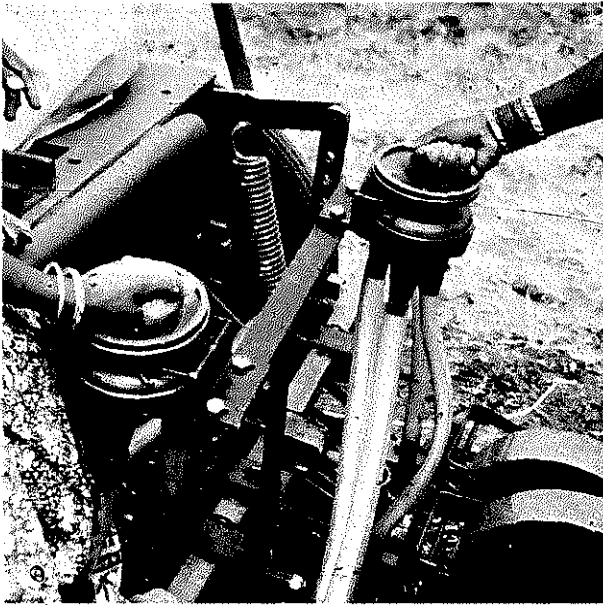

Lower the toolbar by pushing the handle backwards fully, and start moving. Then begin dropping the seed and the fertilizer by hand.

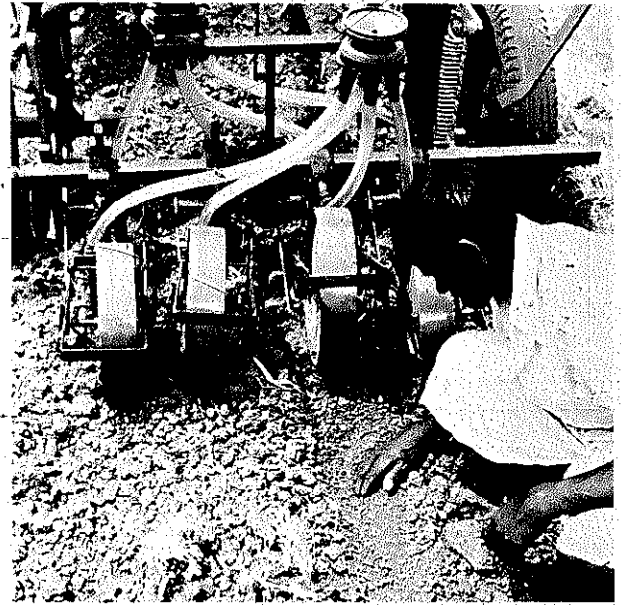

After going 4-5 m, stop the machine and check the depth of seed placement by carefully removing the soil from the seed rows for all four lines.

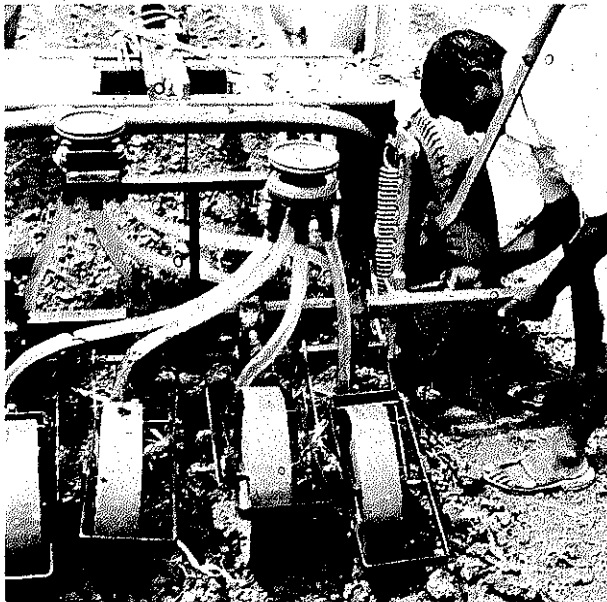

If necessary adjust the depth of seed placement, either by changing the toolbar height ...



... or by varying the height of individual furrow openers. Tighten the clamps and start working again. Then check the depth of seed placement, and adjust if necessary. Continue sowing until the field is sown.

Sowing an intercrop at 45-cm spacing (for example, two rows of cereal and one row of pigeonpea)

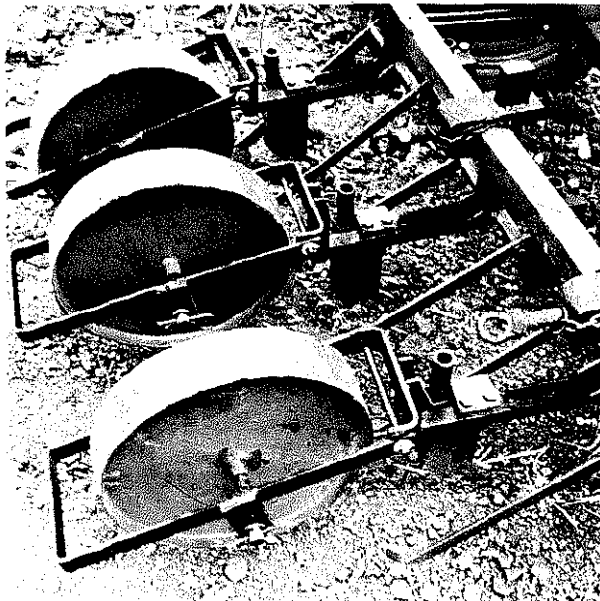

Fit one double-shoe furrow opener at the center of the toolbar and the other two furrow openers at 45-cm from the center.

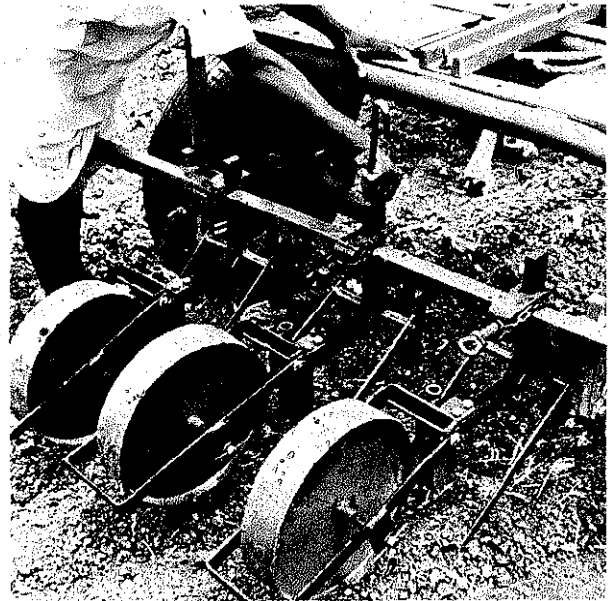

Check the height of the furrow openers by measuring their projection above the clamps. The height should be equal in all cases.

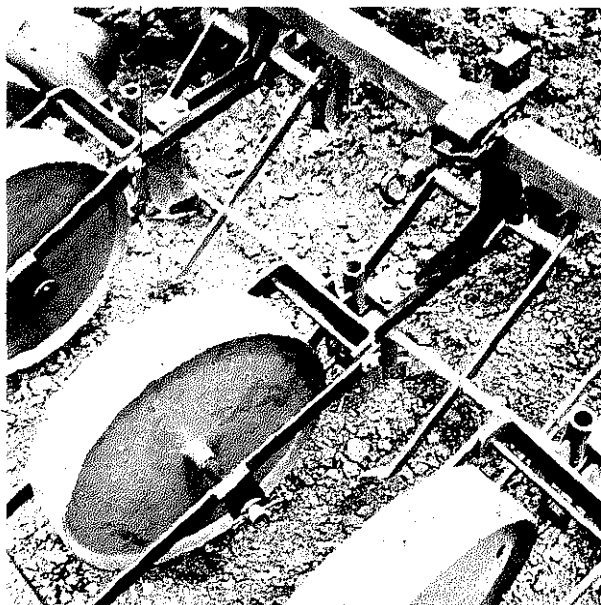

Check with a measuring tape that the distance between the furrow opener rear shoes is 45-cm in each case.

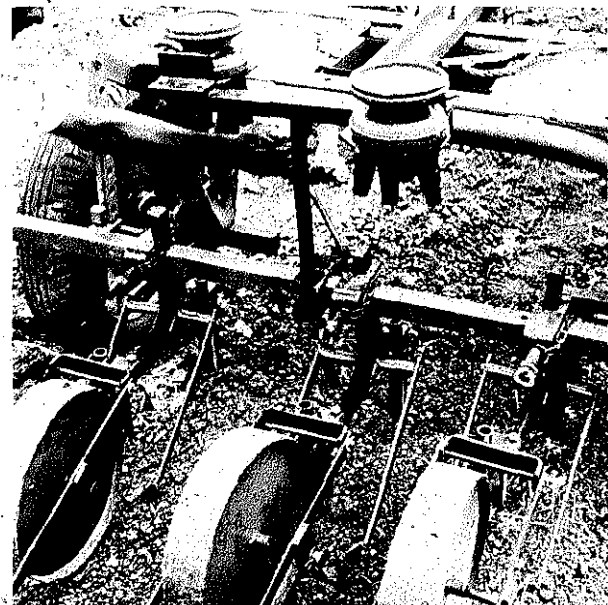

Fit a stand with wooden bowls using one clamp close to the center of the toolbar.

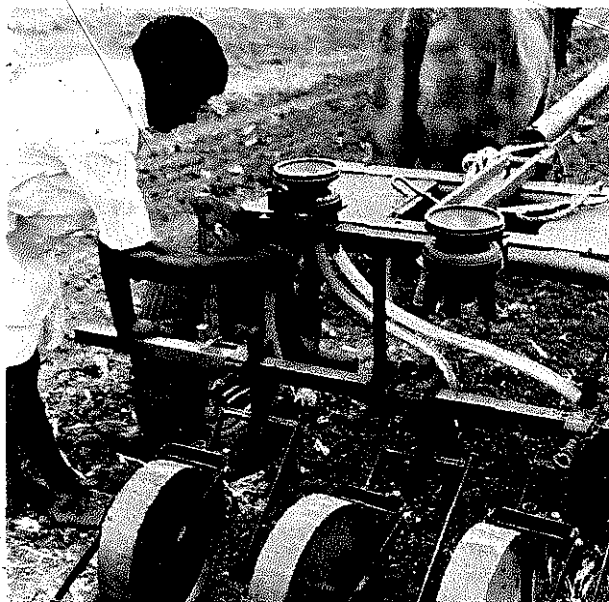

Attach three plastic transparent (or telescopic) tubes from underneath the front bowl to all three front shoes of the furrow openers. Block the fourth hole in the bowl.



Attach another stand with a single-row bowl to the toolbar.



Attach two plastic transparent (or telescopic) tubes from underneath the rear bowl to the rear shoes of the left and right furrow openers, and one tube from the single-row bowl to the rear shoe of the center furrow opener. Block the fourth hole in the bowl.



Take the Tropiculator to one end of the field and position the wheels in the furrows. Seat a person on the Tropiculator, facing rearwards, to drop fertilizer by hand into the front bowl.



Arrange for a second person to walk behind the machine and drop cereal seed by hand into the rear two-row bowl.

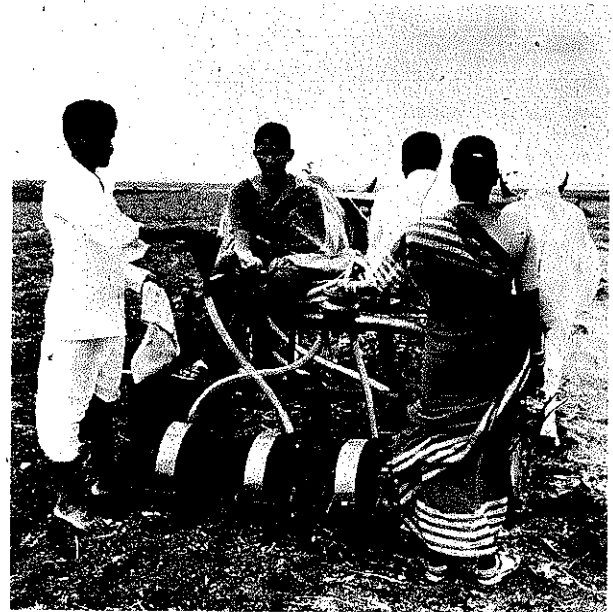

A third person is required to drop pigeonpea seed into the single-row bowl for the center row.



Lower the toolbar by pushing the handle backwards fully. Then start moving and begin dropping the seed and fertilizer. Continue sowing until the field is sown, following the procedure given above for sowing four rows.

Caution

1. Make a turn outside the field or in the waterway and lift the furrow openers fully before turning.
2. Drive the bullocks carefully so that they walk in the furrows and not on the adjacent broadbeds.
3. Never operate the Tropicultor without locking the handle in position.
4. Use adequate seed and fertilizer to obtain a uniform crop stand, and drop them evenly into the bowls.
5. Frequently check the seed and fertilizer openings at the furrow openers.

Four-row Mechanical Planter

Mounting the planter on the Tropicultor

Ensure that the wheels are fitted outside the Tropicultor frame and at a wheel track of 1.5 m, as shown in Figure 4. Then hitch the bullocks 1.5 m apart.

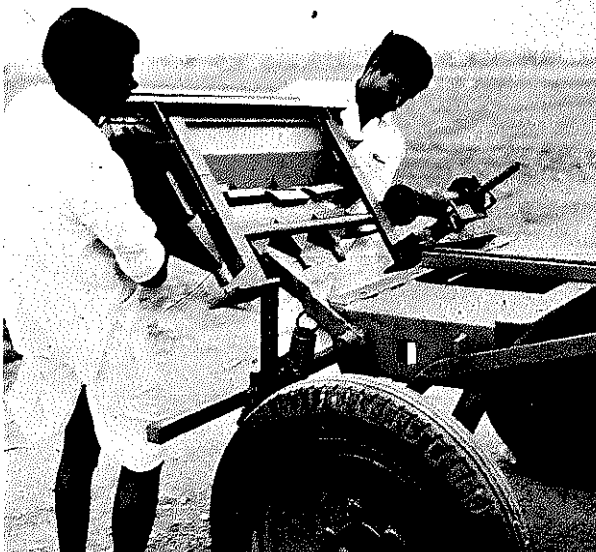

Lift up the planter assembly from both sides and rest it on the Tropicultor frame.

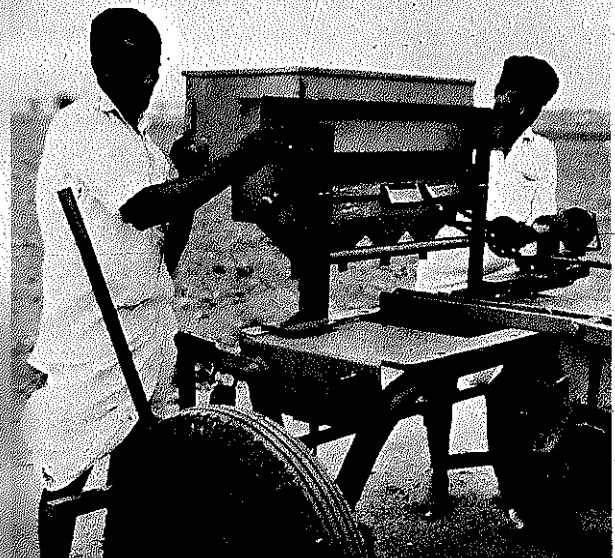

Position the holes on the planter mounting frame over the two outer holes on the rear flat.

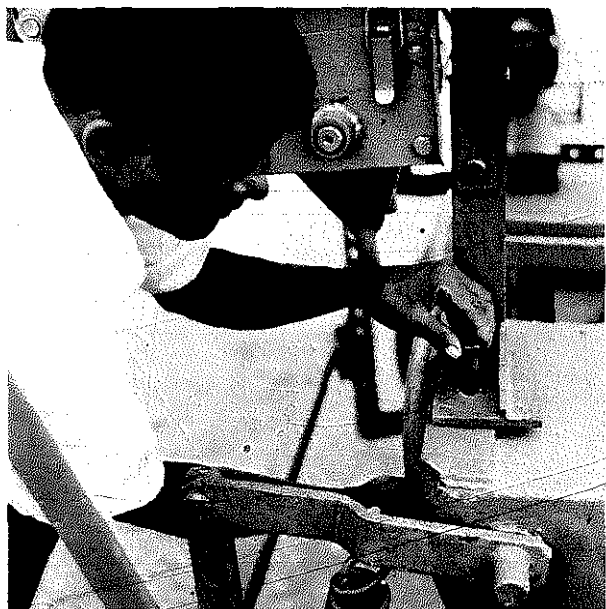

Insert the bolts from the upper side and hold a spring washer and a nut for each bolt underneath.

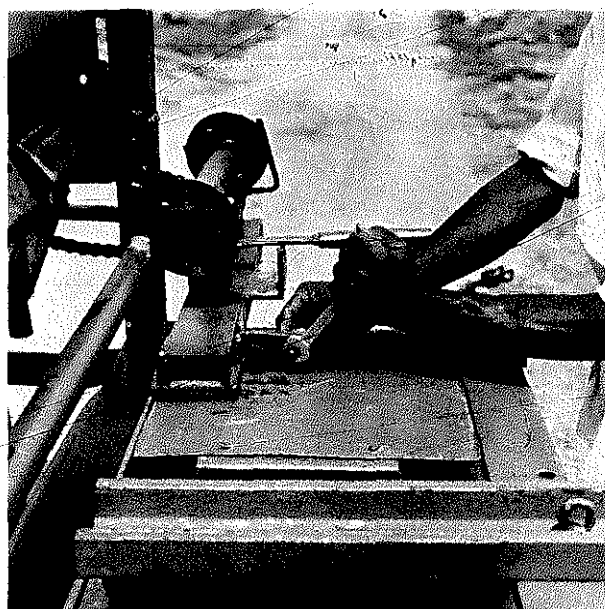

Attach the front support arm to the drive frame with two bolts.



Fix the front support arm to the Tropicultor by using another bolt, a spring washer, and a nut. Tighten all the bolts firmly.

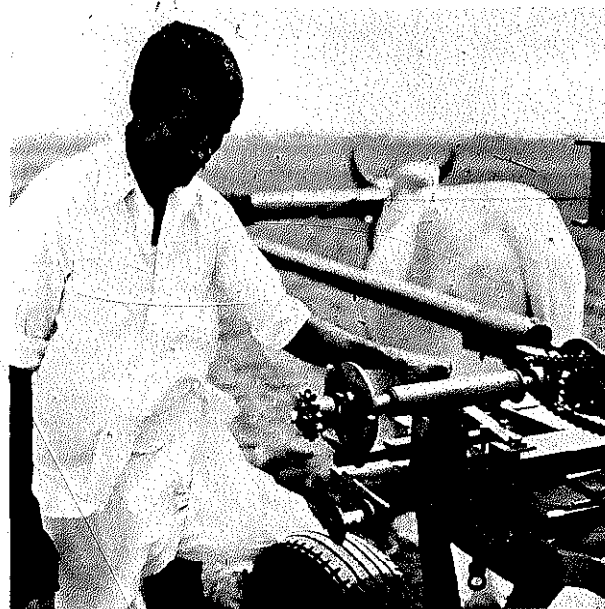

Operate the clutch lever and check the movement of the clutch plate.

Determine the adjustment position for the required fertilizer application rate, and the number of rows to be planted, from the calibration chart given in Table 1 (at the end).

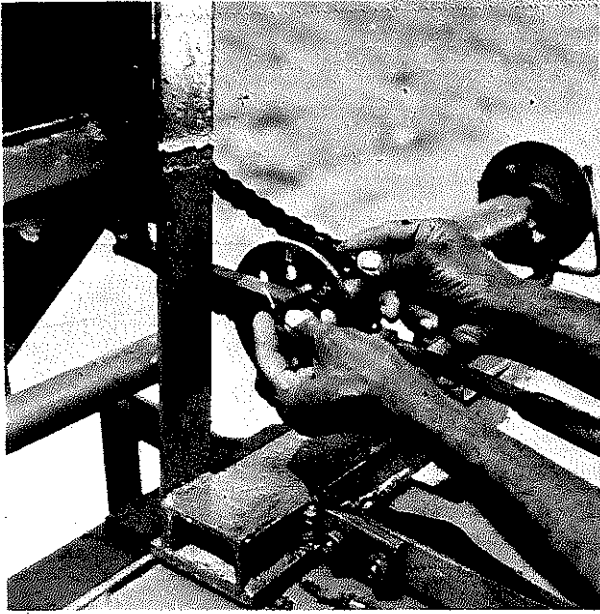

Open the nut to remove the connecting rod pin from the disc that drives the fertilizer trough. Then fit it in the hole bearing the same number stamped on the disc as the adjustment position determined from Table 1.

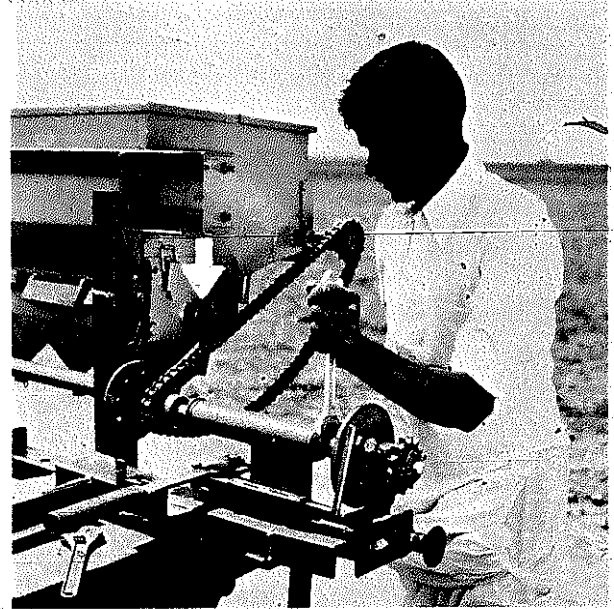

Rotate the drive shaft by hand and observe the backwards-and-forwards movement of the fertilizer trough link (arrowed). This should be equal on either side of the mean position.

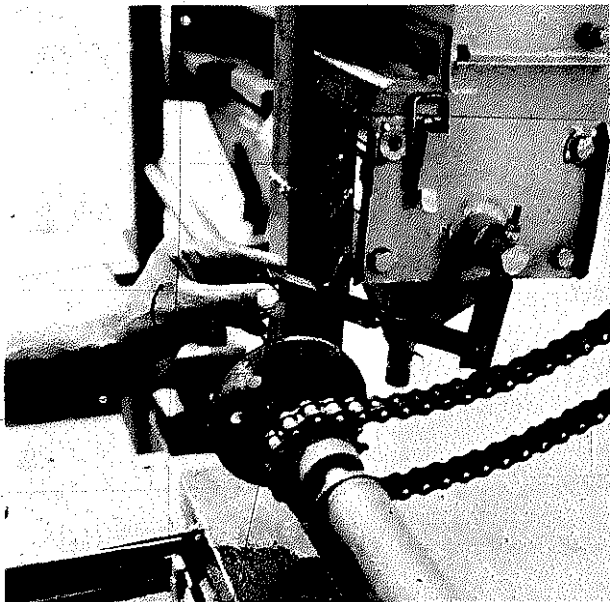

If it is not equal, disconnect the connecting rod from one end and adjust its length.

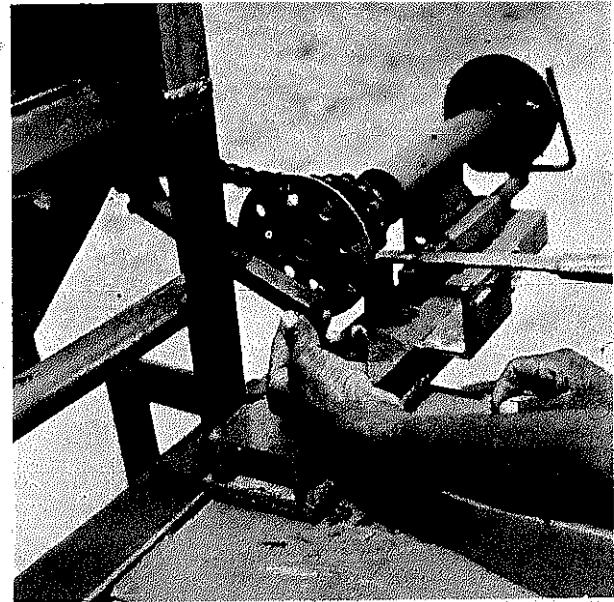

Replace the connecting rod on the pin and secure it in position.

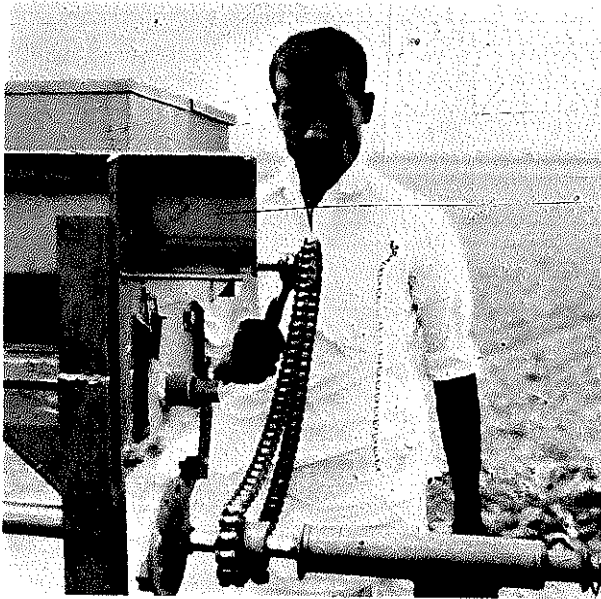

Check the alignment of the planter drive chain and adjust the position of the planter sprocket, if necessary.



Undo the wheel nuts of the left-side wheel.



Fit the sprocket support bracket on the wheel studs and replace the wheel nuts.

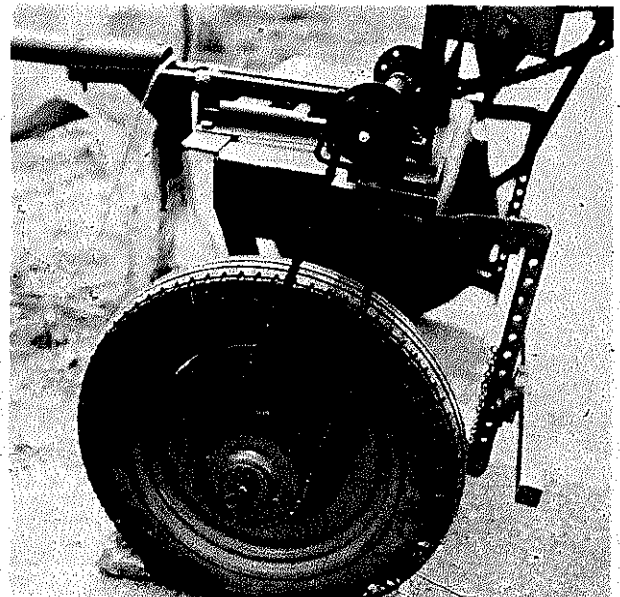

Place a roller chain on the wheel and drive sprockets passing over an idler.

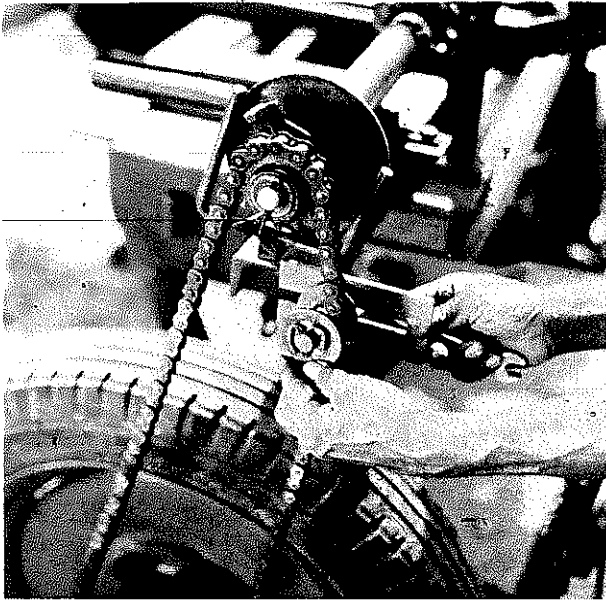

Adjust the position of the idler to obtain the correct chain tension.

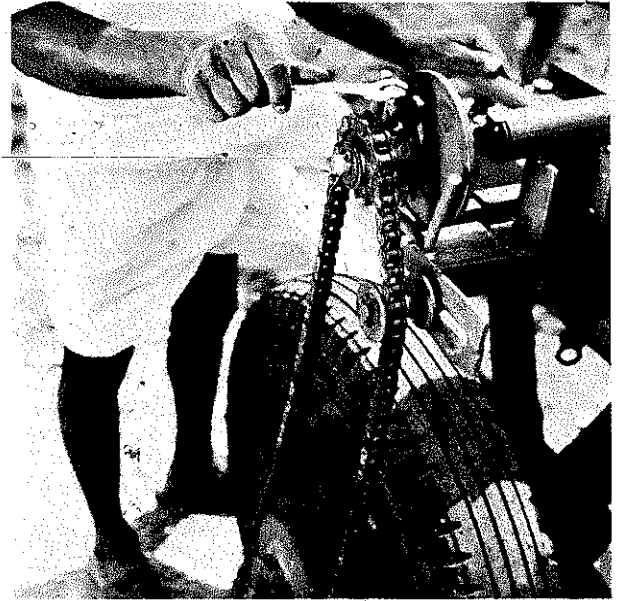

Adjust the position of the drive sprocket by loosening the bolt, if it is necessary to align the chain properly.

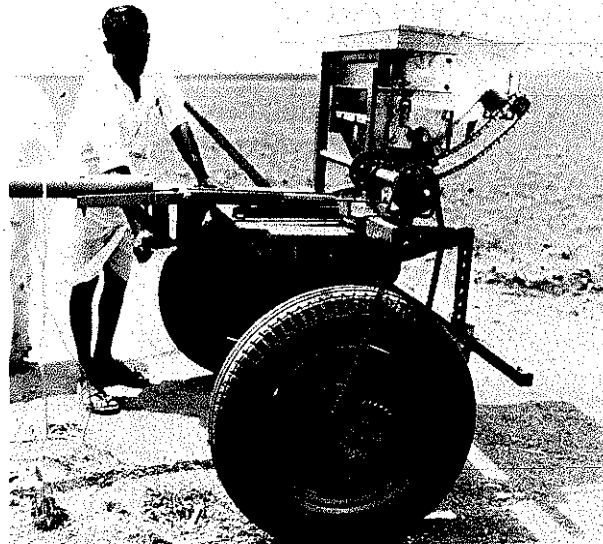

If the Tropicultor frame and planter top are not horizontal, as shown here, adjust the angle by turning the pitch screw.

Planting four rows at 30-cm spacing

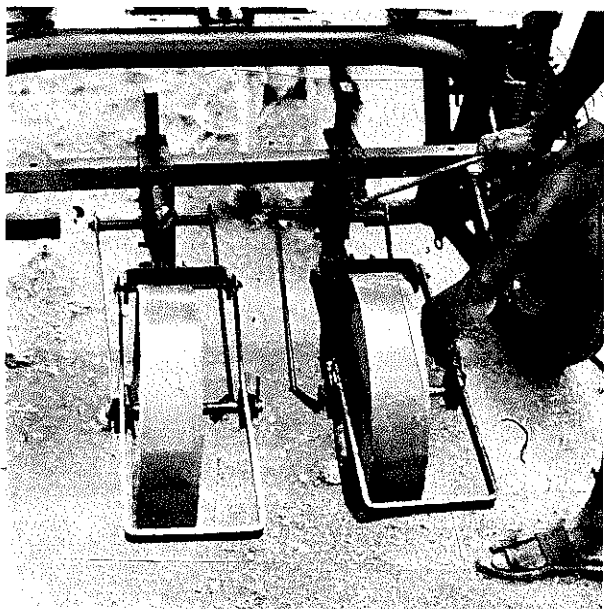

Fit two double-shoe furrow openers with rear shoes spaced at 15 cm from the center of the toolbar.

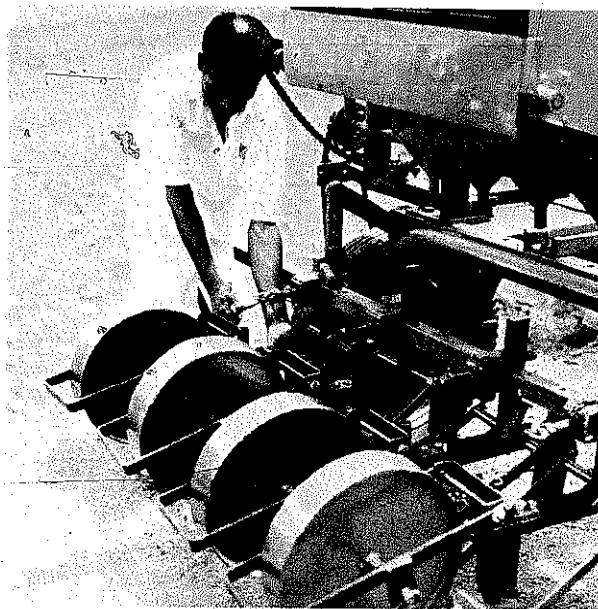

Fit the other two double-shoe furrow openers at 30 cm from the previous furrow openers.

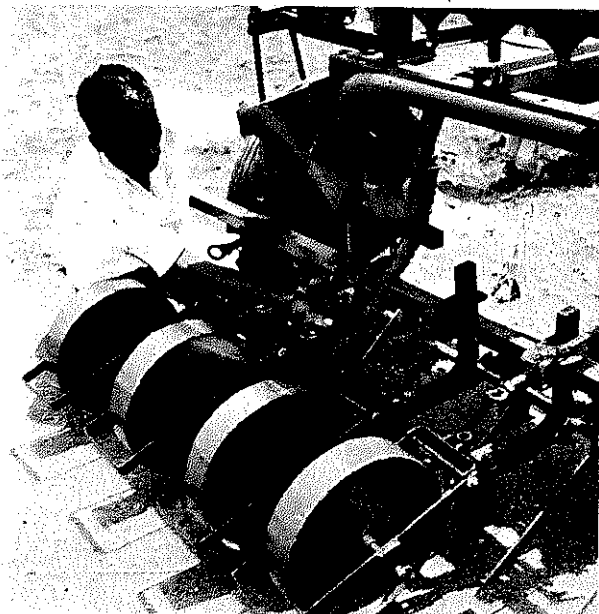

Check the height of the furrow openers by measuring their projection above the clamps. The height should be equal in all cases.

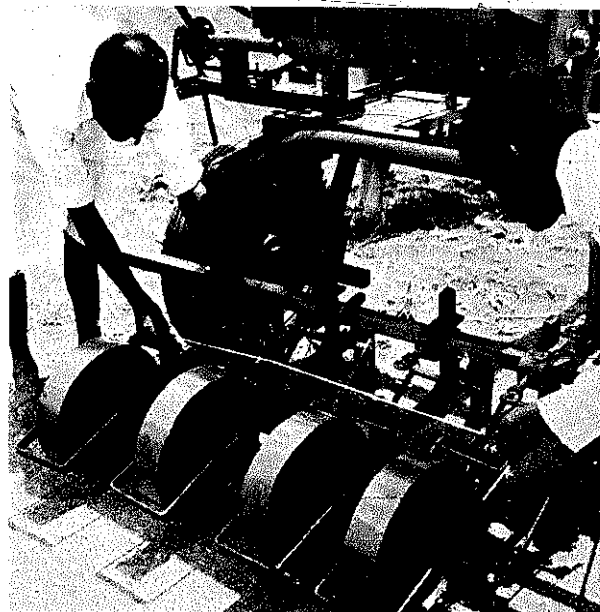

Check with a measuring tape that the distance between the furrow opener rear shoes is 30 cm in each case.

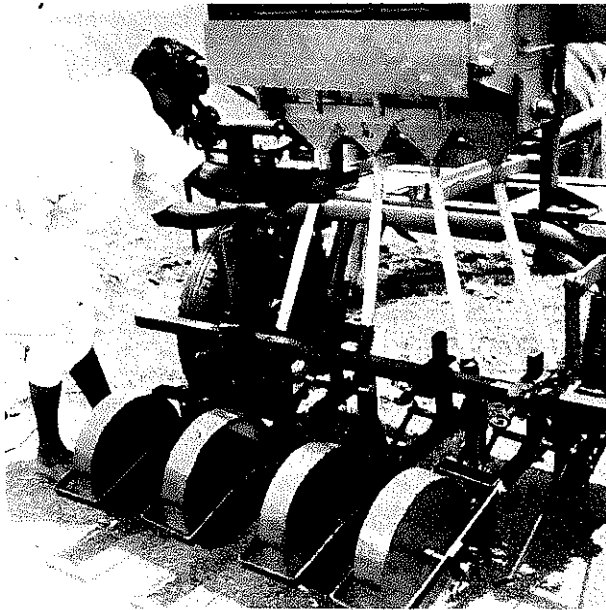

Attach four short telescopic tubes from the fertilizer outlet to the front shoes of the furrow opener.

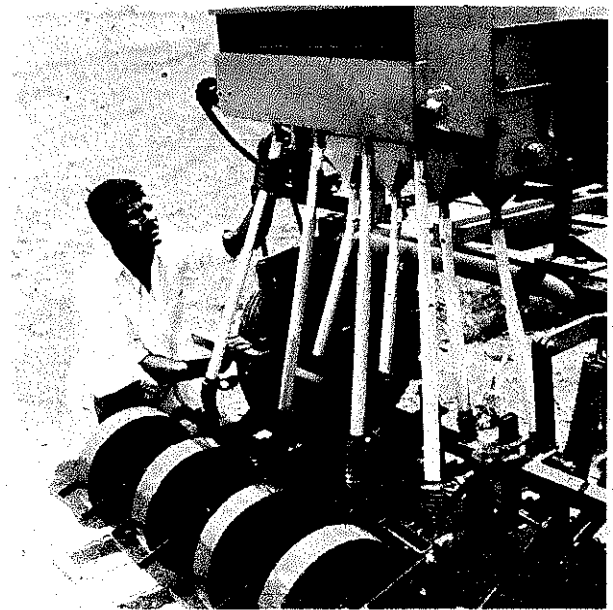

Attach four long telescopic tubes from the seed outlets to the furrow opener rear shoes.

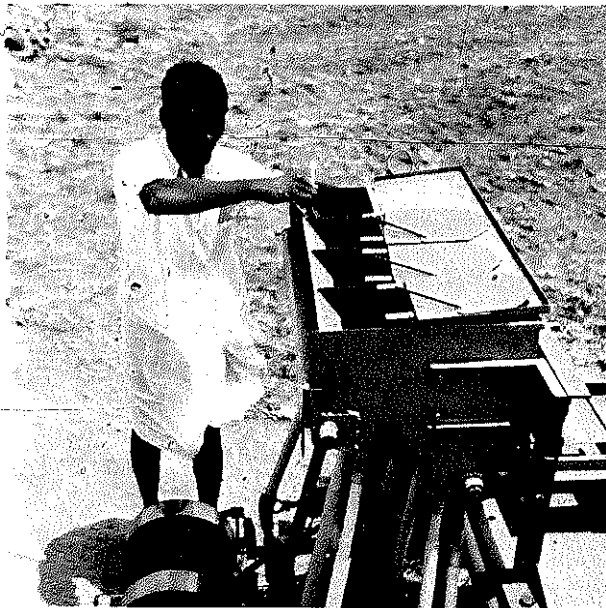

Remove all four shutter plates from the planter hopper.



Undo all four spring nuts.

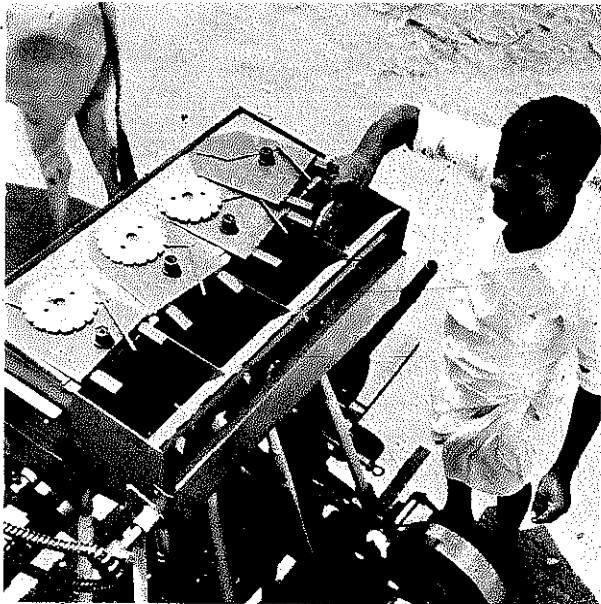

Take four seed-metering plates for the crop to be sown, following guidance given in Table 2 (at the end). Fit the seed metering plates on inclined discs in all four sections of the planter hopper and replace the spring nuts.



Fit back the shutter plates and close the shutters fully.



Ensure that the seed drain holes are closed and then fill the planter hopper with seed.

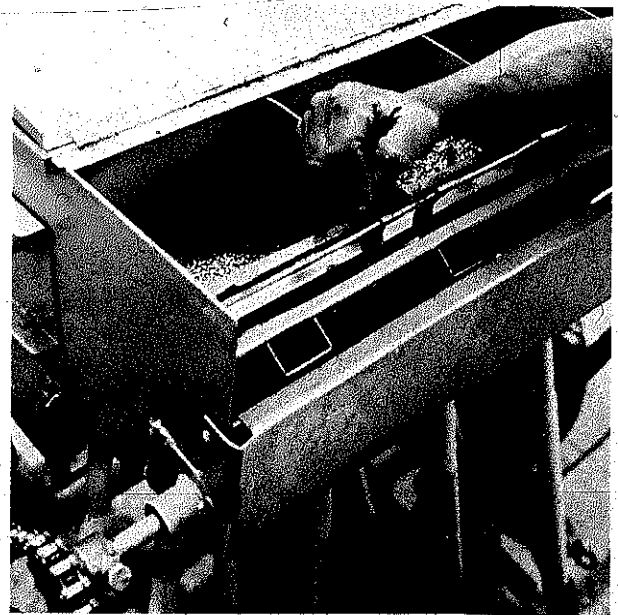

Open the shutters gradually until some seeds come into contact with the metering plates.

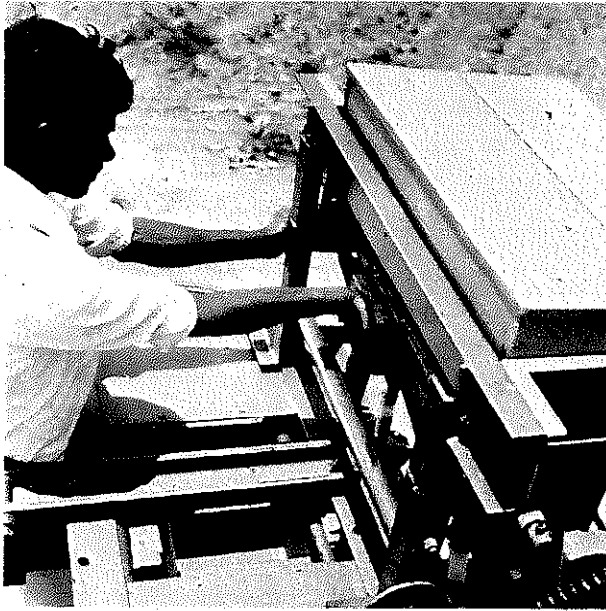

Close all four shutters at the base of the fertilizer hopper.

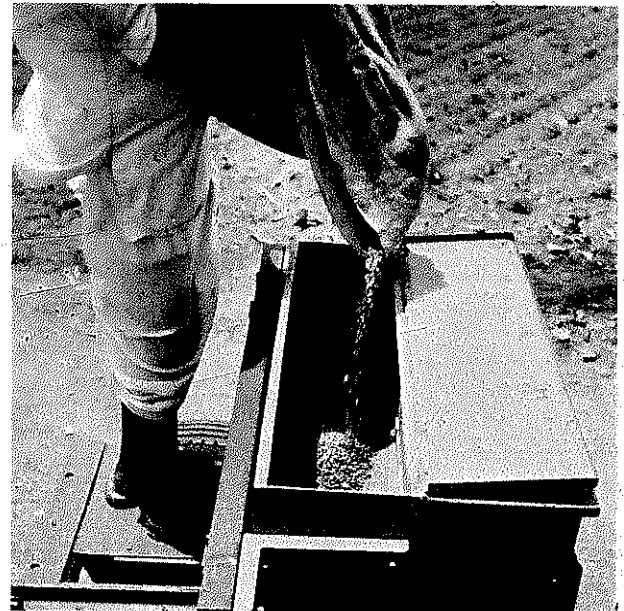

Fill the fertilizer hopper with fertilizer.

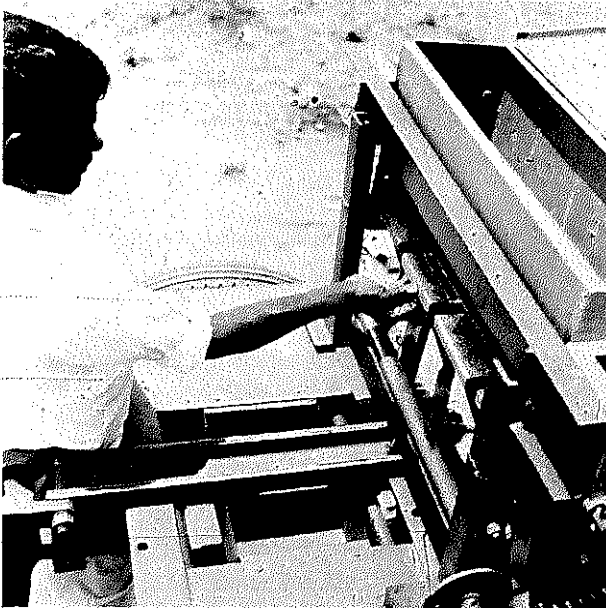

Open all four fertilizer shutters fully, one by one.

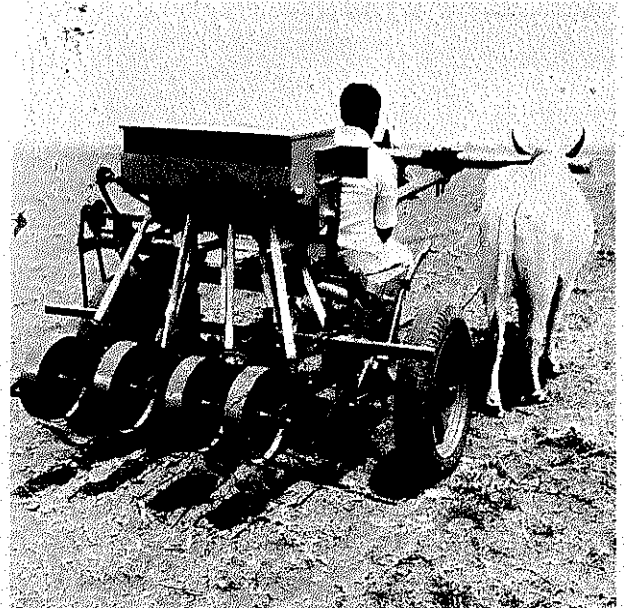

Disengage the clutch, take the Tropicultor to one end of the field and position the wheels in the furrows, and then engage the clutch.

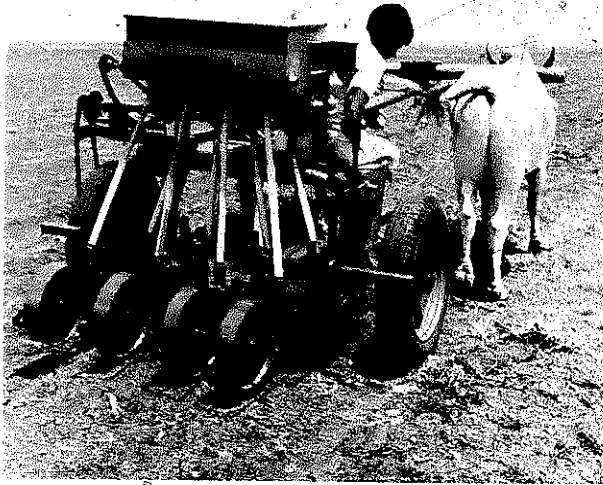

Lower the toolbar by pushing the handle backwards fully, and start moving.

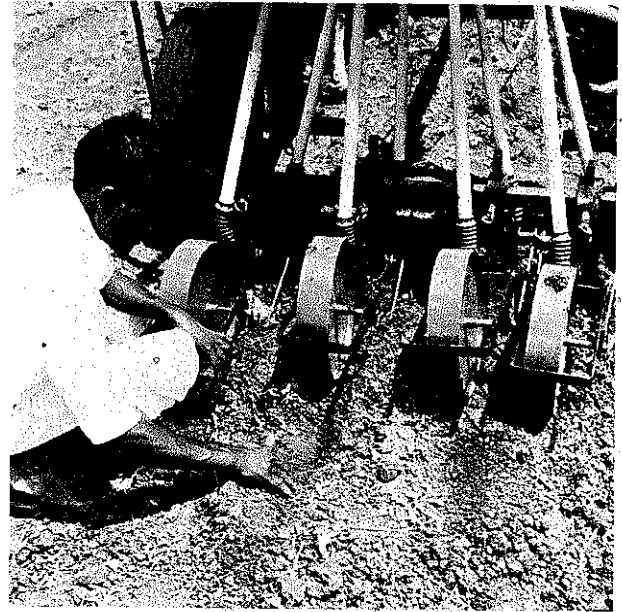

After going for 4-5 m check the depth of seed placement by carefully removing the soil from the seed rows for all four lines.



If necessary, adjust the depth of seed placement, either by changing the toolbar height ...

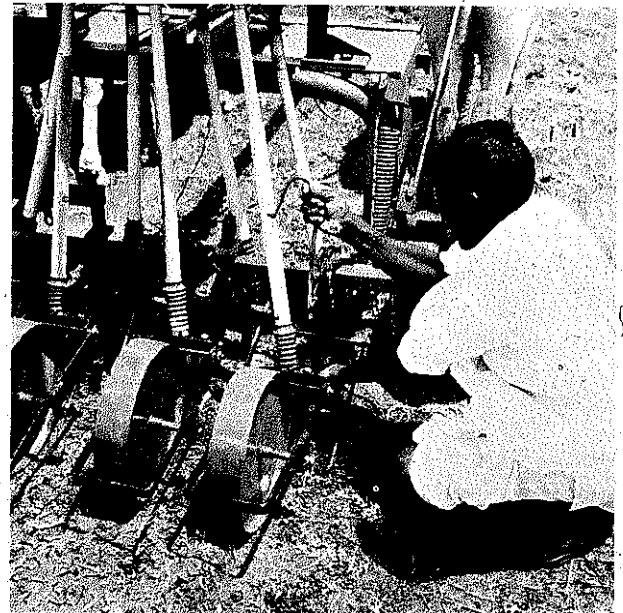

... or by loosening the individual clamps and sliding the furrow openers up or down. Tighten the clamps before restarting.



Check the depth of seed placement again, and adjust if necessary. At the end of the first pass disengage the clutch and lift the toolbar.

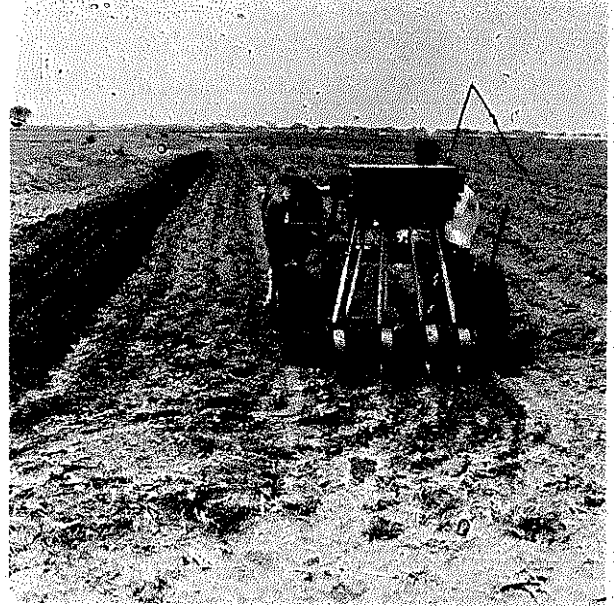

Make a turn and move to the third broadbed, engage the clutch, and start working.

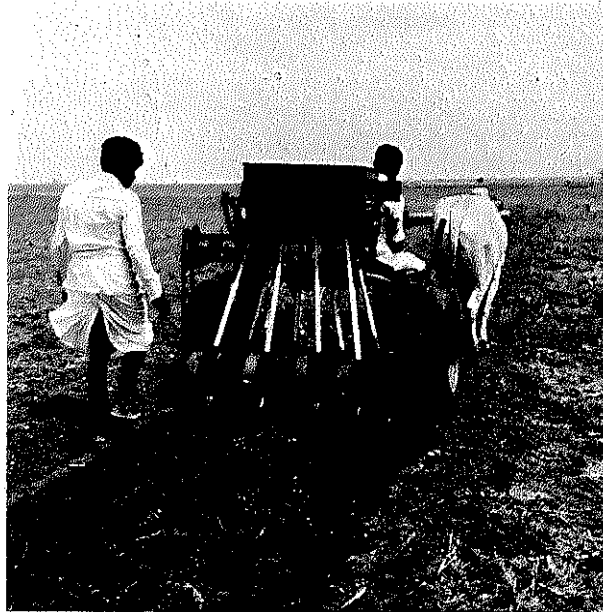

Continue sowing until all the field is sown. Check and refill the seed and fertilizer hoppers periodically.

Planting an intercrop at 45-cm spacing (for example, two rows of cereal and one row of pigeonpea)

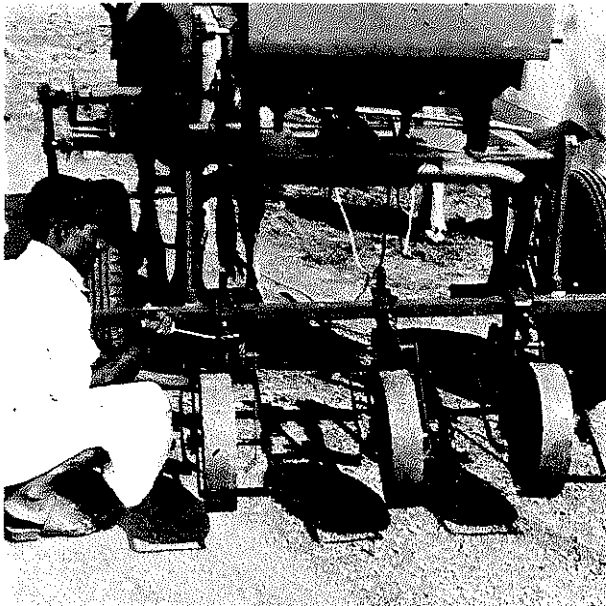

Fit one double-shoe furrow opener at the center of the toolbar and the other two furrow openers at 45 cm from the center.

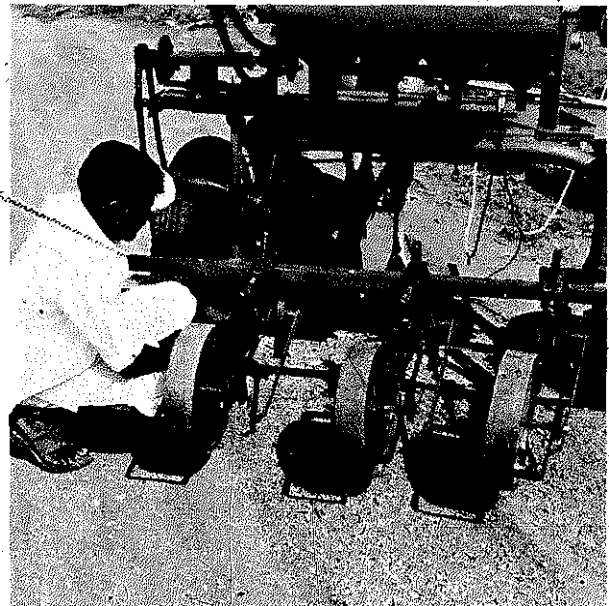

Check the height of the furrow openers by measuring their projection above the clamps. The height should be equal in all cases.

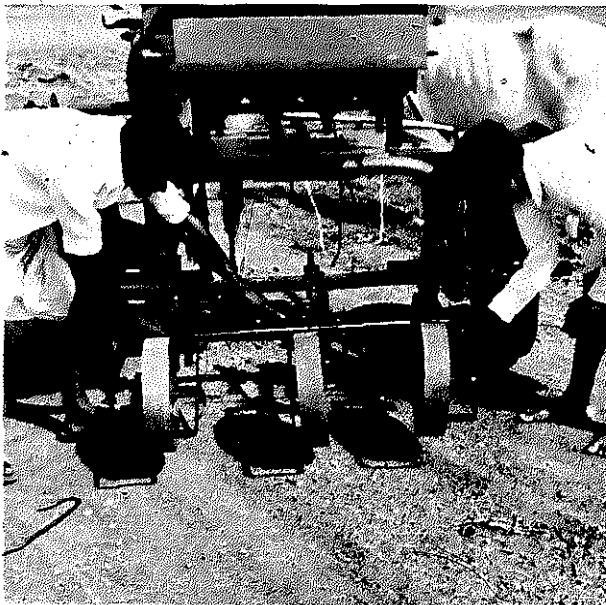

Check with a measuring tape that the distance between the furrow opener rear shoes is 45 cm in each case.



Remove the shutter plates from any three sections of the planter hopper and undo the spring nut.



Select two metering plates for the cereal crop and one metering plate for the pigeonpea crop (see Table 2).

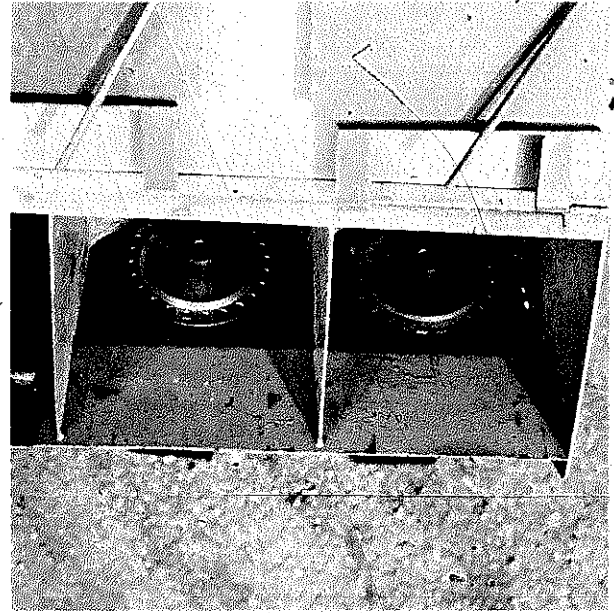

Fit the cereal plate in two outer sections and the pigeonpea plate in one of the two remaining sections of the hopper, and replace the spring nut.

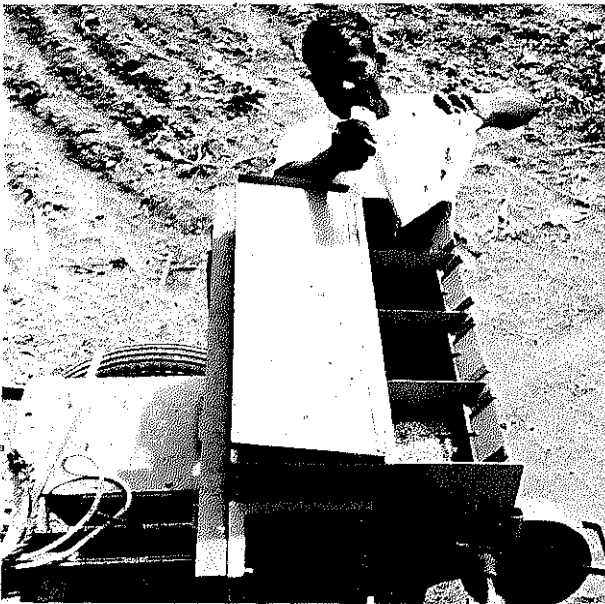

Put cereal seed in the outer sections of the hopper.



Put pigeonpea seed in the section fitted with the pigeonpea plate, and then open the shutters gradually until some seeds come into contact with the metering plates.



Fill the fertilizer hopper with fertilizer.

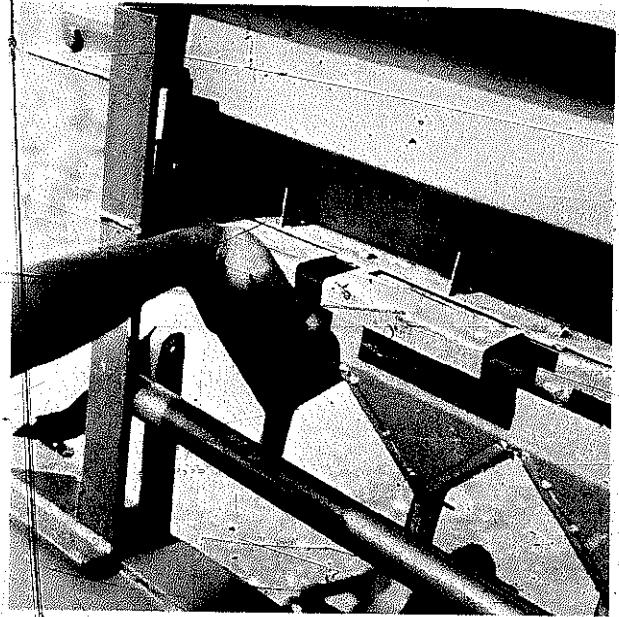

Open any three fertilizer shutters fully.

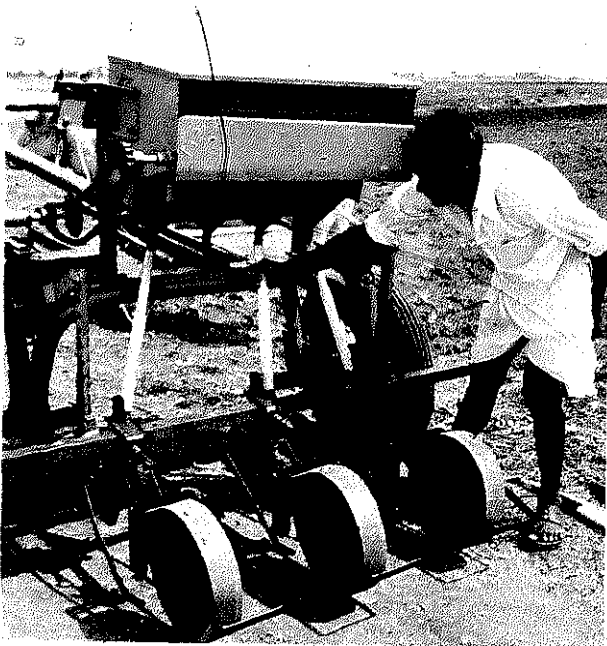

Attach three short telescopic tubes from the fertilizer outlet to the furrow opener front shoes.

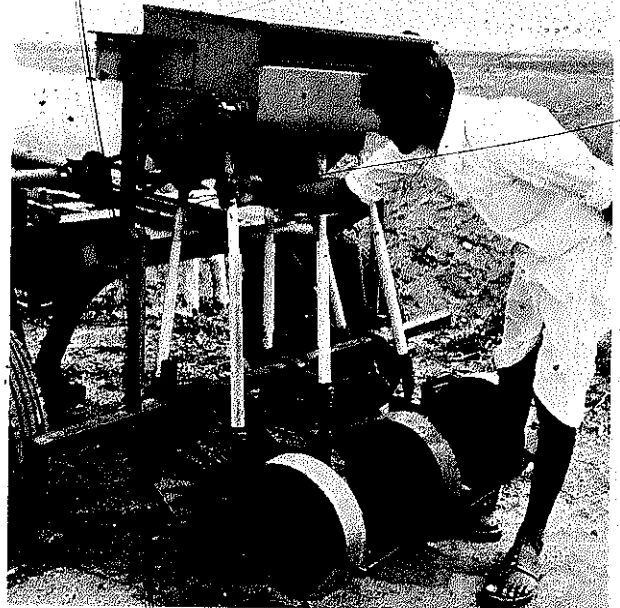

Attach three long telescopic tubes from the seed outlets to the furrow opener rear shoes.

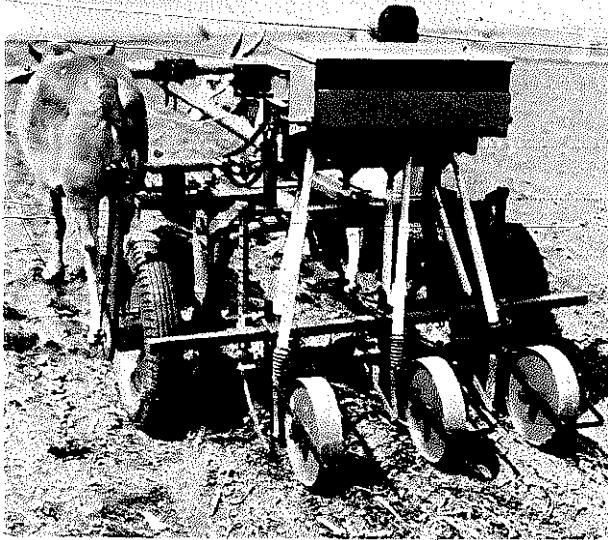

Take the tropicultor to one end of the field and position the wheels in the furrows, and engage the clutch.



Lower the toolbar by pushing the lever backwards fully, and start moving. For further steps follow the procedure given above for planting four rows at 90-cm spacing.

Caution

1. Before making a turn lift the furrow openers and disengage the clutch. Make the turn outside the field or in waterways and plant right up to the edge of the field.
 2. Drive the bullocks carefully so that they walk in the furrows and not on the adjacent broadbeds.
 3. One person in addition to the operator is required for planting. The second person should walk behind the machine to fill the hoppers, to ensure that the seed and fertilizer is flowing properly, and to assist in lifting of the toolbar.
 4. Always empty and clean the seed and fertilizer hoppers at the end of the day, as follows.
-

Cleaning the planter

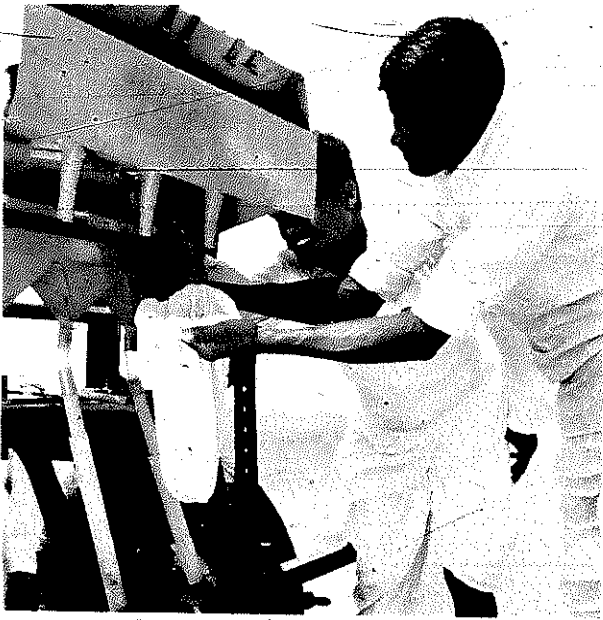

Hold a bag (or a tray) under the seed hopper and gradually open the seed drain opening by sliding a shutter. Collect all the seeds in the bag and clean the seed hoppers.

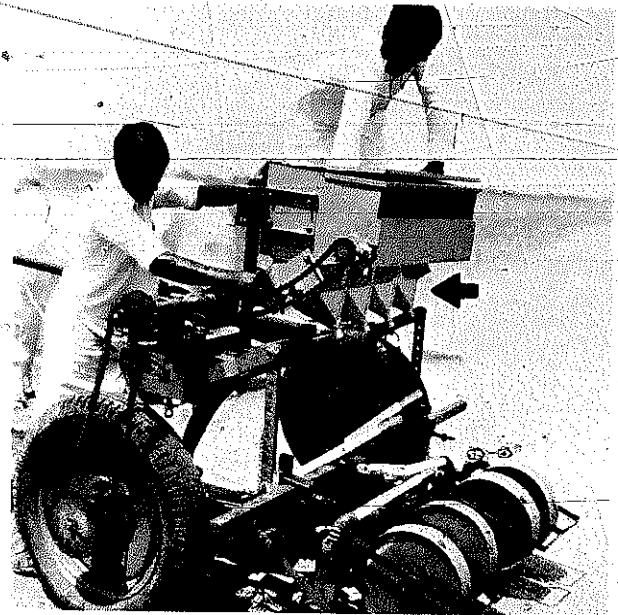

Spread a gunny bag or cloth on the ground under the fertilizer drill. Open the hinges at the side plates and swing down the trough (arrowed). Allow all the fertilizer to drop onto the ground and then clean the hopper properly.

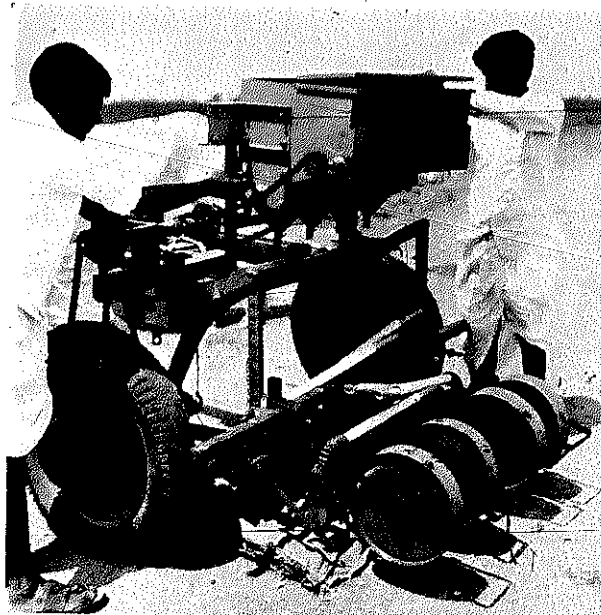

Fit back the side plates.

Interrow Cultivation

Interrow cultivation of crops at 30-cm and 45-cm spacing with a Tropicultor is explained here. Cultivation of crops grown at other spacings can be carried out in a similar fashion.

Interrow cultivation in a four-row crop spaced at 30 cm

Ensure that the wheels are fitted outside the Tropicultor frame at a wheel track of 1.5 m, and that the axle projections are equal on both sides, as shown in Figure 4.



Fit two ridgers on the toolbar, one behind each wheel.

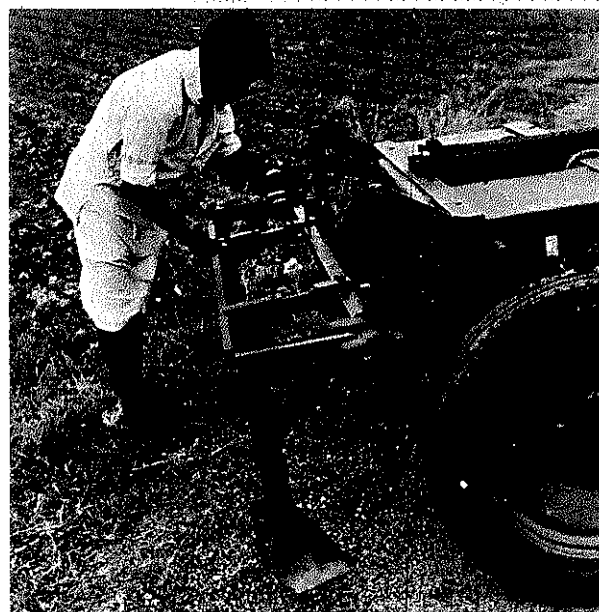

Fit a steerable toolbar on the main toolbar.

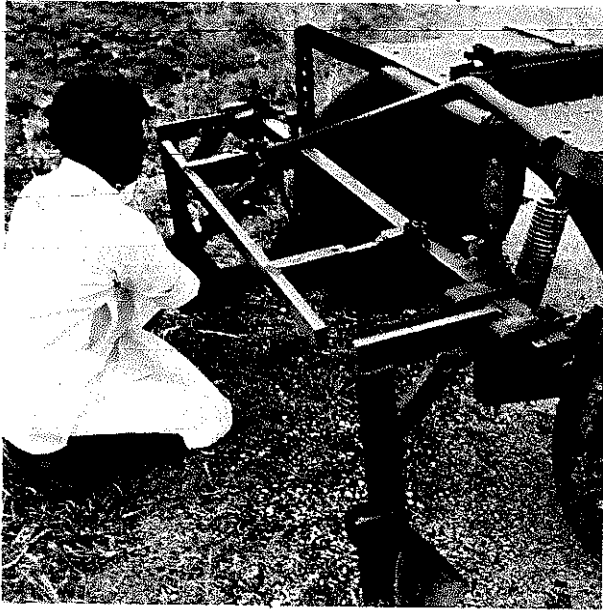

Fit a handle to one arm of the steerable toolbar.



Fit three rigid tines having 20-cm wide sweeps to the steerable toolbar, one at the center and one each on either side 29 cm apart, as shown in Figure 11.

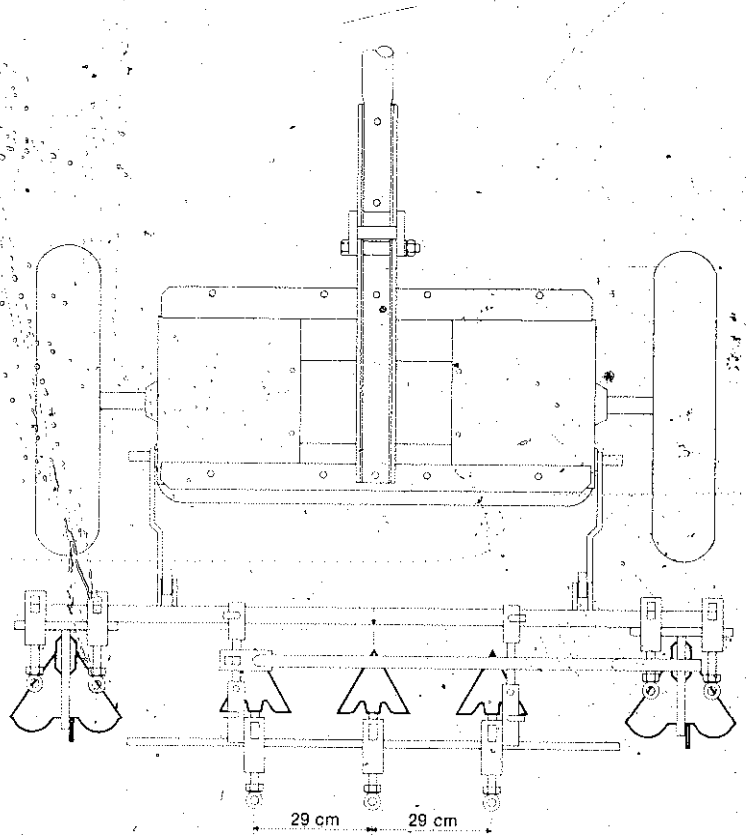

Fig. 11. Mounting position of three rigid tines and two ridgers.



Take the Tropicultor to one end of the field and position the wheels in the furrows.



Lower the toolbar and start working. Observe the depth of working and the position of the tines in relation to the crop lines.



Adjust the depth of working by loosening individual clamps and varying the height of the tines, as shown here, or by changing the height of the toolbar.



A second person is required to operate the steering handle when crop lines are not straight. Steer the tines by pushing or pulling the handle to avoid damaging the crop. Complete the interrow cultivation over the entire field.

Interrow cultivation in a three-row crop spaced at 45 cm

Fit two ridgers, a steerable toolbar, and a handle as shown in the first three steps for interrow cultivation in a four-row crop (see p.58). Then fit two 30-cm wide blade hoes onto the steerable toolbar at 22.5 cm on either side of the center, as shown in Figure 12.



Take the Tropicultor to one end of the field and position the wheels in the furrows. Make adjustments and do the operation following the procedure given in the previous section.

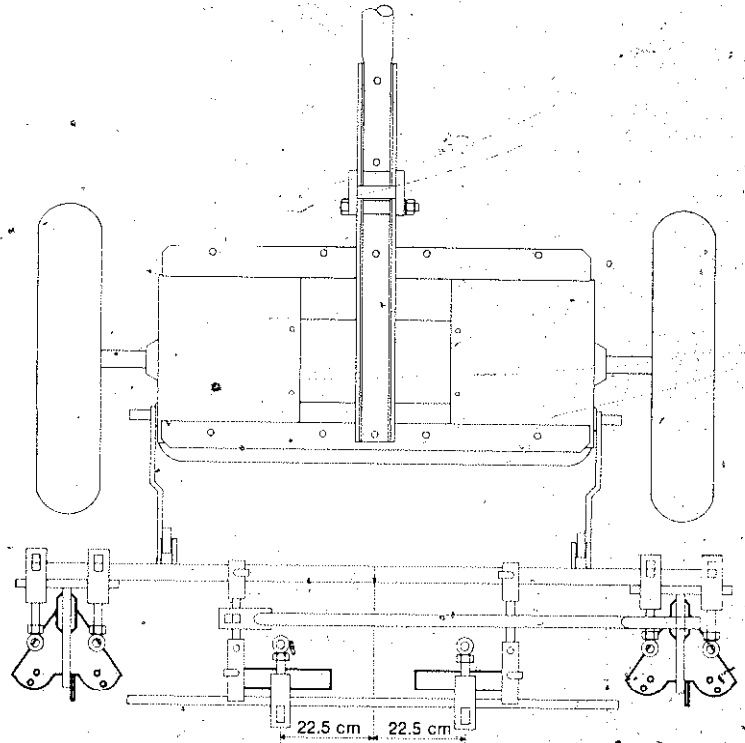

Fig. 12. Mounting position of two blade hoes and two ridgers.

Caution

1. Make a turn outside the field or in the waterway and lift the implement fully before turning.
2. Drive the bullocks carefully and steer the toolbar to avoid damaging the crop when the plants are not in a straight line.

Table 1. Calibration chart for the fertilizer drill.

Adjustment position no.	Ammonium phosphate (28:28:0) kg/ha*				Diammonium phosphate (18:46:0) kg/ha*				Urea (46:0:0) kg/ha*			
	No. of rows (row spacing)				No. of rows (row spacing)				No. of rows (row spacing)			
	1 (150 cm)	2 (75 cm)	3 (50 cm)	4 (37.5 cm)	1 (150 cm)	2 (75 cm)	3 (50 cm)	4 (37.5 cm)	1 (150 cm)	2 (75 cm)	3 (50 cm)	4 (37.5 cm)
1	11 (4)	22 (8)	33 (13)	44 (18)	21 (8)	42 (17)	63 (25)	84 (34)	15 (6)	30 (12)	45 (18)	60 (24)
2	25 (10)	50 (20)	75 (30)	100 (40)	27 (11)	54 (22)	81 (32)	108 (43)	23 (9)	46 (18)	69 (28)	92 (37)
3	31 (12)	62 (25)	93 (37)	124 (50)	33 (13)	66 (26)	99 (40)	132 (53)	31 (12)	62 (25)	93 (37)	124 (50)
4	37 (15)	74 (30)	111 (44)	148 (59)	38 (15)	76 (30)	114 (46)	152 (61)	34 (14)	68 (27)	102 (41)	136 (54)
5	42 (17)	84 (34)	126 (50)	168 (67)	44 (18)	88 (35)	132 (53)	176 (70)	41 (16)	82 (33)	123 (49)	164 (66)
6	47 (19)	94 (38)	141 (56)	188 (75)	47 (19)	94 (38)	141 (56)	188 (75)	49 (20)	98 (39)	147 (59)	196 (78)
7	51 (20)	102 (41)	153 (61)	204 (82)	54 (22)	108 (43)	162 (65)	216 (86)	53 (21)	106 (42)	159 (64)	212 (85)
8	58 (23)	116 (46)	174 (70)	232 (93)	60 (24)	120 (48)	180 (72)	240 (96)	56 (22)	112 (45)	168 (67)	224 (90)

* Figures in brackets are kg/acre.

Table 2. Seed metering plate selection chart.

Crop	Recommended				Actual			
	Seed rate (kg/ha)	Plants/ha	No. of rows	Plants/row/m	Seeds/row/m	Seeds/ha	Seed rate (kg/ha)	Metering plate designation
Sorghum	10	180000	3	9	15	300000	7.1	16S
Sorghum	10	180000	2	3	16	210000	5.0	16S;24S*
Pearl millet	4	180000	3	9	14	280000	1.6	16P
Pearl millet	4	180000	2	13	21	276000	1.5	24P;16P*
Maize	20	70000	2	5	6	85700	20	10M
Pigeonpea	10	60000	1	9	12	77000	7	24PP
Chickpea	50-60	330000	4	12	14	370000	73	20C
Blackgram	50-60	330000	4	12	14	362000	55.6	20C
Greengram (Mung)	20	330000	4	12	14	372000	9.5	16S
Safflower	10-15	90000	3	5	5	96000	4.5	16S
Horsegram	20	330000	4	12	17	448000	14.7	24S;16S*
Soybean		400000	4	15	19	560000	73	20C
Wheat	100	600000	5	12	16	733000	34	24S

** Use this alternative plate for higher or lower plant populations.

Note to collaborating publishers

This manual, initially published by ICRISAT in English and Telugu, is designed and intended for translation and additional publication in other languages. Organizations or publishers interested in such copublication are invited to write for information about the provision of artwork or negatives. Inquiries should be addressed to the Head of Information Services, ICRISAT, at the address given below.



ICRISAT

International Crops Research Institute for the Semi-Arid Tropics

ICRISAT Patancheru P.O.

Andhra Pradesh 502 324, India