

AT MICROFICHE REFERENCE LIBRARY

A project of Volunteers in Asia

Rural Tanning Techniques

FAO Agricultural Development Paper No. 68

by: Agricultural Engineering Branch,
Land and Water Development Division

Published by:

Food and Agriculture Organization of the
United Nations
Via delle Terme di Caracalla
00100 Rome
Italy

Paper copies are \$ 8.50.

Available from:

Food and Agriculture Organization
Distribution and Sales Section
Via delle Terme di Caracalla
00100 Rome, Italy

Reproduced by permission of the Food and
Agriculture Organization of the United Nations.

Reproduction of this microfiche document in any
form is subject to the same restrictions as those
of the original document.

RURAL TANNING TECHNIQUES



FOOD AND AGRICULTURE ORGANIZATION OF THE UNITED NATIONS

RURAL TANNING TECHNIQUES

Prepared by the

**Agricultural Engineering Branch
Land and Water Development Division**

on the basis of material supplied by

I. MANN

**Ministry of Agriculture
Animal Husbandry and Water Resources
Kenya, British East Africa**

FAO Consultant

First printing 1960
Second printing 1966
Third printing 1974

© FAO 1960

Printed in Italy

FOREWORD

This new volume in the Agricultural Development Paper series is intended primarily for agricultural officers and others responsible for the immediate supervision of hides and skins improvement programs, and, in particular, of rural tanneries using local raw materials. It is hoped that the information here presented will reach rural craftsmen through national extension services and, in order to make the book as useful as possible for training purposes, it is fully illustrated.

Rural Tanning Techniques gives a broad outline of selected methods and processes, and describes the tools and equipment required by rural tanneries; it indicates how improvements can be made step by step. It is hoped that even rural tanneries which have been established for centuries may benefit from the information given here. Since research is always going on, new tanning methods will undoubtedly be applied in the future. However, those described in the following pages are proven ones and are used to advantage in subtropical and tropical regions. Some chapters may be of value only for the more advanced rural tanners, but they have been included because they make the publication more suitable for the training courses organized by FAO. A glossary of technical terms is given, and a list of selected references to articles and books from which specialized information may be obtained.

One point regarding the use of this volume should be emphasized. Development programs in hides and skins often do not make a clear distinction between flaying and curing on the one hand and tanning on the other. An improvement program for tanning alone can be successful only when improved practices and techniques for flaying and curing have given positive results.

Such methods are described and illustrated in FAO Agricultural Development Paper No. 49, *Flaying and Curing of Hides and Skins*

as a Rural Industry (Rome, 1955). The present paper, therefore, should be used together with the earlier one.

The following have contributed information, sketches and photographs, and their co-operation is gratefully acknowledged:

Mr. R. Faraday Innes, former FAO Consultant and member of the FAO mission in Libya on hides and skins improvement and tanning

Dr. F. Olga Flint, Department of Leather Industries, Leeds University, United Kingdom

Mr. C. F. Harding, formerly with FAO mission in Libya and Iraq on hides and skins improvement and tanning

Mr. F. H. Hoek, FAO mission in India on hides and skins improvement, carcass and by-products utilization, tanning and leather utilization

Mr. E. Knew, formerly FAO Consultant, now with FAO mission in the Sudan on hides and skins improvement, tanning, leather and by-products utilization

Mrs. Erica Mann, Town Planning Department, Ministry of Local Government, Health and Town Planning, Nairobi, Kenya

Dr. Y. Nayudamma, Director, Central Leather Research Institute, Madras, India

Mr. J. H. Sharpouse, Head of Leather Department, College of Technology, Northampton, United Kingdom

Mr. F. Steiner, formerly with FAO mission in Haiti on hides and skins improvement and tanning

Mr. E. Taussig, FAO mission in the Philippines on hides and skins improvement, tanning, and leather utilization

Mr. G. C. van Hoorn, formerly with FAO missions in Iraq, Libya and Gambia and now with the mission in Turkey on hides and skins improvement, tanning, and leather utilization

CONTENTS

Foreword	v
Introduction	1
I. Raw material - Hides and skins	7
Histology	7
Factors influencing quality	12
Tanning	18
II. Local tanning equipment and basic process operations	20
Local tanning equipment	20
Basic process operations	23
III. Preparation of hides and skins for tanning	25
Soaking	25
Liming	29
Unhairing, fleshing and scudding	35
Rounding and trimming	38
Deliming, puering and bating	39
Drenching and pickling	45
IV. Vegetable tanning materials	52
General	52
Vegetable tannins for rural tanners	55
Blends in vegetable tanning as used in India	58

V.	Preparation of vegetable tanning liquors	61
	Grinding	61
	Leaching	61
	Continuous production of tan liquor	62
	Commercial extracts manufacture	66
	Use of the barkometer	67
	Basic principles of vegetable tanning	70
VI.	Tanning of heavy hides	72
	Sole leather	72
	Sole and other heavy leather	77
	General method of manufacturing East Indian tanned kips as widely practiced in India	80
	Vegetable tanned sole leather by rapid pit tanning process	83
	Rapid East Indian tanning of cowhides	88
VII.	Improved rural tanning in India	90
	Soaking	91
	Liming	91
	Unhairing and deliming.	93
	Bag tanning	95
	Initial bag tanning	98
	Layering	100
	Finishing	104
VIII.	Vegetable tanning of light leather	105
	Sheepskins and goatskins	105
	Rapid East Indian tanning of sheepskins and goatskins	110
	Calfskins	115
IX.	Fat liquoring, oiling and stuffing	116
	Sole leather	116
	Heavy upper and dressing leather	119
	Further details on fat liquoring and stuffing	125

X.	Leather finishing materials	132
	Proteins producing a gloss after glazing	132
	Waxes producing a gloss after brushing	137
	Gums and mucilages	137
	Resins	139
	Pigments	140
	Miscellaneous materials	140
XI.	Alum tanning	141
	Alum solution	142
	Thin alum paste	142
	Thick alum paste	142
XII.	Oil tanning	144
	Making reims	144
	"Raw hide" leather	145
	Oil tanned leather	146
	Chamois tanning of sheepskins	147
XIII.	Tanning of fur, wool or hair skins	150
	Correct preparation of the fur skins	150
	Preservation	150
	Tanning	152
	Chrome tanning of fur skins	152
	Tanning of hair skins with basic aluminium sulphate	155
	Fur skin tanning with vegetable and synthetic tanning materials	156
	Fat liquoring	158
XIV.	Dyeing and bleaching of furs	160
	Killing of hairs	160
	Mordanting process	161
	Bleaching	163
	Dyeing	164
	Dressing sheepskins for wool rugs	165

XV.	Preparation and tanning of reptile skins	167
	Snakes and lizards	167
	Preparation of snakes and lizards	167
	Crocodiles	169
	Progress of work at tannery	175
	Alum tanning	177
	Vegetable tanning	179
	Finish	179
XVI.	Parchment and vellum	181
	Liming	182
	Shaving	183
	Dusting	183
	Finishing	184
XVII.	Leather dyeing	185
	Natural dyes	185
	Artificial dyestuffs	185
	Use of dyes	189
	Methods of application	191
XVIII.	Planning a rural tannery	195
	Site	195
	Size	197
	Roof	198
	Floors and drains	198
	Basic sections	199
	Machinery	206
XIX.	Water	207
	Hardness	207
	Iron	208
	Contamination	209
	Sources of water	209
	Effluents	211

Appendixes

1. pH value in tanning	215
2. Tannery records	218
3. Conversion rules	220

Glossary	221
-----------------	-----

Selected references	241
----------------------------	-----

INTRODUCTION

Leather, which has been used by man for many purposes for thousands of years, is remarkable for possessing a combination of properties to be found in no other natural or man-made material. It can be so hard and tough that it requires working with a saw or lathe; yet it can also be as soft and flexible as a fine textile, a fit material for the needlewoman. Leather is not only strong, durable (when properly prepared, it will resist decay for centuries) and flexible; it has a unique porous structure which enables it to "breathe," that is, to permit the passage through it of air and water vapor. It can be easily worked, cut, joined, stitched, embossed, dyed and gilded. When cut, the edge does not fray — a characteristic which for some purposes makes it superior to woven materials. In the hands of a craftsman, leather will yield articles of use and ornament which cannot be produced in any other way.

Leather has been used for clothing for at least 7,000 years. In addition, it has for millenia been made into all kinds of tackle and gear — into ropes and reins, saddles, shields and armor; it has been used for tents, beds and carpets; it has been shaped and molded into cups, bottles, all kinds of water, oil and wine carriers; it has provided boats, sails, writing materials, decoration and ornaments; lanterns have been made of leather; even the floors of ancient Egyptian chariots were made of interlaced leather thongs.

To produce this versatile material, the craft of the tanner is required. How, when and where early man learned to make strong, flexible leather out of dry skins is not known. Nor is the origin of the preserving processes which use the chemical properties of tanning materials. Primitive hunters, killing wild animals for food, must soon have discovered that animal hides and skins gave protection

against cold, rain and thorns. They must also have found that dry hides rot when they get wet.

This would have led to attempts at preservation by scraping off the meat and rubbing in fat, brain and marrow to make the skins softer. Evidence of oil treatment has been found in the tombs of ancient Egypt.

True tanning may have been accidentally discovered by the immersion of raw skins in forest pools where the soaked leaves, twigs, fruit and bark would have given a tannin solution. Or it might have happened that a hide hung over a particular tree became tanned where it touched the bark; thus that part of the hide would have acquired new properties which made it more resistant to decay after subsequent wetting. In this way vegetable tanning materials were no doubt discovered.

Another primitive method of preservation, the use of smoke, was known in China, South America and the extreme north of Europe in prehistoric times, and was later invariably practiced by the North American Indians. The virtue of salt as a preservative has been known for thousands of years, and since some salts contain alum, the value of this mineral, too, as a tanning material was also probably discovered accidentally.

Using primitive tanning methods, anyone can produce some kind of leather. But only an expert tanner can transform dry, harsh hides and skins into fine quality leather, a beautiful material, pleasant and attractive in use and appearance.

During the present century many attempts have been made to produce substitutes for leather, such as impregnated textiles, rubber and plastic materials. Although these products have found wide use in the manufacture of footwear and other articles of everyday use, they have not been able to reproduce the particular properties of leather. The leather trade has taken special measures to popularize leather by disseminating information about the scientific reasons for its individual characteristics; thus, it has been pointed out that the superior insulating qualities of leather, its great capacity to absorb perspiration and its thermostatic properties cannot be duplicated by synthetic products.

Rural tanners, employing family labor and using local raw materials should be able to produce leather cheaply, at prices which will make leather articles available to the poorer classes; they can popularize

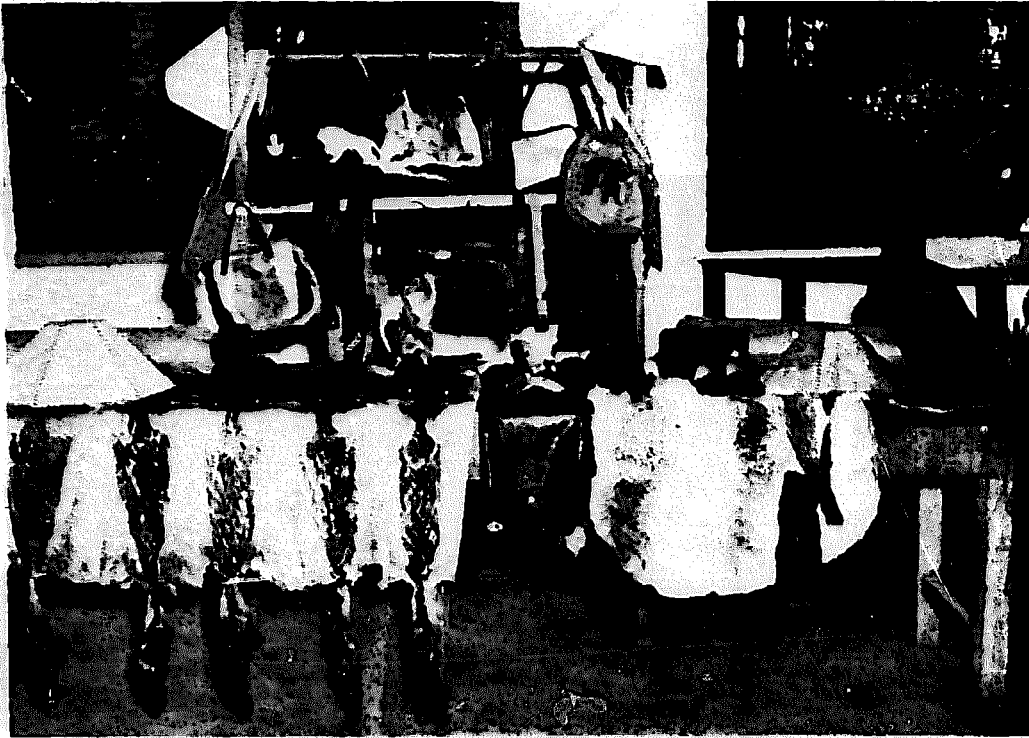

FIGURE 1. -- *Leather articles, some of which can be made by rural craftsmen.*
Courtesy Kenya Information Office, Nairobi

FIGURE 2. -- *Village tanneries are source of additional income to families.*
Courtesy Kenya Information Office, Nairobi





FIGURE 3. - *Operator engaged in preparing python skin.*

the use of leather as a material which is not only cheap, but also durable and beautiful, a material of which both producer and user will be proud (Figure 1). The production of cheaper leather in villages (Figure 2) will, in turn, encourage a secondary industry manufacturing leather goods of many kinds. Handbags, purses, sandals, slippers, belts, school satchels, cushions and other articles

can be sold not only in the rural community, but also to tourists and on export markets (Figure 3). Such a pair of linked industries will provide a living for many families and thus partly remove their dependence upon agriculture.

In many countries, rural tanning does not exist, even though the necessary raw materials — the hides and skins, lime and vegetable tanning substances — are locally available. This situation is not without advantages. In such areas it should be possible to introduce the industry in a satisfactory manner, free from the shackles of inherited habits, and using improved methods from the beginning.

In other countries where a traditional tanning industry exists, the tanners are often very conservative. However, once a technique has been shown to be better than traditional methods, and, above all, if the resultant product is cheaper and of better quality than that previously obtained, the tanners will be willing to adopt the new technique. The craft of leather making as practiced by rural tanners is frequently an inherited one, and sometimes confined to castes, as in India. The tanners of Northern Sudan and Nigeria are also typical examples of the way in which the family secrets of the trade have been passed on from generation to generation for centuries. From recent observations it is clear that the methods and the indigenous materials employed by the rural tanners have varied very little since ancient times, particularly in some of the less advanced Near East countries.

This static condition of the rural tanner is due to poverty, illiteracy, poor communications and lack of contact with modern scientific tanning methods which, if adopted with appropriate modifications, would greatly improve the rural tanner's working conditions, his position in local affairs and the reward for his labor.

The craft of tanning, inherited from generation to generation, has been based on experience gained by trial and error, although certain phenomena have not always been correctly interpreted. The modern approach is to trace, step by step, the conversion of hides and skins into leather and to understand all the physical and chemical changes involved in tanning. Many factors influence the final quality of the leather, such as the type and quality of the raw materials, the methods and processes employed, the skill of the worker, as well as environmental factors like temperature and climate. A factor of great importance in all tannery processes is the quality

of the water used. Hard water is unsuitable because it interferes with the processes and precipitates dyestuffs. Impure water may contain gelatine-liquefying bacteria and is detrimental to leather manufacture. Without some knowledge of such factors, disappointment and losses may occur. Failure should not, however, lead to discouragement, but to investigation aimed at improvement and better control of the various processes.

The purpose of this volume is not to give instruction in the manufacture of every kind of leather, but to teach rural tanners the fundamental principles and processes of tanning, so that they may be able to find out the reasons for mistakes and failures. Once the basic knowledge has been acquired, other methods may be learned from the many publications which exist. Some are included in the list of selected references given in this book.

It must always be borne in mind, however, that to master the craft of leather making, it is not enough to study books. To acquire skill, the tanner must make a thorough study of the processes involved, by repeated experiments and careful observation. He requires, above all, patience, practice, hard work and experience.

I. RAW MATERIAL - HIDES AND SKINS

Histology

Hides and skins are the raw material of leather. They are tissues of animal body made up of once living cells and their products. A hide or skin has many tissues. The production of leather involves the removal of those tissues which cannot be converted into leather and the treatment of the others in such a way that the final product has the desired properties.

The hide or skin of animals has a very complex and intricate structure. Knowledge of its construction and the complicated chemical and physical reactions and biological changes which occur within the skin before and during the process of leather manufacture enables the rural tanner to view his work with greater understanding and appreciation.

From the histological viewpoint, all mammalian hides and skins are more or less similar in their structure. They consist of three sharply defined layers which are distinct both in structure and origin (Figure 4). The three layers are:

- (a) the epidermis;
- (b) the corium or derma;
- (c) the hypodermis or subcutaneous tissue, which is commonly known as flesh or adipose layer.

THE EPIDERMIS

The epidermis is the outer layer of the skin. It is cellular in structure, and it has several distinct layers of self-reproducing epithelial cells. It has no blood vessels of its own, and the nourishment for

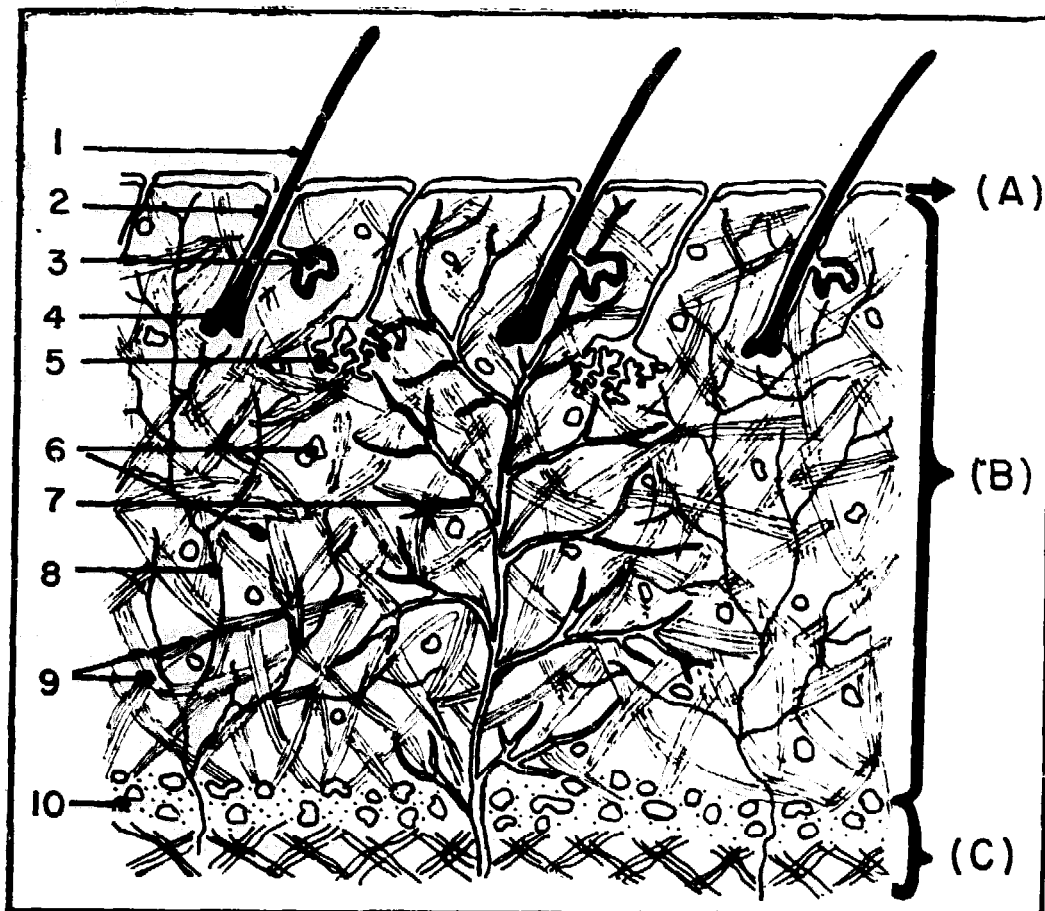

FIGURE 4. - *Enlarged diagrammatic cross section showing main layers of a hide:*
 (A) *Epidermis;* (B) *Corium or derma;* (C) *Hypodermis.*
 (1) *Hair;* (2) *Hair follicle;* (3) *Grease gland;* (4) *Hair bulb;* (5) *Sweat gland;*
 (6) *Fat cells;* (7) *Blood vessel;* (8) *Nerve;* (9) *Collagen fibers;* (10) *Fat tissue.*

Courtesy Mrs. Erica Mann

the cells is drawn from the blood and lymph of the derma, upon which it rests. The epithelial cells develop not only the epidermis, but also the hair, the sudoriferous and the sebaceous glands. The epidermis is composed of the protein keratin. It belongs to the same group of keratinous substances as nails, claws, hooves, scales and feathers.

The cells of the innermost layer of the epidermis are at all times reproducing new cells. They constantly grow outward and push the older cells in the upper layer. Since the upper layer is deprived of nourishment, it becomes flattened and hardened by dehydration.

In consequence, it dries up in the form of scurf or dandruff, which is more often observed on the scalp.

The cells of the innermost layer of the epidermis contain pigment granules which give color to the hairs and the skin.

THE CORIUM OR DERMA

The corium or derma — corium is the Latin for “true skin” — is the main portion of the integument — the natural covering — which is subsequently converted into leather. The derma is composed mainly of connective tissue fibers. Three different types of connective tissues — collagenous tissue, or collagen; elastic tissue, or elastin and reticular tissue, or reticulin — are found in the derma. Collagen constitutes the bulk, and it is the chief leather-forming constituent.

The corium may be further subdivided into two layers: the thermostat, or grain layer; and the reticular layer, or corium proper.

The grain layer is the upper portion of the corium, and it contains hair roots, glands and muscles. It constitutes only a small portion of the corium as a whole. None the less, it varies with the type of skin. As a rule, it is greater on skins and less on the heavier hides. In the grain layer the connective tissue fibers are quite small and fine. They are very compactly felted together without any apparent orderly arrangement.

The grain surface pattern produced by the arrangement of hair pores is distinct for each species of animals. The distinction is shown on the outer surface of leather. Thus, the pattern provides an easy means of identifying leather made from such different skins or hides as goatskin, calfskin, cowhide, horsehide, pigskin and dogskin (Figures 5, 6, 7, 8, 9 and 10).

The reticular layer is composed mainly of interwoven collagen fibers which are arranged in well-defined bundles. The fiber bundles of this layer are relatively much larger than those of the grain. The collagen fibers are straight or wavy threads and they are held in bundles by sheaths made of reticular tissue. They are supposed to be coated with a cement-like substance of interfibrillary proteins which encase the fiber bundles in dry hides. The reticular layer,

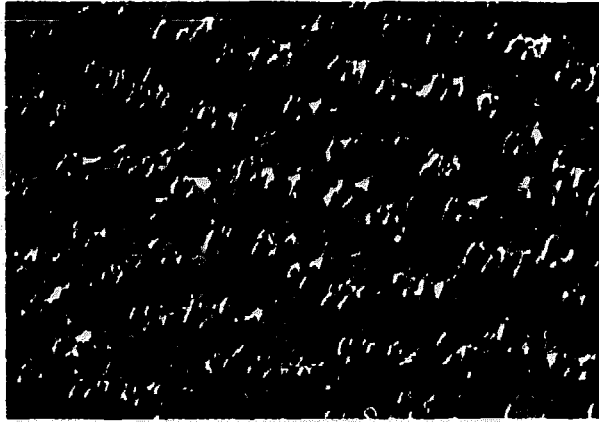

FIGURE 5. - *Photo showing grain structure of glazed goat-skin ($\times 20$).*

Courtesy Department of Leather Industries, the University, Leeds

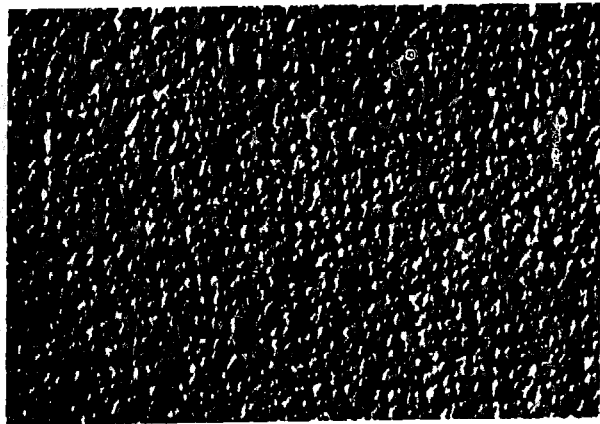

FIGURE 6. - *Photo showing grain structure of calfskin ($\times 20$).*

Courtesy Department of Leather Industries, the University, Leeds

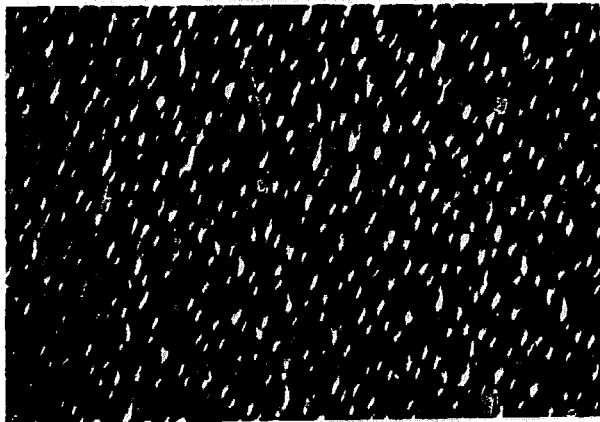

FIGURE 7. - *Photo showing grain structure of cowhide ($\times 20$).*

Courtesy Department of Leather Industries, the University, Leeds

FIGURE 8. - *Photo showing grain structure of horsehide (x 20).*

Courtesy Department of Leather Industries, the University, Leeds

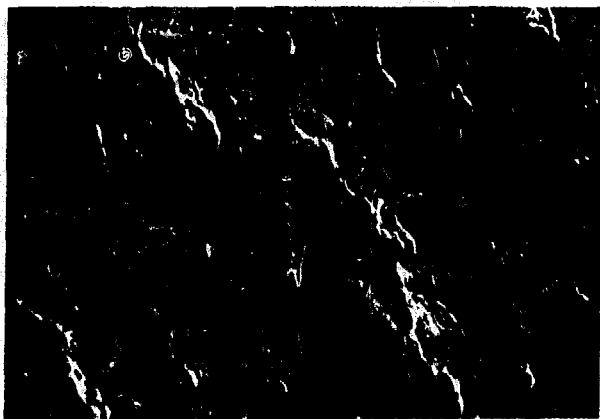
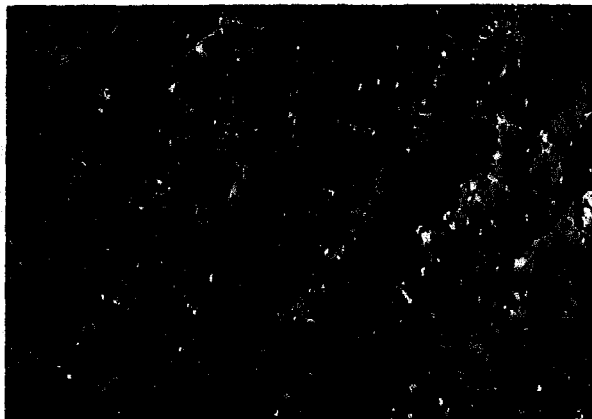

FIGURE 9. - *Photo showing grain structure of pigskin (x 20).*

Courtesy Department of Leather Industries, the University, Leeds

FIGURE 10. - *Photo showing grain structure of dogskin (x 20).*

Courtesy Department of Leather Industries, the University, Leeds



or corium proper, covers about 75 to 80 percent of the total thickness of a hide, and about 45 to 50 percent of the total thickness of a skin.

THE HYPODERMIS

The hypodermis, or subcutaneous tissue, is the loose connective tissue which joins the corium to the underlying parts of the body. It consists mainly of collagen and elastin fibers. These are loosely arranged, and they contain the adipose tissue which is the seat of fat deposits. Together, these tissues are what the tanner calls the flesh. It is removed mechanically in the fleshing operation before tanning. A twitch muscle is often appended to this layer.

Fat can be found with the adipose tissue on the flesh side, and the pieces can be large if the flaying has been badly done. It can also be distributed in the center of the corium in discreet fat cells. Then its extent and location depend on the breed of animal, its age and health, the season and the pasturage. In merino sheep, for example, the fat may be 20 percent of the skin weight; in steer hides it may be only 0.75 percent. When the quantities of fat are large, they cause the skins to be objectionably greasy after tanning. The fat cells may be so numerous — for example, in sheep — that they disorganize the corium fiber structure and cause a weakness or splitting of the leather. When such a skin is cured by drying or dry salting, the fat may melt and permeate it, particularly in a hot climate. Then the cure is ineffective. It becomes difficult to wet the skin back.

Water accounts for more than half the weight of a freshly flayed skin, whereas a tanned or a dried skin contains only 14 percent of water. This aqueous phase includes blood and lymph.

Factors influencing quality

Many believe that the tanning process can conceal the defects of raw hides and skins to such an extent that their original quality has no influence on the leather. This is not true. A good leather cannot be made from a bad hide or from a bad skin. On the contrary, tanning may well accentuate the tiniest blemish in some startling

way. The smallest pockmark can produce a hole. A scarcely visible gouge mark can cause the tearing of the entire skin. Every care must always be taken to produce and to select for tanning a raw material which is as free from defects as possible.

Even though dyes and pigments succeed in hiding some blemishes on the surface of the leather, they may accentuate others; or defects may appear once the leather has been used.

Many factors influence the growth and quality of the integument of any animal, whether wild or domestic. The breed and origin of the animal, its mode of life and its food, its general condition, its age and sex and the purpose for which it is bred affect the growth and the properties of the skin during the animal's lifetime. A cow bred for high milk production or a sheep bred for long wool, for instance, will yield a thin hide or skin; for the nutrimental food value has been absorbed by the milk or the wool.

Different types of raw materials are needed for different types of leathers. While a calf skin produces a high quality upper leather with a fine feel, a healthy ox or heifer hide produces only the firmest sole leather for which thickness and a high fiber weave are essential.

Thus the tanner must select his raw hides and skins according to the type of leather which he wishes to produce. He has, unfortunately, little power to control the various defects which influence the quality of raw hides and skins.

These defects are classified into two groups:

- (a) ante-mortem defects — these are damages caused on the living animal;
- (b) post-mortem defects — these are damages caused during flaying, curing, storage and transportation.

ANTE-MORTEM DEFECTS

The damages may be caused by (i) parasites; (ii) diseases; (iii) old age; and (iv) mechanical means.

The parasites, like the sarcoptic mange or the common demodex or demodectic mange (preferably termed *demodicosis*), ticks, lice and warble larvae, produce a pitted and scarred grain surface with

pinpoint holes, depressions, scars and warble holes. These defects greatly reduce the value of the leather.

Any prolonged febrile disease — for example, rinderpest and *trypanosemiasis* — has a substantial damaging and weakening effect upon the fiber structure of the hide. This results in leather of poor quality.

Other diseases caused by bacteria, fungi or virus can produce serious local defects, for heavy lesions bring about irreparable damage. They can be coupled with streptothricosis, ringworm and pox. Some seasonal diseases and nutritional faults severely damage hide and skin.

The hide or skin of any animal which has died of old age, disease or malnutrition, starvation or drought, possesses many defects which lower its quality. An animal which is flayed many hours after the carcass has lain on the ground — for example, a “fallen hide” — may have the underside damaged by putrefaction; the hide may show the discolored patches which are due to congealed blood in the veins. Flaying of a cold carcass and of fallen animals is exceedingly difficult; and, unless exceptional care is taken, there will be many knife cuts. Fallen hides are often of inferior quality. This will be due to poor flaying or to the state of the carcass, which is full of blood because it has not been bled.

Among mechanical damages, the hot iron branding causes irreparable losses. Millions of the world's hides and skins are damaged in this manner. Branding, whether for identification or curative purposes, scars and hardens the corium and renders it quite useless to the tanner.

Scratches from thorns, barbed wire or horns, whether healed or still open, are a very common type of the damage which is visible after tanning. The disfiguration greatly reduces the value of the leather and the extent of its uses. Grain-scratched sheep- and goat-skins, for instance, are generally used for suedes. The damaged grain of cattle hides is sprayed and mechanically treated to cover up and eliminate the blemishes. This is sold as “corrected grain” sides. Its commercial value is greatly reduced.

Other mechanical damages are caused by poke mark, goad mark, yoke mark and wounds.

Casting or hitting the animal shortly before death bruises the meat and causes an accumulation of blood over the bruised area.

The smaller blood vessels become ruptured and the flesh side of the fresh hide or skin appears red. This may involve putrefaction during drying or curing.

POST-MORTEM DEFECTS

These defects may be caused by (i) bad handling; (ii) bad flaying; (iii) inefficient curing; (iv) micro-organisms; (v) salt stains; and (vi) insects.

Man-made damage during slaughtering or curing has a pronounced influence on the quality of hides and skins. If carcasses are not bled out properly at the time of slaughtering, blood remains in the vessels and capillaries of the hides and skins. Bacteria then develop more rapidly, and there is putrefaction along the blood vessels. Moreover, the congealed blood in the veins may show up clearly on the grain surface of the leather in an unsightly way.

Rubbed or dragged grain. The dragging of a slaughtered animal over rough ground causes abrasion of the grain surface.

Bad pattern or irregular shape. When the carcass is not opened up correctly, the shape of the hide or skin becomes unsymmetrical. The tanner requires square hides and skins, and these are produced when correct ripping lines are used.

Flay cuts, gouge marks and scores. The use of sharp pointed knives invariably causes this type of damage. It can be avoided and entirely eliminated by the careful use of an improved type of knife which has a curved, convex cutting edge with a rounded tip. The back edge should be concave and blunt.

Drying. This is the simplest method of preserving hides and skins, but improper drying may destroy valuable material. Any delay in drying, either by suspension or on the ground, may cause "hair slip," or even putrefaction.

Hair slip represents relatively mild forms of putrefactive damage, but they may affect the surface of the hide and skin. Ground drying, however, produces the worst raw material; for then hides and skins are usually baked on the outside, while the center is still wet. This provides a ready medium for bacterial action, which invariably causes putrefaction (Figure 11). This type of putrefaction is generally termed "sun blister."

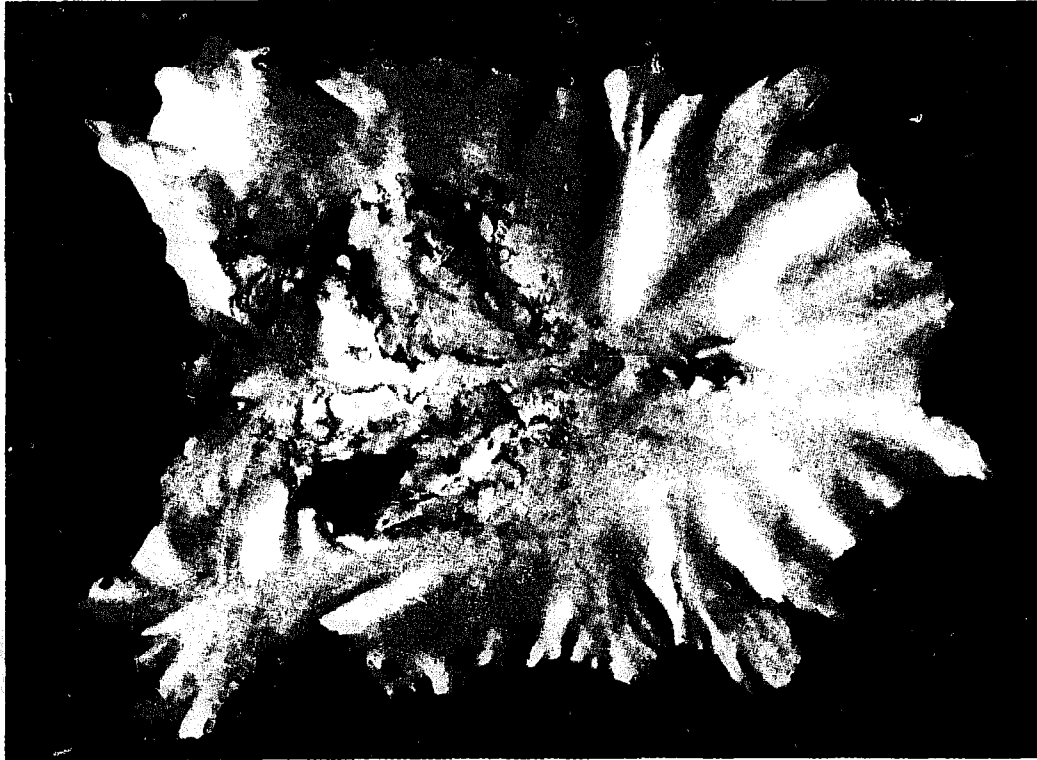

FIGURE 11. - *Skins damaged during flaying and curing by ground drying.*

Courtesy Kenya Information Office, Nairobi

Overdrying of skins may lead to grain cracking, especially when skins are allowed to crumple. A very long exposure to the sun causes the fat in the adipose layer of the skin to escape from its cells into the corium fibers. This makes its removal rather difficult during the process of leather manufacture, and it causes greasy stains.

The shrinkage temperature is 60° C. Raw hide suffers an irreversible shrinkage and damage when it is subjected to this temperature of 60° C for two or three minutes. It will suffer the same damage if it is kept under wet conditions and temperatures above 40° C. for longer periods of several hours. Once the skin is dried — that is, below 14 percent moisture content — it will stand these high temperatures much better.

These temperatures, it should be remembered, refer to the skin itself. They may be different from the temperature of the surrounding air. When the skin is wet, evaporation occurs; it cools the skin and gives it a lower temperature than the air. A wet bulb ther-

mometer reading will give an approximate idea of the skin temperature.

No matter how well the hide or skin has been prepared during flaying and curing, irreparable damage may still be done during storage. Once hide beetles — and, in particular, their larvae — and white ants have obtained access to the goods they can destroy them. A very good protection against the ravages of these insects, however, is the use of insecticides. These may be applied either in liquid or powder form. Recently, a successful preservation of dried hides and skins against attacks of beetles, moths and other insects has been achieved by spraying with a 5 percent suspension of sodium silicofluoride, or dusting with 0.5 percent gammexane powder, or spraying with 0.25 percent solution of sodium arsenite.

Rats and other vermin are also attracted by the fatty nature of hides and skins. They can cause substantial damage by gnawing holes, especially on folds.

Even transport has a bearing on the quality of raw hides and skins. Hides and skins are often loaded singly on to lorry transport and bullock cart, or they are tied in loose bundles. In consequence, any movement makes the surfaces rub together and causes damage, especially to grain, folded edges and corners. The rubbing damage during transportation, the use of baling wire and — worst of all — the wetting from exposure to rain, ruin the goods before they reach the tanner.

Prolonged retention of raw hides and skins in a smoky store leads to the so-called "smoked" goods. Smoking during drying will partly or wholly cause a tanning effect. This tightens the hair and creates difficulties in the liming and tanning processes. Smoke contamination on exposed grain where the hair has slipped before drying may cause discoloration and coarseness after vegetable tanning.

Hides and skins cured by salt may be spoiled if the techniques are inadequate. It is useless to salt goods which are already dry or partly dry, for the salt will not penetrate into the material. Neither can salt be properly absorbed by uncleaned hides and skins which have an excess of flesh. When too little salt is used, hair slip, or even putrefaction, may develop. Storage of salted skins in the wet state — for long periods during hot weather and in air with a high humidity — is dangerous because putrefaction bacteria can become salt tolerant.

Full information on the techniques of salt-curing is found in FAO's Agricultural Development Paper No.49, *Flaying and Curing of Hides and Skins as a Rural Industry*. Common salt, it must be emphasized, has definite limitations as a hide-curing agent. For one thing, putrefaction is not wholly arrested if salted skins are kept in wet conditions both for some length of time and simultaneously at an elevated temperature of 27° C. to 39° C. If the preservation is to be complete, the salt should be mixed with some type of anti-septic, such as sodium fluoride or sodium pentachlorophenate. "Red heat," a discoloration of salted hides and skins caused by bacteria, may lead to putrefaction. Marine salt is likely to be contaminated with salt-loving bacteria which develop "red heat."

The presence of substances, like iron, in the curing salt is harmful. They may lead to indelible stains during curing or in the processes of tanning. In certain parts of the world so-called curing salts contain but little true salt; the main components are insoluble earthy materials. Although exact figures are not available, the total losses caused by avoidable damage to hides and skins in the course of flaying, curing and preservation must amount — even at a conservative estimate — to millions of dollars a year throughout the world.

Damaged stock — the tanner, actual or potential, must realize — produces poor leather. "Good leather," as the old saying goes, "is made only from good hides and skins." In all probability tanning projects will be a complete failure, and all efforts and funds invested in them will be wasted, unless there is, first of all, a forceful drive toward improving the raw hides and skins.

FAO's Agricultural Development Paper No. 49 shows clearly how serious are the losses which can occur during flaying, curing and handling. Its chapter on "Proposed Development Scheme" emphasizes the need for continuous guidance by governments.

Tanning

The art or technique of converting hides and skins into leather is called tanning. Leather is animal hide or skin so treated that it becomes more permanently resistant to decomposition when wet, and supple when dry. By tanning, the easily putrescible hide substance is made resistant to micro-organisms.

There are many different ways of tanning, and a large variety of materials of vegetable or mineral origin possesses the property of being able to "tan." The prospective tanner, therefore, should make a survey of the local indigenous tanning materials, whether it be bark, wood, pods, tubers or leaves, and so estimate future supplies. It is necessary to make sure that the essential tanning materials are available: otherwise failure of supply may well seal the fate of a projected rural industry.

Many vegetable tannins are known. New materials, both mineral and synthetic, are constantly discovered and manufactured. It is reasonable to expect, however, that a suitable vegetable tanning material can be found in the neighborhood and is well known to the inhabitants.

II. LOCAL TANNING EQUIPMENT AND BASIC PROCESS OPERATIONS

Local tanning equipment

The conversion of hides and skins into leather looks like magic to a layman, and it is difficult for a novice to appreciate its complexity. Yet no costly tools nor machinery are needed; nor is a high standard of general education necessary. Successful tanning is based on knowledge, skill and experience; a start could be made on a small scale in, perhaps, a backyard, or in the open air (Figure 12), or preferably in a small building (Figure 13).

SKINS

For the beginner, sheepskins are preferable to goatskins; cattle hides should not be used. To avoid loss it is wise to start with damaged skins, preferably small pieces which have little or no commercial value.

TOOLS

The tools and implements needed are described in the chapters on the particular processes. Most of them can be made by the tanner himself or by rural carpenters and blacksmiths.

BUILDING

At first any shed which protects the worker from the weather and allows him enough light will do.



FIGURE 12. - General view of typical small rural tannery, Nigeria.

WATER, LIME AND TANNING MATERIALS

Information on these subjects is given in later chapters.

VESSELS

Iron vessels cannot be used because iron, when in contact with vegetable tanning infusions, gives an "ink" which produces bluish-black spots and stains on the leather. Tin cans quickly become rusty at the seams or wherever there are scratches and dents: and iron is exposed. Vessels made of wood are best, if cheap, for they are long-lasting. Whenever possible, small wooden casks should be used. Larger casks can be cut in half and thus provide two very useful vessels.

Glazed earthenware pots, if they have sufficient capacity and a large mouth, are excellent. Unglazed pots leak and thus they lose much of their contents, but they are improved by a coat of paint containing linseed oil. Pots should not be sunk into the ground. Although this is done in some regions, the practice makes them difficult to clean.

An example of excellent earthenware pots are the *magoors* used



FIGURE 13. - *Rural training center, Bakshi-ka-Talab, Uttar Pradesh, India. In foreground, fleshing and unhairing of hides; in background, lime pits.*

by the Sudanese tanners. They are about 90 centimeters both in diameter and in height. Similar pots are used by the Nigerian tanners (Figure 14) and also in certain regions in the Far East.

At first, aluminium pots may be used, but the cost is prohibitive when more than a few skins have to be handled.

UNHAIRING AND FLESHING KNIVES

In the experimental stage, even a kitchen knife will do, but specially made tools are preferred (Figures 15 and 16).

A BEAM

A log, which has a diameter of about 40 to 50 centimeters and which is made smooth and set at the proper angle, will do for a start. Instead of a beam, a board which is about 40 to 50 centimeters wide and rounded up on the sides can be used. Fleshing, unhairing and scudding can also be done on beams made out of stone.

ADDITIONAL EQUIPMENT

Gradually, when the beginner has mastered the technique and is sure of himself, he can acquire additional equipment, such as draining "horses," a drum, finishing and oiling tables; and he can construct brick, cement or stone vats. More detailed information is given in later chapters.



FIGURE 14. — *Glazed earthenware pots such as these magoors are profitably used by tanners in Nigeria and the Sudan.*

Basic process operations

Hides and skins of various animals, such as elephant, horse, buffalo, cow, calf, sheep, goat, pig, reptiles, birds and fish, differ in thickness and grain (Figures 5, 6, 7, 9 and 10). Some have hair or fur, and others have feathers. All are products of the epidermis. The procedure of converting them into leather remains the same. These are the principal processes:

1. The removal of undesirable parts — for example, the epidermis and hypodermis by processes called soaking, liming, unhairing, scudding and fleshing.
2. The preparation of the derma, or "true skin," for tanning by processes called soaking, liming, deliming, bating and pickling, or drenching.

These processes free the derma from epidermis and hypodermis and condition the derma. They are both chemical and mechanical. The liming which helps to soften the epidermis and prepare the derma is a chemical process; the removal of the softened epidermis with a knife is mechanical.

3. Tanning — the absorption of the tanning infusions or solutions which convert the hides and skins into leather.

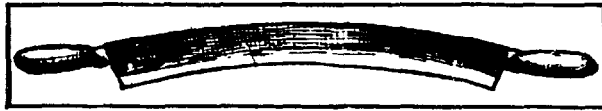

FIGURE 15. - Sketch of not very sharp unhairing knife with two handles.

Courtesy Mrs. Erica Mann

FIGURE 16. - Sketch of fleshing knife with two handles. One edge is concave and used for scraping; the other, convex, is very sharp and used for cutting.



Courtesy Mrs. Erica Mann

4. Finishing operations, such as oiling and drying, stretching, dyeing, rolling and staking, which are intended to improve the quality and appearance of the leather.

There is no short cut in the tanning processes; nor are there any compromises. Bad soaking, insufficient liming, incomplete tanning and any other neglect become exposed in the finished leather. Its quality suffers greatly if any stage is missed or imperfectly carried out.

The goods pass from one process to the next. It is necessary, therefore, to have a prepared program of work. The right receptacles and chemicals and the right amount of space must be on hand before the operations begin. Even with the smallest skin, thought must be given to each operation.

If the operator has not had any previous experience and wishes to avoid heavy losses, he should experiment with a small piece of hide or skin in a glass jar or any other available receptacle. This will often give him more useful experience than experimenting on a full vat of hides and skins. Each process can be carried out on a small scale before proceeding with proper tanning. In this way losses and disappointment will be avoided, and the basic principles of tanning will be mastered in a reasonably short time.

Since lime, sulphide, wood ash and all tanning materials may lead to dermatitis, the tanner should accustom himself to wearing rubber gloves. Lime is very alkaline. The rinsing of the hands is an elementary hygienic rule.

III. PREPARATION OF HIDES AND SKINS FOR TANNING

Soaking

Figure 17 shows schematically the processes of first converting hides into "pelts." The first step is soaking. Its purpose is:

- (a) to soften the hides or skins — especially the dried ones and those of fallen animals — so that, in touch and appearance, they resemble skins which have just been removed from freshly slaughtered animals: the fibers absorb the water lost during salting or drying and then swell to their original condition;
- (b) to remove blood, dung, earth or other impurities which were not removed during curing;
- (c) to facilitate the penetration of chemicals in later processes, thus producing the light swelling which is called plumping;
- (d) to remove salt: for salt in the hides prevents swelling and exerts an unfavorable influence on further processes.

The soaking of hides and skins, though apparently simple, presents difficulties. Like all other operations in the tannery, it requires long experience. It is not a good policy to mix different kinds of skins, for instance, sheep and goats. It is also inadvisable to mix suspension-dried with ground-dried goods because the times needed for their soaking are different. The best results are given when separate containers are used for each type of hide or skin. Soaking is quicker in warm weather, when the danger from bacterial damage is very great. In warm weather, therefore, the goods should be

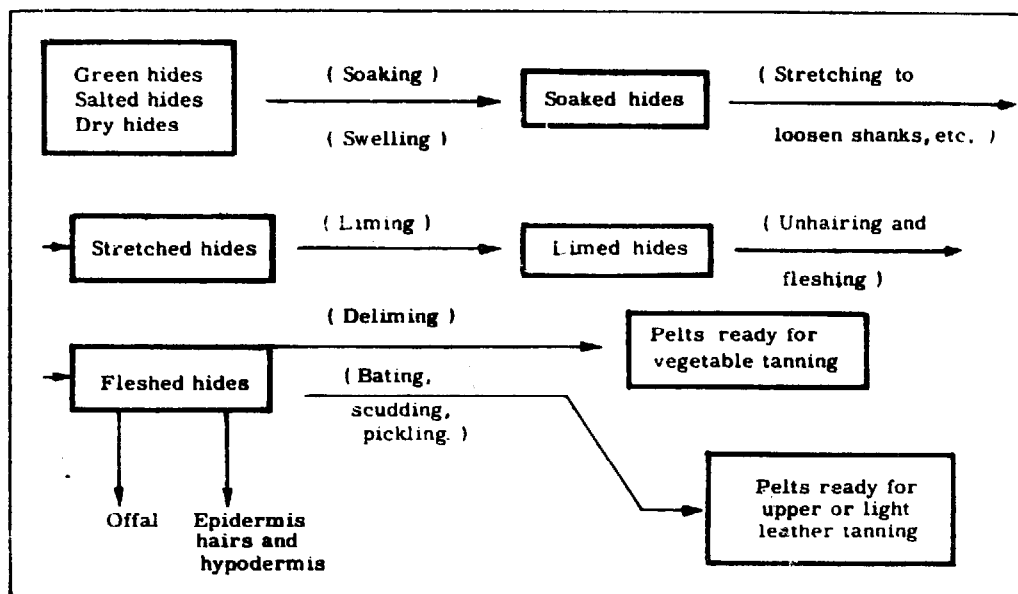

FIGURE 17. - Flow chart showing subsequent processes to convert hides into "pelts," prior to tanning process.

frequently inspected and turned. Soakwater containers must always be kept in the shade. The temperature of the soakwater should never be more than 27° to 30° C: for higher temperatures cause a decomposition of the hide. It is easy to soak properly prepared hides and skins, but material which has started to putrefy is dangerous. Once the goods are put in water, the putrefaction continues. It accelerates with increasing temperature.

It is advisable, once progress has been made, to control the soaking process by (a) keeping the water as cool as possible, and, in the hot season, by checking the temperatures; and by (b) adding a little bactericide.

GREEN HIDES AND SKINS

Hides and skins from freshly slaughtered animals are termed "green." They must reach the tannery within the shortest possible period, and certainly within a few hours. Green material need only be soaked for a short time — a good washing, in fact, is sufficient — before the next process, which is liming, begins.

WET AND DRY SALTED HIDES AND SKINS

All loose salt should be shaken off before soaking. At least, the first two soaking waters should be changed at short intervals. For the whole of the operation not less than three or four changes should be used, even after the skins or hides feel completely soft.

Dry salted hides are preserved through a combination of two processes — first by salting and then by drying. Though they are more easy to soak than hides which are directly dried, they may well require a soaking period of two days.

SUSPENSION-DRIED GOODS

Properly prepared suspension-dried goods cause less trouble than ground-dried goods. Nevertheless, it may take three days before they are uniformly soft. Fresh cool water should be used and frequently changed to prevent the development of an objectionable odor. Bleaching powder should be used as an antiseptic, whenever soaking is to last for more than a few hours. A suitable quantity of bleaching powder is between 1 to 4 kilograms per 1,000 liters of water.

The soaking of very hard hides sometimes needs mechanical or chemical assistance. Mechanical assistance, such as trampling, working over a beam, or kneading, helps the softening. So does the chemical assistance which can be obtained by adding to a good float of water 1 percent of caustic soda which is calculated on the weight of raw skins: for example, 70 kilograms of raw skins, air-dried, require 0.7 kilogram of caustic soda and 1,000 liters of water. The addition of caustic soda also causes a substantial swelling, or plumping, of the goods. To avoid damage to the hides, the caustic soda must be dissolved separately before it is added to the soaking liquid.

Under rural conditions where soda is not available, 1 kilogram of fresh wood ash, "dissolved" separately, or added before the skins are put in, may be used for every 50 liters of water.

GROUND-DRIED GOODS

The soaking of ground-dried hides and skins is difficult and often risky. In drying, they have been invariably baked on the outside, while the inside is still soft and liable to putrefaction; they will hardly

absorb water. Another factor which prevents ground-dried hides and skins from soaking easily is the subcutaneous fat. This tends to escape from its cells and to run between the fibers, so that the water cannot penetrate. It is, therefore, a bad practice to mix ground-dried goods with suspension-dried goods. They should be soaked separately. The water should be frequently inspected and changed as soon as objectionable odors indicate that putrefaction is starting. Any parts which show extensive damage in the form of holes and any smelly tissue should be cut out and thrown away, so that the putrefaction cannot spread. They must not be thrown near undamaged goods. As for suspension-dried goods, there must be a full use of chemical and mechanical assistance. During hot weather, or when hides show putrefactive patches, it is an advantage to add antiseptics, such as bleaching powder, chlorine, sulphur dioxide, sodium fluoride, sodium hypochlorite and sodium bisulphite. These antiseptics all reduce putrefactive action. The most economic among them are bleaching powder and chlorine. Carbolic acid, cresol and similar tar products must not be used because they have a slight tanning action. The cost of tanning does not justify the treating of material which will lose much of its substance during processing. Rural tanners, for one thing, will not have these chemicals easily available. The tanner should inspect all goods during soaking. He should cut out any parts which show decay. If necessary, he must reject the entire skin or hide. Thus he saves himself time, space, labor and material.

Soaking must continue until the hide or skin has been completely rehydrated or softened, particularly in the butt part (Figure 18). The softer bellies — and even the thicker, but softer, shoulders — will soak back more easily than the butt. If the goods are "broken" over the beam, more attention should be paid to the butt. On the other hand, oversoaking may involve a loss of hide substance. In consequence, there will be a thin, empty leather. It is preferable to stretch partly soaked hides over a saddled beam. This prevents any possible damage to the hide.

Green fleshing — the removal of loose meat and fatty tissue at this stage and before liming — is becoming a common practice. So long as it is done in the proper way, it can greatly help rural tanners wherever flaying is not good. It helps penetration of lime enormously.

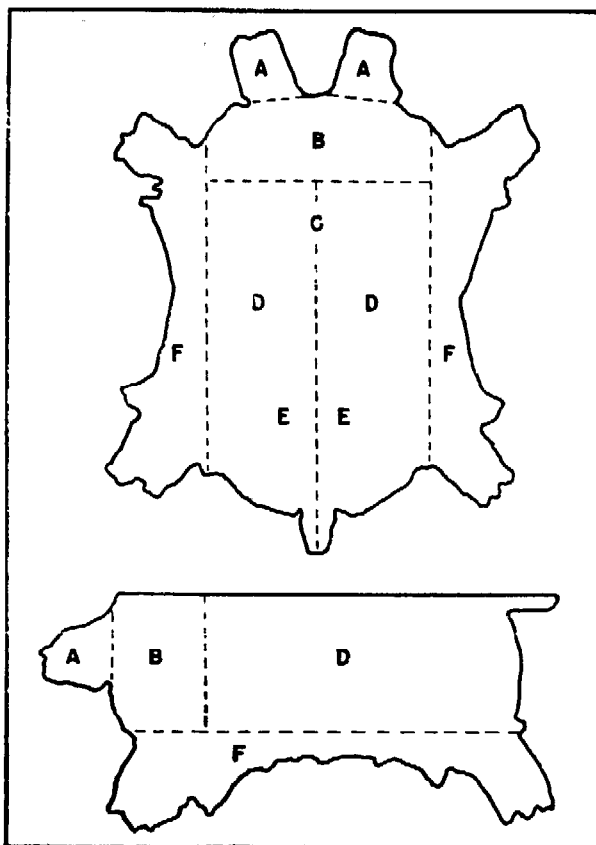

FIGURE 18. - Sketch to illustrate different parts of a hide, having various thicknesses and strengths and used for various purposes.

Courtesy Mrs. Erica Mann

- A - Cheek
- B - Shoulders
- C - Butt
- D - Bend
- E - Crop
- F - Belly

Liming

After the hides or skins have been properly soaked, they are ready for "liming." This is so called because one of the chief ingredients of the lime liquors in which hides or skins are immersed is generally milk of lime. Sodium sulphide and hydrosulphide, arsenic sulphide, ammonium salts and even enzyme products, however, are all used in different liming processes.

Wool can be removed by fellmongering, and hair by sweating. Wool sheepskins are invariably fellmongered before liming proper. "Fellmongering" is pasting, or painting, with a fiber brush the flesh side with a mixture of slaked lime and sodium sulphide. The wool is pulled off after the skins have been piled overnight, flesh side to flesh side. The mixture is approximately a 10 percent solution of solid sodium sulphide (fused, containing 60 percent) which becomes about 5 percent by dilution with the lime paste. As an example,

the following mixture is given: 6 kilograms of hydrated lime, 0.5 kilogram of sodium sulphide, 10 liters of water.

In "sweating," the wet hides are piled one on top of the other, or they are hung in a hot and humid room to encourage the bacterial action which loosens the hair. This treatment is difficult to control, and it often damages the grain; it should not be encouraged. Whatever method is used for unhairing, the hide or skin must still be limed to destroy or loosen the epidermis, for this layer keeps the hair or wool attached to the skin. Liming also conditions the derma by removing the "cementing material" — for example, the nonfibrous proteins and mucins which bond and lubricate the fibers. It is far better for the rural tanner to save himself the expense of fellmongering or sweating and to dehair during the essential process of liming.

Lime is made by burning alternate layers of limestone and firewood in special kilns (Figure 19). The product thus obtained is called burnt lime, or quicklime.

If the burnt lime is added to a tub of water, a violent reaction occurs and the burnt lime is converted into a paste called slaked lime. This may be used in tanneries; it is often dried to a powder and sold in bags as hydrated lime.

Figure 20 shows a correct and simple way of slaking lime. The iron drum is two-thirds filled with water at about 60° C. The fresh quicklime is added, and the mixture is well stirred. The temperature rises and the heat developed in the slaking process brings the mixture to the boil, thus producing slaked lime in a very finely divided state. Lime slaked in this manner yields a finer suspension than that slaked in cold water. It allows more lime particles to settle between each hide or skin. The result is a more efficient liming.

The aim of liming is:

- (a) to destroy or soften the epidermis whereby the hair or wool is loosened;
- (b) to destroy sweat glands, nerves, veins and blood vessels in the hide substance;
- (c) to soften and destroy the reticular (interfibrillary) tissues which keep the fibrils together, and to open and plump the fibers and fibrils to facilitate penetration of the tanning materials;
- (d) to cause swelling and plumping of loose meat and connective tissues on the flesh side and to facilitate its subsequent removal.

FIGURE 19. - *View of simple lime kiln. Limestone from local deposits is fired by coal and produces a quality of quicklime suitable for building purposes and for use by tanners.*

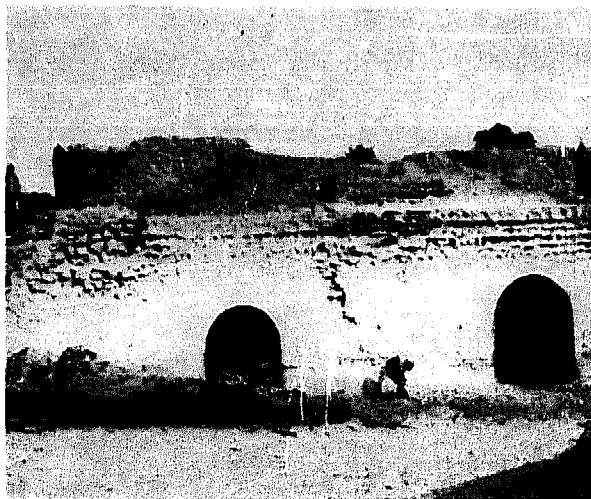

Lime is only slightly soluble in water. Not more than 13 parts of lime can be dissolved in 10,000 parts of water (25° C.). Thus no damage is done to hides and skins by using excessive lime, for it remains undissolved at the bottom of the vat. Gradually, as the skins take up the lime from the water, more lime is taken up by the water itself.

Three types of lime liquors are used in a tannery:

Fresh lime. This liquor is prepared by slaking a weighed quantity of burnt lime separately and adding the required amount of water.



FIGURE 20. - *Slaked lime can be made correctly in iron drums.*

Its concentration can be from 1 to 4 kilograms in 100 liters of water. If it is necessary to strengthen the liquor in a vat, the lime must be slaked first to avoid damage and burns to the skins during the slaking process. Thus strengthening the liquors is done by adding the required amount of the lime which has been slaked separately.

Mellow lime. After one or two packs of hides have passed through fresh lime, it is said to be mellow. This is a lime liquor with mellow or mild action: it is not so caustic as fresh lime, and it causes less plumping. None the less, it attacks the epidermis more vigorously than does fresh lime. Thereby it loosens the hair more rapidly.

Old lime. Lime which has been used many times and has lost its causticity is called old lime. It has feebler plumping powers, but its hair-loosening effect is invariably greater than that of mellow lime liquor. When very old lime smells of ammonia, it is dangerous to use; it should be thrown away.

There are two methods by which fresh, mellow and old limes may be used — the one-pit system and the three-pit system. Both these methods can be used for any type of leather, so long as there is the right degree of mellowness. As a rule, however, sole leather should be limed in fresher limes than those normally used for skins. The goods should be moved once a day and laid flat on the side of the vat. The lime liquor is then vigorously stirred. When the goods are put back, they should be again laid flat, hair side up, before the lime has settled. This prevents the lime content of the liquor from falling as the skins take up lime.

THE ONE-PIT SYSTEM

Used lime liquor is strengthened by adding fresh slaked lime, and the hides are immersed for three days. On the third day, they are removed, and fresh slaked lime is added. After another three days all the lime liquor is removed, and a completely new liquor is prepared from fresh slaked lime. When the hides have been immersed for four days in this new liquor, they are taken out for unhairing. The liquor is then used to start a new batch of hides. The whole process, which takes ten days, is used for thick hides to produce sole leather, harness, and similar types of leather.

To achieve an even and rapid liming, it is advisable to draw the goods out of the vat once, or even twice, every day, to pile them on the rim and then to return them to the lime.

THE THREE-PIT SYSTEM (Figure 21)

Three vats are used. Vat No. 1 contains old lime — that is, lime already used twice. Vat No. 2 contains mellow lime — that is, lime used only once. Vat No. 3 contains fresh lime.

The liming starts in Vat No. 1 and in old lime. The hides are immersed for four days. They are then transferred to Vat No. 2 and to mellow lime for three days. The last treatment is given in Vat No. 3 in fresh lime for three days. There is a daily haul.

When hides have passed through the three vats, the liquor will have changed. The fresh lime will be mellow, and the mellow lime will be old. The old lime will be of no further use and should be thrown away. A further supply of fresh lime will then be made in the empty vat. The vats will then contain the following liquors:

Vat 1 - fresh lime

Vat 2 - old lime

Vat 3 - mellow lime

A new pack of hides, therefore, will be immersed in the vats in the following order:

Vat 2 - old lime

Vat 3 - mellow lime

Vat 1 - fresh lime

The position will change again. The old lime in Vat 2 will be discarded, and this vat will be used for making fresh lime. The order of immersion will then be as follows:

Vat 3 - old lime

Vat 1 - mellow lime

Vat 2 - fresh lime

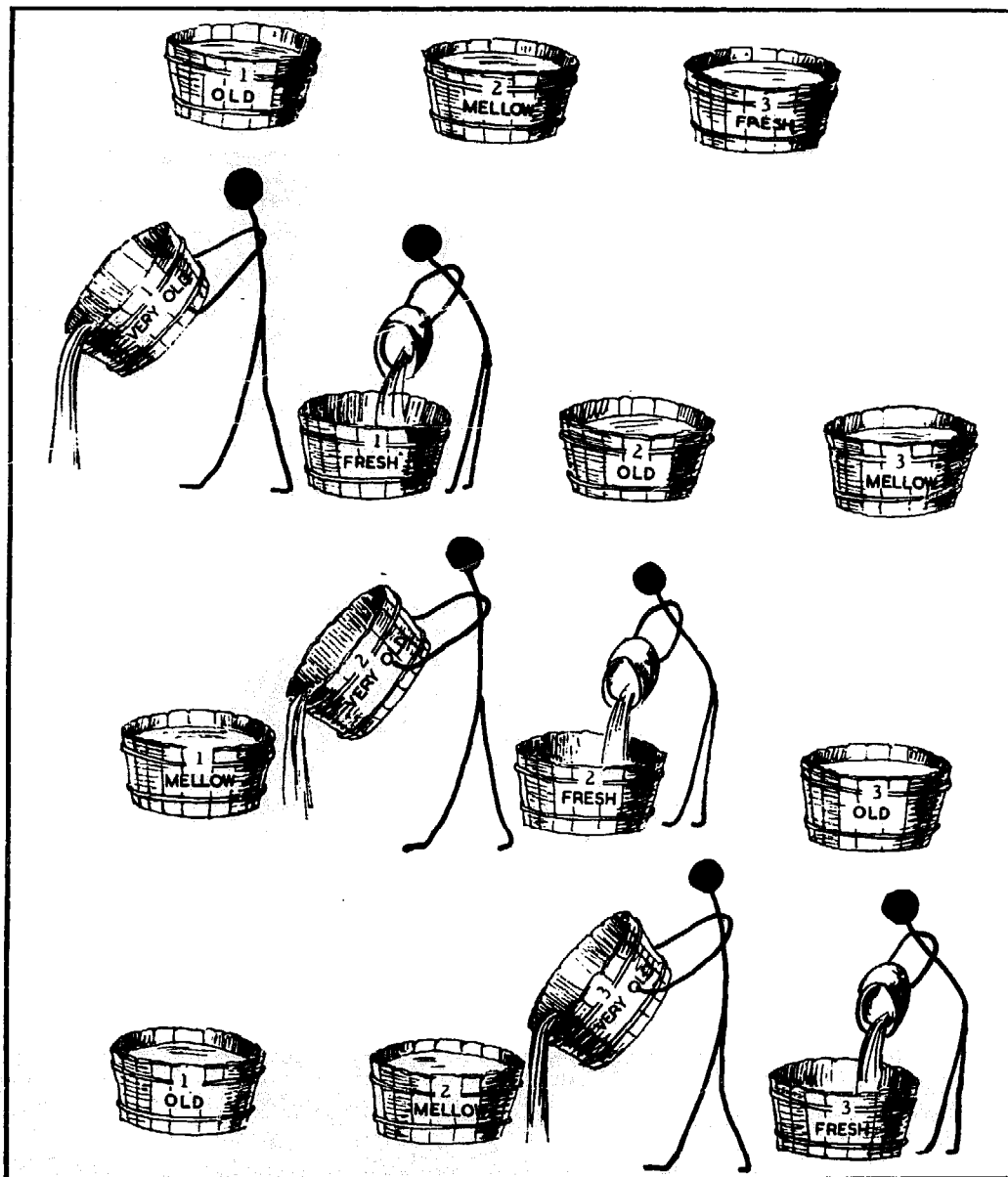

FIGURE 21. - Schematic sketch showing use of lime in so-called "three-pit system."

Courtesy Mrs. Erica Mann

Different goods require different times in liming before they are ready for unhairing. The correct moment is determined by rubbing the thumb against the lie of the hair. When the hair can be rubbed cleanly off the surface, the goods are ready.

To avoid loss of hide substance, it may be desirable in hot areas to reduce the period of liming, for example one or two days in Vat No. 1, and two days in Vats Nos. 2 and 3 respectively.

After the unhairing, if it has been done by pasting with lime-sulphide paint, it is necessary to lime in fresh lime liquor for about a week. The actual period varies. Goatskins, for example, may be ready for unhairing after a week in lime; yet they may require a further liming after unhairing (Figure 22).

In certain parts of the world, unhairing is done by means of wood ashes. They are mixed with plenty of water, and the skins are immersed in the mixture. After several days — the time depends on the weather and the type of wood from which the ashes are made — the hair becomes loose and can be removed easily. Besides their unhairing qualities, certain ashes have some of the properties of lime liquors.

Smearing the skins with cattle dung or burying them in the earth to remove the hair is very dangerous. It causes hairslip, which is an early stage of putrefaction. The hair of the thin parts, such as the bellies, will become loose, while the hair on the neck and shoulders remains firm. This method must be condemned.

Unhairing, fleshing and scudding

It has already been explained that the epidermis and hypodermis must be removed before the pelt, or corium, is converted into leather. At this stage, the tanner must take the following action:

- (a) Unhairing — the removal of the hair after liming. In some instances, it should be realized, unhairing takes place in the early stages of liming, while further liming takes place after unhairing.
- (b) Fleshing — the cutting off of the loose meat and fatty material which is called the hypodermis or, colloquially, “meat” or “flesh.”
- (c) Scudding — scraping off the epidermis as well as the hair roots, glands and lime soaps.

UNHAIRING

After liming, the hair is loose and can be scraped off easily. This is done with an unhairing knife, which is a two-handled knife curved to fit the beam. The blade is not very sharp; for unhairing is a scraping, rather than a cutting, process (Figure 15).



FIGURE 22. - *Liming vats and workers unhairing on beams.*

Courtesy Kenya Information Office, Nairobi

The unhairing, and also the fleshing and the scudding, operations are performed on a sloping convex table called a beam, the top of which forms an arc. The table is set at an angle of 40 degrees. One end rests on the floor. The other is supported by a kind of leg, so that the top reaches to the waist of the operator (Figures 23 and 24). The skin is laid flat without wrinkles on the beam, hair side up, and the hairs are removed by pushing the knife in the direction of hair growth until a clean grain is visible.

FLESHING

The lime has also caused a plumping of the hypodermis, which is now thick and flabby and can easily be cut off. The removal of the hypodermis is called "fleshing." The knife used for this operation has a very sharp convex outer edge for cutting and slicing, while the inner concave blunt edge is used for scraping and for moving skin or hide round the beam (Figure 16). If these knives are not available, sharpened unhairing knives may be used.

The fleshing knife is used in sweeping movements to slice off any loose pieces. This must be done carefully to avoid cutting into the corium while removing the entire hypodermis. The corium should be left completely smooth, clean and uncut.

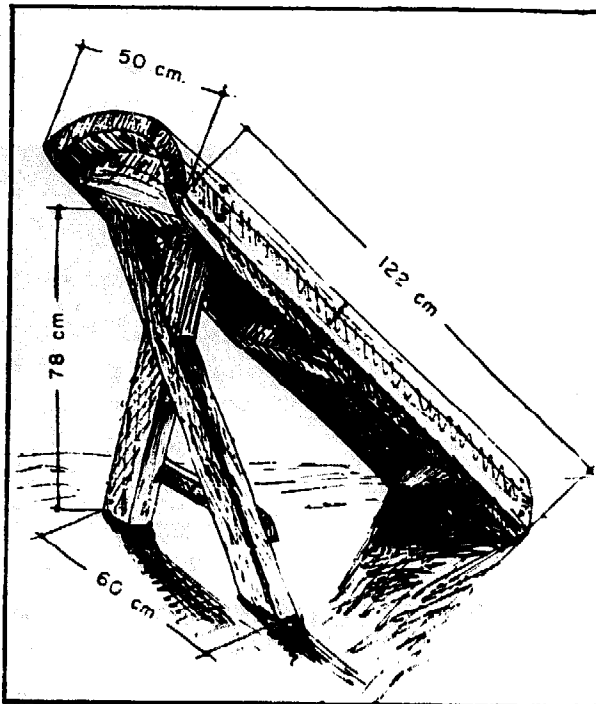

FIGURE 23. - *Sketch of locally constructed beam as used in processes of unhairing, fleshing and scudding.*

Courtesy Mrs. Erica Mann



FIGURE 24. - *Unhairing, as well as fleshing and scudding operations are performed on a beam. For special purposes, scudding is still done manually even in modern tanneries. Photo shows operator de-wooling sheepskin after painting.*

Courtesy Marocchinerie e Scamoscerie Italiane, Turin

SCUDDING

The hides and skins, when unhaired and fleshed, are then put back into the lime, or limey water, for a further softening of the epidermis. After one day in the lime, they are taken out, put over a beam and scudded.

The skin is laid completely flat and smooth on the beam, grain side up. The operator, as he pushes the blunt knife downwards in the direction of the lay of any remaining hair, needs to use only moderate pressure to squeeze out the hair follicles, glands and dirt.

To obtain a clean surface it is essential to squeeze the smallest hair from the pores. Scudding is a most important action: it must be repeated many times if perfect leather is to be made.

Scudding can be performed not only after liming; it can also be repeated after bating and drenching. These two processes are described later. Even in modern tanneries, scudding for special purposes (Figure 24) is still done by hand: for the skilled worker knows exactly how to adjust the pressure and the angle of the knife and how to maintain that blunt, smooth edge which achieves the best results.

Water vats are often used in the intervals between unhairing, fleshing, scudding and bating.

Rounding and trimming

Rounding is the term for so cutting up the hides usually intended for sole leather that the different parts are tanned separately, and then used, according to their quality and thickness.

Hides are not uniform in fiber structure, substance, nor in thickness. In consequence, it is desirable to divide the hides into three main sections. These are (a) the butt, or center part, which consists of two bends, one each side of the spine; (b) the two bellies; and (c) the shoulder and neck (cheek, face).

These portions are generally used for different purposes (Figure 18). Sole leather is produced from the butt, which requires the longest tanning. The bellies are much thinner. They are normally used for insoles, slipper soles and similar types of leather which need a shorter tanning process.

The shoulders are used for lighter soles, straps or insoles. They represent another type of material, and they are tanned accordingly.

The rounding procedure requires a flat table about 120 centimeters by 180 centimeters in size and a rather heavy type of knife similar to that used for pruning. The hides are folded, grains side out down the back, and lifted on to the table from the neck and tail ends. This is usually done with iron hooks. The rounder's skill is important when he selects the line where he should cut: for it is undesirable to have belly and shoulder pelt attached to the more expensive butt. A reduced butt is also uneconomic. For these reasons, the rounder presses the thin flanks of the pelt with his fingers. In this way he finds the line for the removal of both bellies with one cut. As a rule, the shoulder is removed at a point immediately above the withers, or just behind the hump.

This method of rounding, however, concerns only the more advanced tanners. Later chapters explain that the rural tanner has few vats and must economize in their use. For the rounding of hides for sole leather, therefore, he should follow the simple process of cutting in halves from tail to neck along the ridge of the back.

Cutting, as Figures 25 and 26 show, is best done on a horse. This is made very simply from cut timber. A central groove is cut along its entire length to a depth of about 5 to 6 centimeters, and this allows the knife to move freely during the cutting operation. Two parallel boards will also serve for this purpose if they are fixed 1 centimeter apart.

Trimming is the removal of uneconomic edges, pieces of flesh, and so on.

Deliming, puering and bating

When the epidermis and the hypodermis have been removed, the limed hides and skins are submitted to a deliming process. This means the removal of lime or alkalinity from the hide or skin. Whether the removal is partial or complete depends on the type of leather to be produced.

Limed hides and skins are rendered soft and fallen — a condition termed "flaccid" — by the complete removal of their lime content.

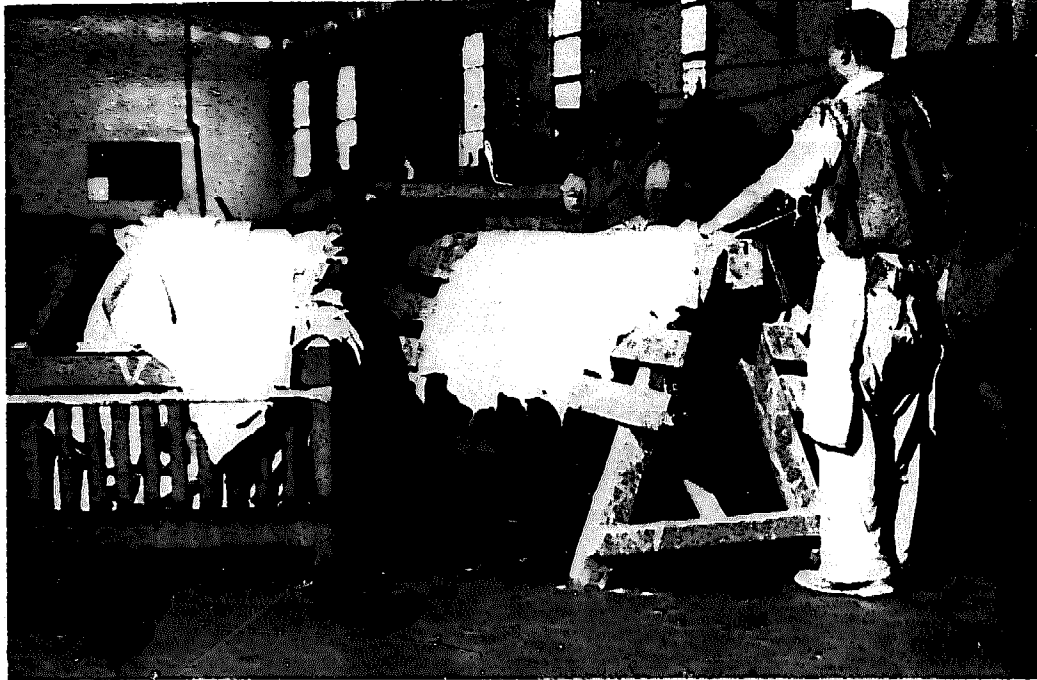

FIGURE 25. - *Wooden horses made of locally available timber, used to cut hide into sides, and number of other purposes such as draining, piling, dyeing or display of finished product.* Courtesy Kenya Information Office, Nairobi

FIGURE 26. - *Detail of cutting operation on hide.* Courtesy Kenya Information Office, Nairobi



A softer leather is obtained from these fallen pelts than from pelts which have been only surface-treated — for example, partly delimed. Unless the lime is removed, the finished leather will be hard; the grain will be brittle and discolored. One method of producing a firmer leather, however, is to leave one third, or two thirds, of the lime in the interior of the pelt as it passes into the tanning process. This is particularly true of sole leather manufacture.

A certain degree of stretch, suppleness and smoothness is desired in shoe upper, gloving, clothing and other light leathers. It cannot be achieved by mere deliming. Stretch or “run” — for instance, in gloving — is obtained by puering or bating. Puering is the treatment of pelts with a warm infusion of dog dung (puer). Bating is a similar process; but here the puer is replaced by hen or pigeon dung, or else by a synthetically produced material, such as the patented Pancreol, Peroly, Cutrilin, Enzo, Oropon, and other similar products. The manufacturers issue instructions on their use. The aim of this paper, however, is to instruct and to guide rural tanners in the use of raw materials which are cheap and readily available in their own locality.

Synthetic bating is a treatment of the skin with a commercially prepared bate made of animal pancreas. This is a gland which produces digestive juices, and it is combined with a delimiting agent, such as ammonium chloride.

The actions of puering and bating are similar, but puering is more drastic. It is very important to control the pH value¹ in the puering process. The optimum for tryptic activity is from pH 7.5 to 8.5.

The object of puering or bating is to make the skins ready for the production of soft, smooth and pliable leather. Skins out of the limes are usually plump, and when they are tanned in that condition, they produce firm leather. To ensure a soft pliable leather, however, all plumpness must be removed.

According to an old tanners' proverb, a lambskin cannot pass through a bracelet before puering or bating, but it will readily pass through a wedding ring after one or the other process. The proverb clearly illustrates the action of “falling,” for it is the opposite of “plumping,” or the swelling caused by the liming process.

¹ See Appendix on “pH Value in Tanning.”

DELIMING

Not all the lime is removed by washing limed pelts in running water; and, in any event, it is a prolonged treatment. When vats or pots are used for this process, there must be several changes of water. Trampling the skins with the feet, or wringing by hand, certainly speeds up the washing, but repeated washing under running water and working over a beam with a blunt knife play the major parts in squeezing lime out of the pelt. Sixty percent of lime can be removed by washing, and this is an important economic factor. None the less, the removal of all the lime by water alone is impossible. Prolonged washing may damage the skin or hide mechanically. A light deliming — the use of some acid, followed by puering or bating — removes all caustic lime completely. This method is, therefore, preferable. Complete deliming can also be achieved by ammonium chloride as well as by acid; and it is safer.

Because the effects of puering or bating are very similar, "bating" is now the term used for either process.

PUERING AND BATING

The process of puering is as follows. A paste of 10 percent dog manure in warm water is prepared in a wooden or earthenware utensil, and it is kept unexposed to the air for about a week. It is then thoroughly stirred, passed through a bag, sieve or screen to remove coarse particles and put into a vat of lukewarm water (29°-34° C.). The skins are completely immersed in this solution, which is stirred continuously. The water must not become cold. From time to time, therefore, more warm water is added, or else the whole process is conducted in the sun. As a rule, bating by this method is completed in one or two hours.

Pigeon bate is prepared from 1 kilogram of manure stirred into 100 liters of water, which is heated to 43° C. It is allowed to ferment for at least a week. After this fermentation, the temperature of the bate is raised to 32°-35° C. by adding 200 liters of warm water. It is customary to filter the bate before adding the water. With cold bate the bating may take up to seven hours; but if the bate is kept consistently warm the process can be reduced to about three hours.

The time taken for the bating operation varies, and it is necessary to make periodical tests. This is done by gathering the skin into the form of a bag which contains some of the bating liquor and air. The bag is then squeezed. If the air passes through the pores of the skin, bating is complete. If not, bating should continue.

Another test is to press the thumb firmly against the grain side of the skin. If the thumb impression remains, bating is complete. Only leather which is to be soft should be bated. The grain of bated skins feels very soft and the hair holes remain clearly visible. When properly bated skins are dropped on to a table, they are flaccid — that is, soft and slippery to the touch — and the folds remain close together.

After bating, the goods are scudded again. This is a treatment of the grain side of the pelt with a blunt knife or slate blade. It is done to squeeze out any small particles — called “pigment” or “scud” — which became loose during the bating operation. The skins are then washed in water before they are tanned. A small amount of boric acid is added to the water to ensure neutrality.

Dog or pigeon dung is unpleasant to use and difficult to control. In recent times, it has been replaced by pancreatic juice or minced pancreas.

The pancreas, which the butchers call the “stomach sweetbread,” is a gland situated near the liver and the duodenum (Figure 27). It produces juices able to digest meat in the same way that the salivary glands, for instance, produce saliva able to digest starches. This gland is of irregular shape; it has a creamy or reddish color; and it weighs approximately 280 to 340 grams in the ox and 85 to 110 grams in the pig. Ox pancreas juice is weak; goat and sheep pancreas is of medium strength; and pig pancreas is the strongest.

The preparation of minced pancreas for bating purposes is a simple procedure. The gland should be removed from freshly killed animals and, without any previous washing, it should be minced in a meat-mincing machine. As the juices are the most important part of the gland, they should not be lost during the process. Instead, the whole amount should be collected into a pan or plate. If the bate is required at once the pancreas is minced; and to three parts of the pancreas seven parts of ammonium chloride are added. The bating is done by using 3 percent of the pancreas-ammonium chloride mixture calculated on the wet weight of the hides.



FIGURE 27. — Sketch showing position of ox pancreas in relation to liver, duodenum and gall bladder.

Courtesy Mrs. Erica Mann

These proportions are for pig pancreas. If goat or sheep pancreas is used, then 50 percent more will be necessary. If ox pancreas is used, the quantity should be doubled. Good results are obtained by mixing two kinds of pancreas — for example, one third pig and two thirds cattle; or one third pig and two thirds sheep.

A steady supply of fresh pancreas is rarely available. The glands, therefore, should be preserved. The cheapest and most efficient method of preserving them is to grind equal parts of fine clean dried sawdust with the pancreas. The mincing should be repeated twice until a homogenous material is obtained. The material should then be placed on a flat tray and exposed to the sun. By continuous turning and mixing it is possible to dry the mass very rapidly. The temperature should not exceed 43° C.; otherwise the bate loses its active properties. Drying in an oven or over a fire renders the bate entirely useless. Once the mixture is completely dry, the addition of 33 percent of ammonium chloride produces a bating material which is long lasting, handy, cheap and clean to use. The beginner, however, finds the preparation of the bate difficult.

The amount of bate which should be used depends on the type of skin, but, as a rule, it does not exceed 0.5 percent of the weight of the pelt. It is always used in water at a temperature of 32° to 35° C. Stirring or paddling greatly assists bating.

Drenching and pickling

Two additional processes are called drenching and pickling. Either may be used after bating to ensure that the pelts enter the tanning liquors in a slightly acid condition. They need not both be used. The rural tanner, however, may find it advantageous to drench after delimiting and/or to bate the skins before vegetable tanning. As a rule, pickling is done after bating and before chrome tanning.

DRENCHING

Often an ordinary acid delimiting process is described as drenching; it is sometimes called "acid drenching." The real drenching process is one in which the puered or bated pelts are subjected to the action of an infusion of bran or similar substance. The process of drenching is important where natural puers are used. The bran acts as a mechanical "scrubber;" it cleans the dirt brought by the puer from the skin. With pancreatic bates a pickle suffices. The term "drenching" or "acid drenching" is a misnomer; and this is probably due to the frequent substitution of an acid delimiting process for a bran drench. In this paper, soaking the skins in a fermented infusion of bran (or flour) and warm water is called drenching, the fermented material is called a drench.

The objects of drenching are:

- (a) to continue and to complete the removal of lime which began in the washing, puering or bating process;
- (b) to assist in removing the last remnants of the scud, and any mucoid material which is left after the liming, and to make a whiter and clearer leather;
- (c) to change the reaction of the pelt from slightly alkaline to feebly acid;
- (d) to cleanse mechanically the grain of the pelt.

Even when a thorough washing has been followed by bating, some lime may still remain in the pelt. This can be removed by chemical agents.

In commercial tanneries lined pelts are neutralized, and boric, hydrochloric, lactic or acetic acid are normally used. In rural regions it is possible, instead of buying acids, to make them by fermenting the brans of maize, wheat or rice. Any other fermentable cheap material can also be used. Flour, too, can be used, but it is expensive.

The drench is prepared by pouring hot water over bran and by leaving the mixture overnight in a covered vessel and in a warm room. The amount of bran which is needed is calculated on the weight of the skin to be drenched. As a rule, 5 to 10 percent is sufficient — for example, 0.5 to 1 kilogram of bran for 10 kilograms of wet skin. There must be enough warm water to cover the bran and the skins. The skins are stirred occasionally, and they may be weighted down in the drench with stones to prevent their rising to the top. After 24 hours, the process is complete. Keeping the skins in the drench for too long may cause "blister." Therefore, they must be examined periodically.

In certain countries — for example, in the Sudan — small green pods of acacia are used. They are put into warm water and left until some acid is formed by leaching and fermentation. This acid is sufficient for deliming. There are probably many other plants which could be used in this way. They are worth investigating.

To determine when deliming is complete, an indicator is essential. An indicator is a substance which changes color by the action of acid or alkali. The tanner must be acquainted with at least one indicator. Phenol phthalein is, perhaps, the most useful.

If phenol phthalein or any other indicator is unobtainable, the rural tanner may use the green coloring matter from leaves which is called chlorophyll. It gives a well-defined color change with acid and alkali. The coloring matter obtained from mashed tomato leaves also gives excellent results.

A standard solution of phenol phthalein is made by dissolving 1 gram of the solid material in 500 cubic centimeters of strong alcohol; and when the phenol phthalein is dissolved, the solution is diluted with 500 cubic centimeters of distilled water. This stock solution should be poured as required into a small bottle which, like a bottle used for eye drops, is fitted with a rubber teated pipette. The pipette can then be used to deliver one drop at a time (Figure 28).



FIGURE 28. - *Sketch of small bottle fitted with rubber-tipped pipette (as used for eyedrops) containing standard solution of phenol phthalein.*

Courtesy Mrs. Erica Mann

One drop of phenol phthalein solution on the freshly cut section of the hide or skin will give either:

- (a) a colorless reaction, which indicates that no alkalinity — for example, no lime — is present; or
- (b) a pale pink reaction, which shows that a little alkalinity is left; or else
- (c) a bright red reaction, which shows that much caustic lime remains.

Thus, when the indicator remains colorless, the skins are ready for tanning. When the phenol phthalein turns pink, the skins should remain a little longer in the drench and then be tested again. But when the bright red color remains, it means that nearly all the lime is still present, and probably:

- (a) the skins were not properly washed before they were placed in the drench; or
- (b) the drench did not ferment because it was kept too cold; or else
- (c) too many skins were used for the amount of drench.

For sole leather, complete deliming of hides should not be attempted because this would give a softer leather and make it too light. As a rule, 0.5 percent of boric acid solution used overnight is sufficient deliming for the previously washed hides. If a drench is used, the hide should be immersed for four to six hours to delime both surfaces only.

When these hides are being tested, the cut section will expose the center where lime is still present. Thus the center will give a bright red color with phenol phthalein, while the outside gives a colorless or pale pink reaction.

Drenching, it must be realized, can cause much loss of skin substance by the action of liquefying organisms. If possible, it is safer to dispense with it.

PICKLING

The treatment of limed, bated and scudded pelts with a solution of salt and acid is called pickling.

The rural tanner is not likely to pickle skins. This section, however, is included for the benefit of more advanced tanners and for making others familiar with terms and processing techniques which they may encounter later.

Originally the pickling process was applied to pelts to preserve them for transport within the country, or for export. Pickling the pelts before tanning, it was observed, facilitated the penetration of the tanning agents. Thus it speeded up the tanning process.

As a rule, pelts are pickled before chrome tanning. This prevents too rapid a fixation of chromium and ensures an even penetration of the chromium salts. Once penetration is complete, the pH is raised by adding alkali and the chromium salts are fixed.²

The amount of chemicals and water used in relation to the quantity of the skin which is treated must be carefully regulated. The quantity of skin is measured by weighing in the limed or bated condition, after fleshing or scudding respectively. The limed weight is about 40 percent greater than the bated weight. This is because of its water-swollen condition, for which allowance must be made.

Fundamentally, the amount of acid should be based on the weight

² See Appendix on "pH Value in Tanning."

of the skins — for example, 1 percent on the limed flesh weight, or 1.4 percent of the bated weight — for its basic purpose is to sour, or to acidify, the skin.

The amount of salt which is used should be based on the amount of water in the pickling bath. If the salt content falls very much below 4 percent on the volume of water (specific gravity 1.028), the acid will cause the skins to swell, and the structure will be weakened. This is prevented by a correct concentration of salt, i.e., not below 4 percent.

As a rule, the skins are immersed in a solution which contains the acid and salt. Normally the solution contains sulphuric acid (of 66 percent strength) and common salt.

The usual method employed for export or storage is based on the weight of the limed skins after unhairing and fleshing. The proportions are 200 percent cold water, with 20 percent common salt (sodium chloride) and 1.5 to 2 percent sulphuric acid. That is, for every 50 kilograms of pelt one requires 100 liters of water, 10 kilograms of salt and 1 kilogram of acid. Immersion should last from four to six hours whenever there is mechanical agitation such as drumming. When the agitation is done by hand, the immersion must continue for a proportionately longer period of time.

For paddling, the quantities are in the proportion of 250 liters of water, 25 kilograms of salt and 2.5 kilograms of acid for 50 kilograms of pelt. Paddling is for 12 to 18 hours; for this gives the pelts plenty of time to get into equilibrium with the pickle liquor. These quantities are right for the rural tanner when he uses a vat without any mechanical means of agitation.

Pickling before chrome tanning should be fairly heavy to ensure

Pickling before chrome tanning should be fairly heavy to ensure the penetration of the chromium salt. A useful drum mixture based on the pelt weight of the goods may be 1 percent acid, 8-10 percent salt and 70 percent cold water. The drumming should last for two hours.

After sufficient pickling, the pelts needed for storage or export should be drained on a well-covered up horse. Then they should be rolled into bundles — half a dozen pelts in each bundle — and packed in large and well-cleaned barrels. For this purpose, wine barrels are very useful. The pelts can be preserved for a year or two, if they are protected from contact with water. If, however, a further precaution against mold and bacterial action is needed, fungicides and disinfectants such as para-nitro-phenol, beta-naphthol

or santobrite in the proportion of 1 part to 1,000 should be added to the pickle solution. As a fungicide, 0.5 percent beta-naphthol is very effective.

In Europe, it is a common practice to vegetable tan pickled sheepskin in the pickled condition. If the skins are greasy, they are drummed with half their weight of paraffin for two hours. Then they are rinsed in a 5 percent salt solution. Afterwards they are well drained and drummed in 200 percent water and 8 percent salt; and the tan is added directly to the liquor. As a rule, sulphited mimosa extract is used to give 20 percent actual tan. In five to six hours, penetration is complete. All percentages are on the pickled weight.

The skins are then piled, washed off and drummed in 3 to 5 percent sulphonated oil. This gives a pale and even colored tannage. The method can be used just as well with other tanning materials, so long as they are available in a concentrated form — for example, quebracho or myrobalan extract, gambier, or even leaf sumac or tara powder.

The tannage is rapid. It is essential, therefore, to keep the skins agitated, either in the drum or by paddle, or else by other means. Wooden or acid resistant containers must be used. This method is simple, quick and economic in tan.

If traces of iron are present, the leather may suffer from tenderness after a long storage. To counteract this, whitening or powdered chalk can be incorporated after tannage.

An alternative method is to depickle the skins before tannage to neutralize the pickling acid. This is done by working the skins in a 5 percent salt solution with an addition of 1 to 2 percent — on the pickled weight of the skins — of mild alkali: for example, borax, sodium bicarbonate, soda ash, wood ash or sodium thiosulphate (hypo). The skins should finish at pH 5.0 — that is, when they have lost their sour taste. The process is not easy to carry out because the color and grain quality of the leather is very sensitive to the finishing pH. At least five hours — or, for preference, the whole night — are needed.

One of the cheapest depicklers is sodium thiosulphate (hypo). This is quite neutral, and it does no harm when it is used in excess. When, however, hypo is used, sulphur is deposited in the skin, and this is not always desirable. Moreover, sulphurous acid is liberated in the skin, which is still fairly acid.

When all these preliminary operations are over, the prepared hide or skin is white, clean, smooth-grained and free of flesh. The fibrils are separated from each other; and the true derma — the pelt — is ready for tanning.

The pelt may be converted into leather by any one of three types of tanning:

- (a) vegetable — using tannins derived from the vegetable kingdom, such as barks, leaves, roots or pods;
- (b) mineral — using chemicals such as chromium, alum, iron salts or formaldehyde;
- (c) oil — using oils derived from animal or vegetable sources; marine oils such as cod oil, however, are preferable.

IV. VEGETABLE TANNING MATERIALS

General

Tannins are bitter substances present in barks, fruits, pods, leaves, roots or seeds. They are used to convert hides and skins into leather. They come from plant sources, and they are called vegetable tannins. They have different origins, however, and they differ in strength and in character, color, concentration and quality. Thus they produce leathers of different types — hard, soft, light colored, dark colored, heavy or light. These tannins can be used singly or in various combinations to produce different effects.

Although tanning materials are found in all parts of the world, only those which are of commercial importance and are widely used in commercial tanneries — and are thus suitable for rural tanneries — are mentioned in this chapter.

Black wattle, also called *mimosa*, is marketed as a bark which has an average of 35 percent tannin, or else as a solid extract of 63 percent tannin. The wattle originates from Australia. It is extensively cultivated in the Union of South Africa and in Southern Rhodesia; and India has started a planting program. It is also used for dyeing fishing nets, ropes and sails in the Philippines and in other parts of the world. The solution is highly astringent.

Camachile is the bark of the camachile tree (*Pithecolobium dulce*) which grows in Mexico, the Philippines, and southern India. It has about 25 percent tannin.

Chestnut comes from the wood of the chestnut tree in Europe and the United States. It is used principally as a liquid extract (35 percent tannin) or as a powder (70 percent tannin). It gives a firm leather of dark reddish color.

Cutch comes mostly in the form of an extract and is derived from several kinds of acacia (*Acacia catechu*) which grow in India and in Burma. It contains between 35 and 55 percent tannin. It is astringent and produces a dark reddish brown leather. It is also used to dye fishing nets and sails.

Divi-divi comes from the podlike fruit of a small tree (*Caesalpinia coriaria*) which is indigenous to India, South and Central America. These fruits contain tannins up to some 45 percent. *Divi-divi* is mellow and yields a pale-colored soft leather. It is useful in the early stages of sole leather tanning; for it contains a sugary material which can ferment to form acid.

Gambier is an extract prepared from the leaves and the young twigs of a shrub (*Nauclea gambir*) which grows in Indonesia. It contains up to 40 percent tannin. It is very mellow and it gives a buff-colored leather which discolors when it is exposed to light. *Gambier* is generally used in combination with more astringent tannins to increase the tensile strength of the leather.

Hemlock is the bark of the hemlock tree (*Tsuga canadensis*) which grows in the United States and in Canada. It gives a red tan and is astringent.

Nut-galls or *oak-galls* are produced by the response of the tree to the action of a wasp which has pierced the young branch or leaf. They contain up to 60 percent tannin and the solution is mellow.

Mallet bark has up to 45 percent tannin, and it comes from the eucalyptus tree (*Eucalyptus* sp.) which grows in Australia. Only the inner layer of the bark is used. The solution is fairly astringent.

Mangrove is the bark of the mangrove tree (*Rhizophora* sp.) which grows in the lagoons or tidal swamps of tropical seas. It contains 35 percent tannin and gives a reddish brown firm leather. It is also sold as an extract containing 62 percent tannin. The solution is very astringent.

Myrobalan comes from the fruit (nut) of a tree (*Terminalia chebula*) which is indigenous to India; it contains from 30 to 40 percent tannin.

of the pith the tanners separate the pulp which is used for tanning. Usually the pulp is not dried separately. The tannin yields a pale, light colored, soft leather. It is generally used in combination with other tannins. The manufactured liquid extract has approximately 45 percent tannin. The solution is mellow.

Oak bark is, perhaps, the oldest tanning material. It is mellow in solution, although it contains no more than 15 to 17 percent tannin. It produces a very bright leather. There is also an oak extract on the market.

Quebracho is derived from a tree (*Quebrachia lorentzii*) which is indigenous to South America and extensively cultivated in plantations. The bark or ground wood, which contains 18 percent tannin, is used; or else a solid extract of 63 percent tannin content is made from it. It gives an astringent solution.

Sumac is derived from dry leaves and small twigs of a shrub (*Rhus coriaria*) which grows in Sicily and in southern Italy. It is marketed as a dry powder, or else in the form of extracts. It gives a very light, pale biscuit-colored leather which is soft, full and plump. The solution is very mellow.

There are many other sumac tannins derived from trees or shrubs of the same family growing in the United States, Spain, South Africa and in other parts of the world. But they contain less tannin.

Tara is the name commonly given to a tanning material which consists of the dried pods of *Caesalpinia spinosa*, a tree or shrub widely distributed in northwestern South America and also grown in many parts of North Africa, especially Morocco.

Tannin content is variable and figures ranging from 35 to 55 percent have been given. The main value of tara pods is in the tanning of light colored leathers, for they impart but little color to the leather.

Valonia is made from the cup of an acorn found on certain species of oak (*Quercus aegilops*) which grow in Greece and in Turkey. It is sold as a liquid which is mellow or as a solid extract — and cups and beard are also commercially available — and it is used extensively to make sole, harness and other heavy leathers.

Vegetable tannins for rural tanners

The advanced tanner will use imported, concentrated and expensive tannins in the form of baled or pressed solid material or in the form of liquid and highly concentrated extracts in barrels. He can afford neither the time nor the space to use tannin-bearing materials which have only a low tannin content. The small rural tanner, however, will certainly want to use easily obtainable materials — particularly for the tanning of light leather — which cost little or nothing, even if the tannin yield is rather low.

It is impossible to enumerate all the tannin-bearing plants, even though many are known and rural tanners have been using them for centuries.

Bark is stripped from trees by a special peeling iron. The stripping is done in such a way that only a part of the bark is peeled off. It does not damage the tree permanently.

In certain parts of the world this is a special trade, and the product is sold to large tanneries. To avoid the deterioration of grassland and soil erosion, however, bark peeling should be controlled.

The gathering of tannin bearing pods, leaves and twigs is a source of income for the rural areas. Collection must be done carefully, and the material gathered must be of the right maturity — that is, when the tannin content is at its highest. The materials must be protected from the leaching effects of rain. They must be free from contamination, and particularly from contamination by soil; for it may contain iron salts which cause a discoloration of the finished leather.

Since the tannin-bearing material may not be available at all seasons, it should be collected and stored for later use. Storage must offer protection against rain, though the material must also be open to the air. To prevent mold growth and fermentation, the material should be turned over from time to time or, better still, laid out in the sun for a day.

Two or more tannin-bearing materials must not be mixed at any preliminary stage, even when they are finally to be used together for tanning.

To the rural tanner of tropical and subtropical Africa and Asia, the acacias are one of the most important tannin-bearing trees.

Several species, such as *Acacia arabica*, *A. nilotica*, and *A. adamsonia*, have supplied pods and bark since immemorial times. They probably explain the origins of vegetable tanning in Africa and Asia. The leather produced by acacia pods is soft, plump, light colored and durable, and it can be readily dyed. Their solutions are mellow. No wonder highly skilled artists appeared in those countries where the acacia is grown. The acacia pods and bark are known variously in the countries where they grow as *babul* (Hindustan), *babar* (Sind), *garad* or *sunt* (Sudan), *babla* (Arabia), *neb-neb* (West Africa) and *gabaru* (Nigeria).

The pods used for tanning are from 10 to 15 centimeters long and 1 centimeter broad, and they have 8 to 10 seeds. Contrary to common belief, the seeds do not contain tannin, which is present only in the pods. The pods should be collected when they are ripe: for their tannin-content reaches the highest level just as they are falling from the trees; it is inadvisable to wait to collect the pods from the ground, for they will then be contaminated with sand, clay, moulds and other undesirable matter. According to the conditions of the soil and the climate, their tannin-content varies from 20 to 30 percent. The material contains an undue proportion of nontans and a high proportion of sugary matter in the seeds. This results in a rapid fermentation of the liquor.

The bark of the *Acacia arabica* does not contain more than 14 percent tannin and is mostly used in northern India under the name of *babul bark*. The bark from old trees yields a very dark colored tannin. It is best, therefore, to strip from trees which are from five to seven years old. When *babul bark* is used for tanning, it gives a leather which has a darker color and a tendency to crack and tear; but when it is suitably blended with *myrobalan* (3:1) or with *avaram bark*, it can be used with advantage, particularly in sole leather tannage.

Avaram or *turwad bark* (*Cassia auriculata*) and *konnam bark* (*Cassia fistula*) have been used in southern India since time immemorial, and they were the foundation of the crust leather industry. The *avaram bark* contains from 15 to 17 percent tannin; the *konnam bark* contains only 10 to 12 percent. Both give a light colored leather: but, like all catechol containing tannins, it darkens when it is exposed to sunlight. The red color difficulty, however, can be solved if tanning is completed with *myrobalans*. *Avaram bark* is easily

soluble in water, but a big residue of less easily soluble tannin is often left unleached.

Avaram tanned leather is tough and almost untearable, while the final treatment with myrobalans and oiling increases weight and produces an extremely pale color.

Konnam bark, it is stated, gives a very smooth grained leather and a very pale color. Some tanners mix it with mimosa bark to produce a mellower tannage than is given by mimosa bark alone.

Pomegranate is the dried skin from the fruit of the pomegranate (*Punica granatum*). It gives a pleasant yellow, or red colored, leather. It is extensively used in North Africa and around the Mediterranean.

Besides the black wattle, which, as has been already mentioned, is used commercially for mimosa extracts and bark, at least three other types of wattle — *silver*, *green* and *golden wattle* — are available for the tanner.

The *Eucalyptus* group, so widely distributed over the world, is also a source of good tanning material. Mallet bark, which has been already mentioned, has a commercial importance. Another type of tannin extract called *myrtan* is derived from a plant of this family. A third type of eucalyptus is the red iron bark tree, and tanners can use not only the bark, but also the resinous exudate, which is called kino. This is an excellent, highly concentrated tannin. Many other eucalyptus trees produce similar tannin-rich exudates. *Ximenia*, *Avicennia* and *Bridelia* yield bark which contains 12 to 20 percent tannin.

Tara pods from *Caesalpina tinctora* contain tannin very suitable for sheepskins. They produce soft, nearly white leather. They are used extensively in North Africa.

Bauhinia, the camel foot tree, *Cassia*, the iron wood tree, and *Woodfordia* can all be used as sources of tannins.

Pine bark can be used extensively; it produces a light brown leather and contains sugars which assist fermentation.

The inner bark of a birch tree as well as larch bark can be used successfully.

Another tannin, called *Algarobilla*, comes from a similar plant grown in Central America and the West Indies. The pods have up to 50 percent tannin.

The galls of the tamarisk shrub contain up to 50 percent tannin. Guava, a common fruit-tree, has a bark which gives 30 percent tannin. Its leaves give 10 percent tannin.

Even some of the parasitic plants which grow on trees or shrubs — for example, *Hydnora* — yield tannin.

Tea leaves contain an appreciable amount of tannin. Owing to their high price, however, they cannot be used commercially.

The number of tannin-bearing trees and shrubs is enormous. None the less, the plants vary widely in tannin content; for this is affected by the prevailing climatic conditions, by the soil in which they grow, and by their age.

Once more it must be emphasized that when a tannery is started in a dry area, leaves, twigs or pods should be used rather than bark or roots. The damage done to the neighborhood by a rapid destruction of its trees can be far greater than the benefit derived from a new tannery.

Blends in vegetable tanning as used in India

The Central Leather Research Institute in Madras, India, has given particular attention to the use of blends for the vegetable tanning of hides and skins. Here follows a description of some useful blends.

SOME BLENDS FOR EAST INDIAN TANNING OF SKINS

Avaram bark is primarily used in the East Indian tanning of skins. Myrobalan nuts are used for topping the avaram tanned skins.

The avaram bark is partly or wholly substituted by konnam bark, babul bark and wattle bark. Other good substitutes are the newer tanning materials like vagai bark (*Cassia marginata*), eyal vagi bark (*Peltophorum ferrugineum*), vel velam bark (*Acacia leucophoea*), kodukkapuri bark or camachile (*Pithecolobium dulce*), hopea bark or iron wood (*Hopea parviflora*) and dhawa leaves (*Anogeissus latifolia*).

The following blends can be used for the East Indian tanning of skins:

Avaram 3	Konnam 2	Babul 4
Konnam 4	Dhawa 1	Wattle 1
Avaram 2	Avaram 4	Avaram 2
Konnam 3	Konnam 1	Babul 2
Wattle 1	Myrobalan 2	Wattle 1
Konnam 2		
Wattle 1		
Myrobalan 2		

SOME BLENDS FOR EAST INDIAN TANNING OF KIPS

The wattle bark is the main tanning material used in the age-old process of the East Indian tanning of kips.¹ The kips are also "myrobed" after wattle tanning. "Myrobing," incidentally, is the term used by tanners in southern India. It means a treatment with a tanning liquor which has been prepared from myrobalan nuts.

The wattle bark is substituted, partly or wholly, by avaram, konnam and babul bark, myrobalan nuts and wattle extract. Good substitutes are the newer tanning materials like karada bark, also called kodarsi (*Cleistanthus collinis*), goran bark (*Coriops roxburghiana* and other mangrove species), arjun bark, also called kahua (*Terminalia arjuna*), casurina bark, also called casagha pine (*C. equisetifolia*), kodukkapuri, vagai, eyal vagi, vel velam, hopea and dhawa.

The following blends can be used for the East Indian tanning of kips:

Karada 2-3	Karada 1	Karada 1
Myrobalan 1	Konnam 1	Babul 1

Karada, Goran, Arjun or Hopea 3 and Dhawa (Myrobalan) 1

Kodukkapuri 1	Kodukkapuri or Eyal Vagi 6
Konnam 2	Myrobalan 1

¹ See section on "General method of manufacturing East Indian tanned kips as widely practiced in India," in Chapter VI.

Vagai	2	Vagai	3	Dhawa	1
Konnam	1	Arjun	1	Konnam	2
Dhawa	1	Wattle	1		
Goran or Karada	1	Avaram	2		
		Babul	2		

SOME BLENDS FOR SOLE LEATHER TANNAGE

The wattle extract is the main tanning agent used in the East Indian sole leather tannage. It is substituted, partly or wholly, by quebracho extract, myrobalan extract, babul bark and divi-divi pods. Other good substitutes in the tanning of sole leather are karada, goran, eyal vagi, kodukkapuri, hopea and cutch extract.

The following blends can be used in sole leather tannage:

Wattle extract	3			Babul	3-6
Myrobalan extract	1			Myrobalan	1
Karada	3	Cutch extract	3	Eyal Vagi	4
Myrobalan	1	Myrobalan extract	1	Myrobalan	1
Hopea	6				
Myrobalan	1				

For the convenience of the tanner the blends are given on the weight of tanning materials which are to be blended.

One part of wattle bark on a tannin basis is approximately equal to wattle and myrobalan extract (0.5); myrobalan nuts, divi-divi pods and kodukkapuri (1.0); goran, karada, arjun and hopea bark (1.25); shawa leaves and eyal vagi bark (1.5); avaram, babul and velum bark (2.0) and konnam and casarina bark (3.0).

V. PREPARATION OF VEGETABLE TANNING LIQUORS

Grinding

Whether the tanning material is intended for use in its natural state, for dusting or for leaching, it must first be broken up by cutting or crushing. Large particles do not allow the tannin to be completely leached out, and it is advisable to use pieces which have been ground as small as possible. The rural tanner who uses small amounts can easily chop or grind the material to the required size.

If acacia pods are used, the seeds are undesirable because their high sugar content causes the tanning liquid to ferment too quickly. These seeds may be removed by riddling or by shaking the pods in a flat basket, thus separating them from the shattered pods.

Good results are obtained by using a wooden pestle and mortar for pounding the leaves, pods or fruit (Figure 29).

Small power-driven mills — in particular, for a group of co-operative organized tanneries — can also be used to advantage.

Leaching

In the tanning vats it is wasteful to use ground bark, leaves or pods, and it is difficult to control and to estimate the strength of the tanning liquor which is produced. Moreover, the rate of tanning with this material is very slow. It is advisable, therefore, to extract the tannins by a process which is called "leaching." This leached liquid or "tan liquor" can be used as and when it is required.

The aim of properly conducted leaching is:

- (a) to extract the maximum amount of tannins from the tannin-bearing materials; and
- (b) to prevent any injury to the infusion by contact with lime, iron or heat.



FIGURE 29. - Pestle and mortar used for pounding acacia pods in Nigeria, to make best use of these tanning materials.

Continuous production of tan liquor

The most economic and efficient way to make a continuous supply of tan liquor is to use a series of vats built in wood, brick or cement. Wooden casks or large earthenware pots are also useful.

The following rules should be followed:

1. At no stage must the tan liquor come into contact with iron or lime. Thus the vessels used to transfer the liquor, the ladles for stirring and the sieves for straining the liquor must all be made of one of the following materials: wood, earthenware, aluminium, copper, brass or basket work.
2. The water used for leaching must be rain water or soft and clean river water. If necessary, it must be filtered.
3. The bark must be completely covered with water during leaching to prevent oxidation for this causes dark tanning.
4. Although high temperatures assist leaching, boiling water should never be used.

PROCEDURE

Six receptacles are filled with pounded or crushed material. On the first day, water is poured into the first vessel to cover the crushed material completely (Figure 30).

On the second day, the tan liquor which has been produced in the first vessel (A) is poured into the second vessel (B). Fresh water — hot, if possible — is poured over the disintegrated material in the first vessel (A) for its second leaching.

On the third day, the tan liquor in the second vessel (B) is poured into the third vessel (C). The tan liquor in the first vessel (A) is poured into the second vessel (B) and fresh water is poured again into the first vessel (A).

This process is repeated on the fourth, fifth and sixth days. One more vessel is used each day until all the vessels are in use. By this time, the material in the first vessel (A) will have been leached six times.

This material should now be exhausted. The tan liquor in the sixth vessel will be at the strongest because it has passed through all the six vessels. This liquor is now ready, and it is taken to the storage tank (Figure 30).

From the seventh day onwards, a spare vat is necessary when transferring liquors.

Now the battery is in full operation and the principles involved are:

- (a) fresh material is used to strengthen the strongest liquor;
- (b) fresh water — hot, if possible — leaches the weakest and nearly exhausted material;
- (c) the strongest liquor goes to the storage tank; and
- (d) after having been leached six times, the crushed and spent material is rejected.

In this way the tanner has made each day a definite quantity of strong tan liquor for his storage tank. From this tank he can draw liquor when it is required. He uses it to strengthen other liquor in any of the series.

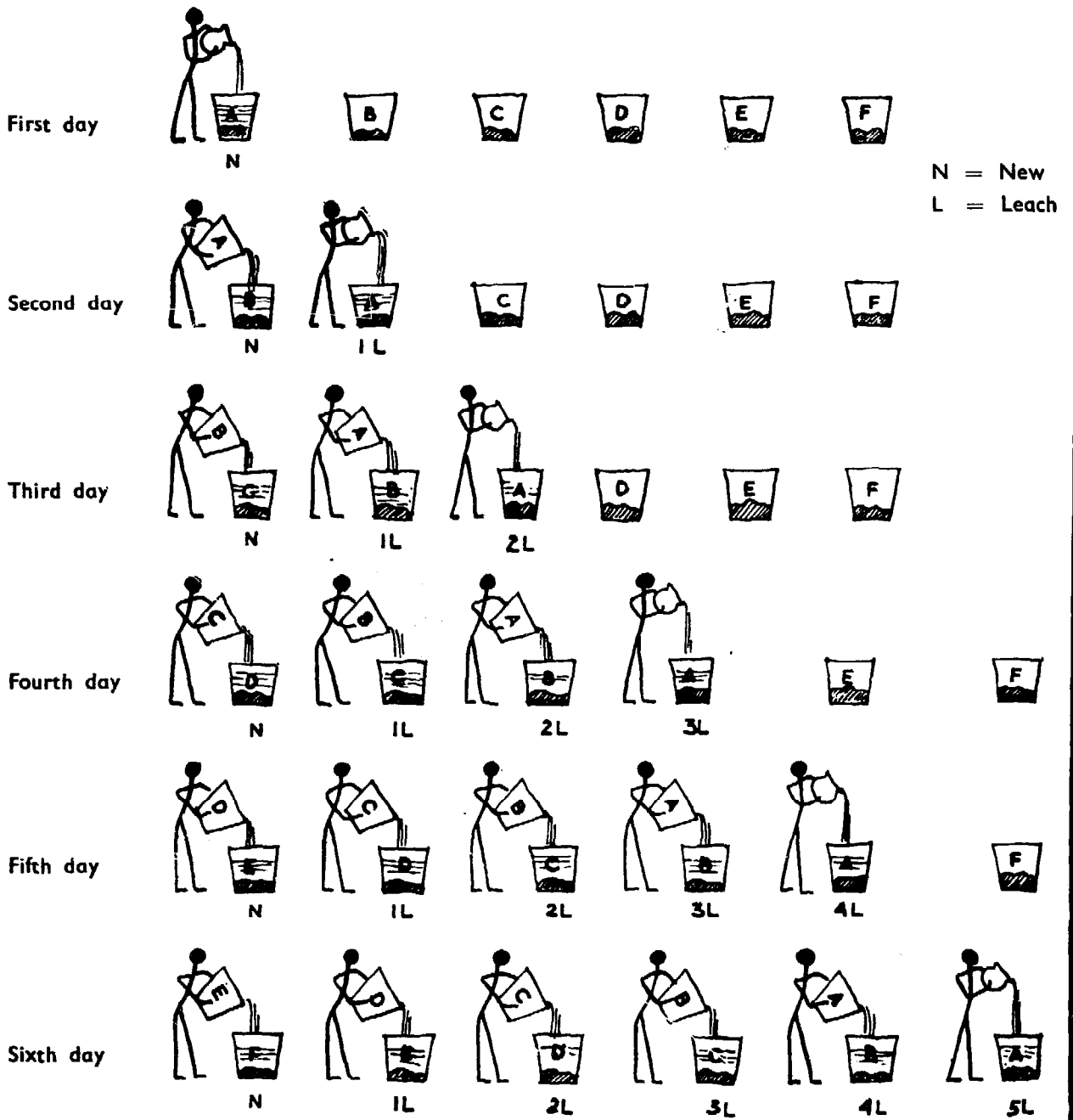

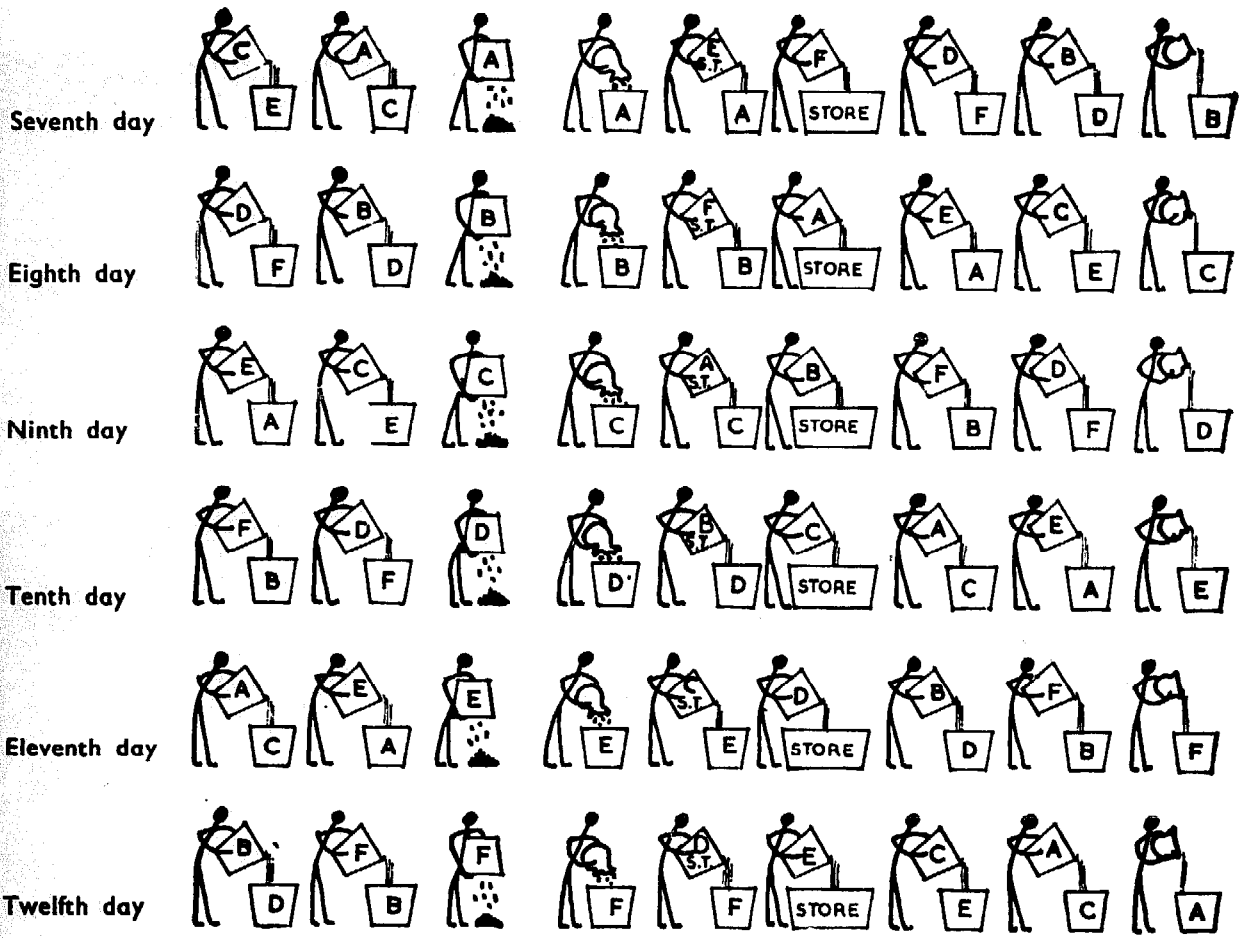

ST = Spare Tank

Thirteenth day like seventh, fourteenth day like eighth, and so on.

FIGURE 30. - Schematic flow chart for the continuous processing (leaching) of vegetable tanning materials, showing which particular operations are performed in the battery of vessels during the consecutive days the process continues.

Courtesy Mrs. Erica Mann

Commercial extracts manufacture

Large tanneries — anxious to save the time, installation, space and labor of leaching — prefer to buy concentrated extracts prepared in districts where the tannin-bearing plants grow. As a rule, wattle, cutch, mangrove, myrobalan, chestnut or quebracho extracts are used. They are marketed in two forms — as a thick liquid which contains about 40 percent tannin sold in barrels; or in a solid form which resembles toffee and contains up to 60 percent tannin. The use of tannin extracts saves transport and storage, and it allows the use of tan liquors at high concentrations.

The preparations of extracts in large factories is similar to the methods applied by the small rural tanner. The stages of production are grinding, leaching and concentrating.

GRINDING

The material is chopped into small pieces by passing through a power-driven disintegrator or hammer mill.

LEACHING

The ground material is put into leaching vats. By passing the liquid from one vat to another it becomes progressively stronger. In modern plants vacuum pans have replaced open vats. The highly concentrated extract is prepared at low temperature and out of contact with air.

CONCENTRATING

In the concentrators most of the moisture is evaporated. At this stage the liquor may be drawn off and sold as a liquid extract which contains 35 to 45 percent tannin; or concentration may continue in large vacuum concentrators until the extract is toffee-like. It solidifies after it has been poured into bags. This solid extract contains up to 65 percent tannin. The application of commercially

prepared extracts is very simple: the required amount of liquor is made up by dissolving the extract in hot water, by passing live steam through it, or by steaming through copper pipes.

Use of the barkometer

Good tanning requires the use of a number of liquors which have increasing strengths. Rough results can be obtained by using different proportions of tannin-bearing materials with varying quantities of water. This method is still used in many countries. It is, however, very inaccurate: for the same tannin-bearing material from different places will yield different amounts of tannin. Waters, too, vary in their leaching properties, which depend on their temperatures and hardness.

A more accurate and easier way of determining the strength — that is, the concentration — of tanning liquids is the use of a barkometer, which is a special type of hydrometer.

A hydrometer indicates the specific gravity of a liquid. It consists of a long glass graduated stem with two glass bulbs. The lower, smaller bulb (Figure 31) is filled with mercury or lead shot. The larger upper bulb serves as a float, for it allows the graduated stem to stand vertically above the surface of the liquid.

When a hydrometer floats in distilled water at 15.6° C., it sinks to the mark 1.000 at the top of the scale. Thus it indicates the specific gravity of water at that temperature. This mark is the definitive standard for determining the specific gravity of other liquids.

For the barkometer used in tanning processes one degree barkometer (1° Bkr.) is by definition equal to a specific gravity of 1.001. Hence, 10° Bkr. equals a specific gravity of 1.010.

Whenever a barkometer is not available, a simple lactometer — an instrument used to measure the specific gravity of milk — can be used. The scale of a lactometer is marked with the same units as a barkometer, but it does not read above 38° or 40° Bkr., and it is unsuitable for the strong tan liquors used for sole leather.

A number of tanners and several textbooks use the so-called Baumé meter instead of the barkometer. The fixed points on the Baumé scale are 0, 10 and 66° Bé. These three fixed points are

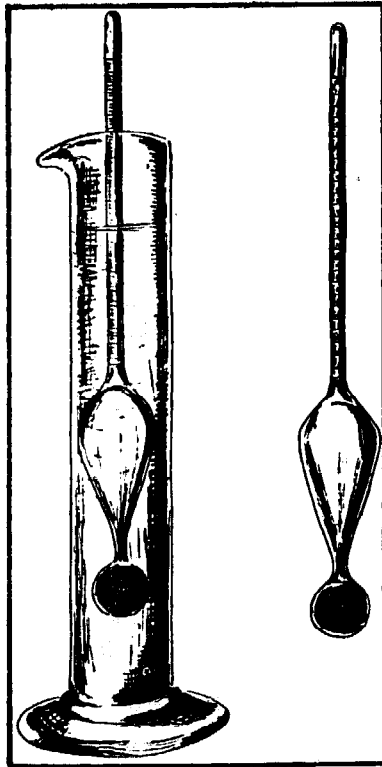

FIGURE 31. — *Sketch of barkometer and measuring glass.*

Courtesy Mrs. Erica Mann

found by floating the Baumé meter in distilled water (at 15.6° C.); in a 10 percent solution of sodium chloride; and in concentrated sulphuric acid (specific gravity 1.84).

Table 1 shows — through the use of any ordinary hydrometer — the conversion from specific gravity to barkometer reading and also to Baumé reading.

The use of the barkometer is very simple. Some of the tan liquor to be tested is put into a cylinder. The barkometer is then immersed and read off (Figure 31).

When the movement of both liquid and barkometer has stopped, the reading of the barkometer should be taken where the curved surface of the liquid touches the graduated stem. This reading varies with the temperature of the liquor. Some barkometers have a thermometer built into them. With others a separate thermometer can be used. The manufacturer of the barkometer encloses a table to compensate the readings for various temperatures when accurate laboratory conversions are required; but for normal tannery readings the use of the thermometer is not necessary.

TABLE 1. - CONVERSION FROM SPECIFIC GRAVITY TO BARKOMETER READING AND TO BAUMÉ READING

Specific gravity (s.g.)	Barkometer (Bkr.)	Baumé (Bé)
1.0007	0.7	0.1
1.0014	1.4	0.2
1.0020	2.0	0.3
1.0027	2.7	0.4
1.0034	3.4	0.5
1.0041	4.1	0.6
1.0048	4.8	0.7
1.0055	5.5	0.8
1.0062	6.2	0.9
1.0069	6.9	1.0
1.0076	7.6	1.1
1.0082	8.2	1.2
1.0089	8.9	1.3
1.0096	9.6	1.4
1.0103	10.3	1.5
1.0110	11.0	1.6
1.0117	11.7	1.7
1.0124	12.4	1.8
1.0131	13.1	1.9
1.0138	13.8	2.0
1.0173	17.3	2.5
1.0209	20.9	3.0
1.0244	24.4	3.5
1.0280	28.0	4.0
1.0316	31.6	4.5
1.0353	35.3	5.0
1.0389	38.9	5.5
1.0426	42.6	6.0
1.0463	46.3	6.5
1.0501	50.1	7.0
1.0539	53.9	7.5
1.0576	57.6	8.0
1.0653	65.3	9.0
1.0731	73.1	10.0
1.0850	85.0	12.0
1.1138	113.8	15.0
1.1578	157.8	20.0

One degree Bkr. is approximately equal to 0.3 percent solids. Thus 1 kilogram of dry extract dissolved in 300 liters of water gives a solution of 1° Bkr.

Other solid materials, however, will also dissolve, though they have no tanning property. They must be fully considered when reading the barkometer or the Baumé meter.

Basic principles of vegetable tanning

The principal of vegetable tanning is that when tannins come into contact with hide proteins, they combine and react together to form leather; and this completely new product is resistant to putrefaction.

Immersing hides directly into strong solutions of vegetable tannins causes the surface to tan so hard that the tannin cannot penetrate into the center. This can be compared to putting bread into a very hot oven, where it rapidly forms a crust, while the inside remains uncooked.

To be successful, therefore, vegetable tanning has to start with a weak liquor and gradually to progress to stronger liquors. This may be achieved in two ways:

- (a) by passing the skins or hides through a series of vessels, each containing a stronger solution than the previous one; or
- (b) by strengthening the liquor in the original container by adding more tannin to it.

It is essential first to use mellow tan liquors and to follow them by using astringent tannins.

By astringent is meant a liquor which causes the fibers to contract. Astringent tannins draw together the grain of the pelt and produce hard leather. Very astringent tannins may produce a leather which is untanned inside, because the pores were contracted too rapidly. This causes "case hardening," which is also called "dead tanning." Mimosa and mangrove are highly astringent tannins. Gambier, myrobalan and acacia pods, on the other hand, are mellow tannin, and they produce soft leather.

It should be noted that some modern methods of tannage appear to contradict these postulates, in that good sole or light leather is made by adjustment of the pH of the hides, which are then immediately immersed in strong liquors of 70° to 90° Bkr. with consequent rapid tannage but not casehardening of the surface, although such liquors would be ranked as very astringent. This is a special technique involving the use of strong extracts and it is best to consult the extract manufacturer before embarking on one of these seven-day sole leather tannages.

In the section on "Liming" in Chapter III it was explained that a "mellow" lime is one through which some hides have already passed, so that it has lost some of its sharpness. Tan liquors, which have lost their astringency because some hides have already been tanned in them, are similarly termed "mellow;" for they have a higher proportion of nontans than tans.

VI. TANNING OF HEAVY HIDES

Heavy hides are used for soles, harness and belting; and light hides and calf skins are used for shoe uppers.

In large tanneries completely independent treatment is given to each of these leathers. A tannery may, in fact, specialize in making one product only. Under rural conditions, where the market for a given type of leather is limited, it is better to adopt one simplified treatment for all types of hides. Thus there is a common initial treatment. Later, if sole leather is to be made, the bend will be cut from the side and treated further.

Sole leather

The tanning of heavy hides, especially for sole leather, is a lengthy process. It is sometimes controlled by the laboratory in a large tannery (Figure 32).

Generally speaking, three methods of sole leather tanning exist:

- (a) pit tanning;
- (b) combination (mixed) tanning;
- (c) rapid tanning.

Pit tanning represents the old classical method of sole leather tanning. In the initial stages the pelts are tanned in the normal way; but the process is finished with bark in layaway pits. Though it depends on the tanning material which is available, the process can take up to one and a half years. The finished product is a high quality sole leather. There are now, however, only a very few tanneries

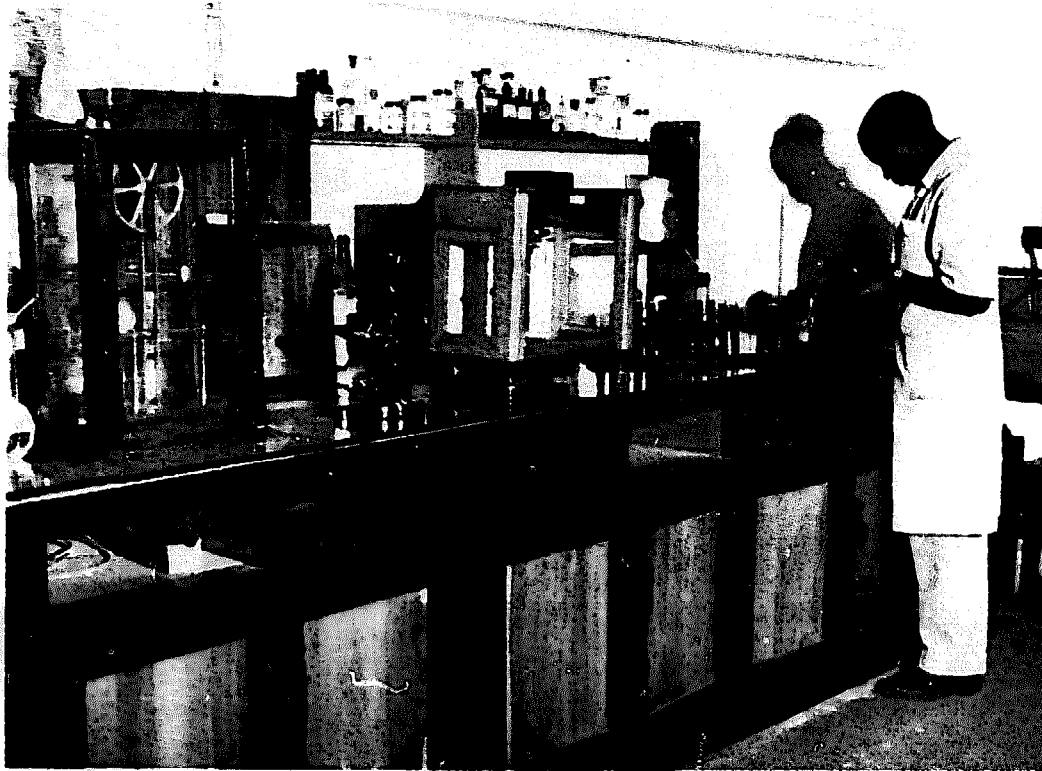

FIGURE 32. - *A testing and control laboratory as sometimes used in large tanneries.*

Courtesy Kenya Information Office, Nairobi

which still use this process. The reason is that the process requires very much labor and a high capital investment. Together they make the product rather expensive.

In the combination (mixed) tanning method, the pelts, in the initial stages, are tanned in the same way as in pit tanning, but the layaway pits are replaced by tanning drums (Figure 33). In some tanneries the finishing is done in hot pits instead of tanning drums.

In the rapid tanning method, after a short period of initial tanning, the process is finished in drums. This is very often followed by retanning (filling).

For a vegetable tanning, the drums should not make more than eight turns a minute, otherwise the hides and the tanning material could become too hot. At the beginning of the operation particularly, one has to be careful and it may be necessary to reduce the number of turns for hides which become hot.

The fundamental idea of pit tanning is universal, but it is natu-



FIGURE 33. - *Rural training center, Bakshi-ka-Talab, Uttar Pradesh, India. Drum tanning.*

rally adapted to tanning materials, climatic conditions and hide supplies in different countries. The consumer in a hot dry climate, it is obvious, demands an article different from the one demanded by a boot maker in the cold mountain districts in Asia or in Europe.

In the tanning of skins, the weight of the leather which is obtained has no importance for the tanner, for this leather is sold by the square foot or the piece, and not by the weight. Crust "East India" tanned skins, however, are sold by weight in London. Sole leather is also sold by weight. For this reason, the tanner aims at the fullest penetration and the maximum combination of all the tanning materials, so that the maximum weight and quality are obtained. Chrome sides and calf for uppers are often sold by piece or by the square foot.

The duration of the tanning process for hides is extremely variable. Many weeks, or even months, are required to achieve complete penetration and fixation of tannins through a thick, heavy hide. Very strong tan liquors are needed, and these, in turn, require skill in their preparation, unless tanning extracts are used. It is a mistake to attempt to make sole leather without proper investment and the necessary patience. Sole leather prepared by primitive tanners is often tanned superficially, while the center is still raw. Although this leather may look nice when it is dry, it starts to rot immediately it comes into contact with water.

When the initial tanning is too rapid, it is extremely dangerous. The outside becomes hard too quickly, it is termed "case hardening"



FIGURE 34. - *Suspender vats as used in large tannery.*

Courtesy Kenya Information Office, Nairobi

or "dead tanning" and this prevents the tannins from penetrating to the center, which remains untanned. Similarly, it is dangerous to use very astringent liquors too early for the sake of speeding up the tanning of sole leather; for this makes the grain drawn and wrinkled. Therefore, the tanning of sole leather must be a slow process. Attempts were made to hasten this process to save time and capital. This was achieved by the following method, which, until a few years ago, was still used in some English tanneries.

First, the butts are suspended for approximately 12 days in vats which contain tan liquors in progressively increasing strengths. These vats are called "suspenders," because the butts are suspended in the liquor on hoops of string fastened to wooden slats which rest on the walls of the vat (Figure 34).

The second operation takes place in other vats which are called "handlers." Here the butts remain for approximately six weeks. The name "handlers" comes from the frequent handling of the

goods. The butts are laid horizontally, grain side up, and they are taken out three times a week while the liquor is strengthened.

The third operation, which is called "dusting," consists in laying the butts in strong tan liquor, grain side up, one on top of the other, with a few handfuls of ground bark between them. This bark keeps the hides apart and replaces and replenishes the tannins taken up by the hides. When the "laying" and dusting are completed, the pack should be totally immersed. In these pits, which are called "layers," the hides remain for four to five weeks.

For the fourth stage — to obtain a good, hard, firm and heavy waterproof sole leather — the butts are transferred to the so-called "hot pits," where they are suspended in strong tan liquors of over 100° Bkr. at very carefully controlled temperatures (40° C.) and acidity.

The process can ruin the leather, unless the behavior of the particular extract is thoroughly known, and unless the conditions of hot pitting are accordingly adjusted.

The conversion of raw hide to finished sole leather is shown in the following timetable.

TABLE 2. — APPROXIMATE DURATION OF EACH PROCESS FOR THE MANUFACTURE OF SOLE LEATHER

Process	Time (weeks)
Soaking, liming, unhairing	2
Suspenders	2
Handlers	6
Layers	5
Hot pit	1
Drying, finishing, rolling	3
TOTAL	19 (or nearly five months)

Even today, despite the availability of highly concentrated extracts, the application of mechanical agitation, and a greater knowledge of the subject, the tanning of sole leather is a relatively slow process, and it takes not less than 12 weeks. In many countries, however, soft, pliable sole leather is required. Here the use of hot pits must be avoided, and the tanning is finished in layers.

Sole and other heavy leather

Without proper vats large enough to accommodate the hides, whether lying down or suspended, sole leather of good quality cannot be expected.

The vats required are:

Suspenders: 8, but preferably 10

Length: 1.5 to 2.1 meters
Width: 1 meter
Depth: 2 meters or more, according to the size of the hides.

Layers: 2 or 4

Dimensions: as suspenders, or slightly wider to take sides (see below)
Depth: 1 meter above ground level.

These pits could be built partly above ground level (about 1 meter), but the rest should be sunk into the ground. The vats may be built of brick, stone, concrete or wood, but no iron work or lime must be used; and it is unwise to sink large earthenware pots entirely into the ground (Figure 35).

Besides the making of sole leather, these vats can be used for uppers, harness and other leathers which in large tanneries have their separate vats. In large tanneries, as has been already explained, the bellies and shoulders are cut from the hides after liming and selected for sole leather. The butts are then tanned separately. The rural tanner, however, has little space available. He should adopt a method in which the sides for upper leather, harness or upholstery, and those for sole leather, are initially tanned together.

He can do this by cutting all hides, before they are suspended in the vats, into two halves and by tanning them as sides; the sole leather is tanned as bends and not as butts.

When the shoulders and bellies are tanned through, they are cut off and removed from the tan liquor. The remaining bends are transferred to the layers for a further tanning.



FIGURE 35. - Vats made by sinking large earthenware pots into the ground. This practice is not recommended.

Courtesy Kenya Information Office, Nairobi

The whole process is as follows: Sides are hung from sticks or slats by means of short strings, and they are completely immersed into tan liquor in the suspender. The first vat of tan liquor should have a strength of 5° Bkr., the next a strength of 9° Bkr. and so on until the last one, which has a strength of 33° Bkr.

The sides are left for two days in each vat. This makes a total period of 16 days. If they are very thick they should remain in each suspender for three days instead of two. The total period is then 24 days.

By this time the thinner sides for uppers, harness, saddle and upholstery leather should be ready. This can be tested by cutting through the thickest part of the hide to ensure that the actual center has been tanned completely and that no light-colored streak of raw hide remains.

When the shoulders are very thick, and when the hides are intended for harness or upper leather, they may need refreshing and shaving. They should be removed from the suspenders and refreshed on the third and sixth days, until the leather is of even thickness. Refreshing during the tanning operation, however, is not a practice to be recommended; it should have been done in the earlier stage.

The hides are taken out and moved up the series every other day. They are stretched and placed on boards over the vats to drain; and the first — that is, the oldest — vat is left empty and ready to receive fresh goods. While the hides are draining, the liquor is strengthened by rejecting some of the liquor from the first — the oldest — vat and by adding the stronger liquor from the second vat, and so on. Fresh, strong liquor, obtained from leaching, is added only to the last (eighth) vat. The bellies and shoulders in sides from which bends are to be cut for sole leather should also be ready. They should then be cut off, so that the bends are at hand for further treatment.

Whenever hard leather other than sole leather is required — for example, for harness making — the whole side may be treated in the layer vats, but only for one to three weeks.

The bends or sides are now transferred to layer vat No. 1, where they are laid flat, grain side up. A thin layer of ground tannin-bearing material is evenly spread over each — the operation is called “dusting” — and the next placed on top. This operation is repeated until all the sides of the same age have been placed in the layer vat. A piece of timber — or, better still, a piece of string — is placed on top of them to indicate where the batch ends, and a new pile is formed on top of the old one from the next batch. Strong tannin liquor — as strong, in fact, as it is possible to obtain by proper leaching — is poured into the vats until it covers the goods. It is advisable, however, to layer and to dust down in the liquor rather than adding liquor to dusted goods. In this way it is possible to avoid the air pockets which are otherwise difficult to press out from the bulk of the pack.

Twice weekly the sides are taken out of Vat No. 1 and piled into Vat No. 2, so that those which were on top in Vat No. 1 will now be at the bottom.

Once a week, when layering is completed, fresh ground tanning material is dusted over each layer, and the whole of the old material is removed. As the old material will not have been completely leached, it should be mixed with fresh bark and used again in the leaching vats.

According to the tanning material, the strength of the liquid and the thickness of the hide, the sole leather will be sufficiently tanned within three to six months.

General method of manufacturing East Indian tanned kips as widely practiced in India

This age-old East Indian tanning process, by which the largest amount of vegetable tanned leather in India is produced for export, makes use of wet salted cowhides.

These are first soaked in plain water for one to one and a half hours. They are then washed in four or five changes of water, drained well and weighed. After this, they are submitted to the liming process.

To straight lime liquor which has been used once — that is, liquor from which one batch of hides has been taken for fleshing — there is added 25 to 30 percent of slaked lime, based on the weight of the soaked hides. This amount can be added in one lot or in two equal installments during the first liming period — that is, before unhairing the hides. The hides are put in, one after another, hair side up — except for the topmost one, which is put in flesh side up — and they are left in the lime liquor for one hour. They are then hauled; the lime liquor is stirred and the hides are returned to it and left overnight. They are kept in this liquor for eight to ten days. During this period they are hauled every day and the lime liquor is stirred up. On the last day, the hides are unhaired.

They are now relimed in a fresh bath, to which is added 12 to 15 percent of slaked lime, based on the weight of the soaked hides. They remain in this new lime liquor for four days. During this period they are hauled; the liquor is stirred up and the hides are put back every day. This time, however, all hides — with the exception of the bottom one — are laid flesh side up. On the evening of the fourth day, they are taken out of the lime liquor and left overnight in plain water. They are fleshed by hand over a beam on the next day and then weighed. After this, they are washed and trampled in several changes of water, scudded and left in water overnight.

On the following day, they are again washed and trampled and lightly fleshed a second time. After this operation, about 57 grams of sulphuric acid (specific gravity 1.84) per hundred, based on the fleshed pelt weight, are added to the water. The hides are trampled in this for about ten minutes, scudded, washed two or three times, scudded again, washed twice more and scudded once more. They are piled to drain and then trampled for about 15 minutes in a bath

containing 85 to 113 grams per hundred of sulphuric acid and 4 to 5 percent common salt, based on the weight of the pelt (pickling). The hides may now be washed, and they are ready for tanning.

Old bark liquor, to which fresh bark or mixtures of bark and extracts are added, is always used at first. The old bark is removed from the vat; the clear liquor is decanted into another vat, and a very small quantity of bark and extract mixture is added and left overnight. On the following day, the required quantity of bark or bark and extract, containing 8 percent tannin, is soaked in this liquor. This 8 percent is calculated on the fleshed weight of the hides and represents about half the total amount of tannin required for the complete process. The total amount required is 17 percent.

For instance, if a mixture of wattle bark, mimosa extract, konnam or babul — instead of konnam — bark is used, the total amount of tan stuffs required for the first and second tanning should have at least 17 percent tannin, based on the fleshed pelt weight. To yield 17 percent tannin, it must be remembered that wattle bark contains 6 percent tannin; mimosa extract contains 3 percent tannin; and konnam or babul bark contains 8 percent tannin.

When uncrushed konnam or wattle bark is used, it is advisable to cut this into small pieces; big pieces should be soaked in water for a short time first. In any event, barks should be passed through two or three changes of water to remove any adhering dirt. They should then be soaked in liquor, as has been already mentioned, and stirred several times.

The delimed hides are dipped in this liquor one by one; they are moved to and fro for a few minutes, and then they are immersed and pressed down to the bottom of the pit. After five minutes, they are hauled and returned to the liquor. This operation is repeated after 10 or 15 minutes, while the bark is kept at the bottom of the pit and the remaining half is kept at the top of the tan liquor. On the following day, the hides are hauled once in the morning and once in the afternoon and returned to the same liquor. If the hides, when hauled in the afternoon appear to be pulled down too much, they are laid grain sides together into the liquor and bark is sprinkled on the flesh sides.

On the third or fourth day, they are beamed on the flesh side. They are then returned to the same liquor, hauled after ten minutes and returned once more to the liquor with bark sprinkled on the

flesh side. They are kept in this liquor for four days. During this period they are hauled once every day in the manner which has been already described. On the last day, the hides are taken to the second bark liquor.

For this liquor, bark or bark and extract mixtures containing 8 percent of tannin, based on the fleshed pelt weight, is used. The tanning material should be soaked in old liquor for a day or two before it is used.

The hides which have been removed from the first bark liquor are beamed, wrung out and placed, one by one, into the second bark liquor. They are hauled after five or ten minutes and returned, one by one, to the pit, and bark is sprinkled between them.

They stay in this liquor for five days. During this period, they are hauled and returned to the pit once daily, while bark is sprinkled in between them. If, at this stage, the hides appear to be flaccid, they are beamed and returned to the liquor, to which a little bark or extract, or both, is added.

The goods are left in this liquor for another seven or eight days and again they are hauled and put back every day. On the last day, they are kept in a pile in the same liquor; and half the bark is kept at the bottom of the pit or vat, and half is kept on the top. The pile should not be disturbed for 24 hours.

For myrobing, the goods are soaked overnight in hot water, to which is added the required amount of crushed myrobalan of good quality. The amount is calculated to be from 187 to 248 grams for every kilogram of expected leather; and this is, on an average, 45 percent of the fleshed weight of the pelt. On the next morning, this liquor is diluted to the required strength, with cold water.

The hides are rinsed with plain water, wrung out, dipped, one by one, into the myrobalan liquor and placed into another tub nearby. When all the hides are thus dipped, they are left in a pile for five to ten minutes. After this, they are hauled and put back in a pile in either the same or another tub, and the myrobalan liquor is poured over them. On the next morning, the hides are hauled and returned to the same liquor.

On the same day, an amount of crushed myrobalan, equal to the first, is soaked in hot water in a separate tub and left overnight.

The hides are beamed, wrung out and put into this second myrobalan liquor. On the following day, the color of the hides is examined: if they have too much myrobalan color, they should be rinsed with water or with the same myrobalan liquor diluted with water. They are then beamed and oiled.¹ Heavy hides are wrung out first.

The hides are oiled on the grain side — as a rule, with pungam oil — and they are piled one on the other. A thick, syrupy paste is prepared from one part Epsom salts (magnesium sulphate), one part glucose and two parts corn flour. This is applied on the flesh side, and then each hide is hung to dry. When semidry, the hides are piled again and left overnight. Next day they are set out on the flesh side, on a wooden plank or table, with a stainless steel or brass slicker.

If a light-colored flesh side is required, a thin corn flour paste should be applied to it. If more weight is wanted, a thick paste is prepared from one part Epsom salts (magnesium sulphate), one part glucose, two parts corn flour and sufficient water, and it is applied to the flesh side. These pasted hides are set on the grain and hung up until they are semidry. They are then lightly slicked on the grain, folded along the back bone with the grain side in and dried completely. The dry hides are again lightly slicked on the grain to produce a gloss. They are then trimmed and sorted into grades.²

Vegetable tanned sole leather by rapid pit tanning process

In this process, as developed by the Central Leather Research Institute in Madras, wet salted local buffalo hides, which weigh from 18 to 23 kilograms each, are soaked in plain cold water for a period of 6 hours after the excess salt has been removed. The hides are then cut into sides which are washed in 4 changes of water. They are trampled during each change.

They are limed in once-used second lime liquor with the addition of 6 percent of slaked shell lime powder. Handle the sides twice. Next day haul them up and add to the same bath 1 percent sodium sulphide (60 percent fused), which has been previously

¹ See Chapter IX.

² See Chapters IX and X.

dissolved in hot water. Put the sides in this sharpened lime liquor and haul them the same evening. Afterwards return them to the same liquor. Next day the sides are unhaired and relimed.

In the second liming operation, the sides are put for a further period of two days into a fresh bath, to which has been added 12 percent slaked lime powder and one percent caustic soda.

On the first day the sides are hauled twice. Next day they are hauled only once. They are fleshed, weighed and washed; and then they are left overnight in plain water.

Up to fleshing, the percentages are all based on the wet salted weight.

Next day trample the sides for a period of 15 minutes. Then scud and leave them overnight in plain water. On the following day, the sides are again trampled for a period of 15 minutes. Then they are scudded, washed and delimed with 1.5 to 2 percent of sodium bisulphite, which has been dissolved separately in cold water. This should be added to the bath over a period of 15 minutes if it is done in drums, or 30 minutes if it is done in pits. Drum the sides, or trample them, until the cut section of the butt when tested with a 1 percent alcoholic solution of phenol phthalein shows that one quarter of the total thickness is delimed. When this is so, add to the same bath a diluted solution of formic acid and use 0.75 to 1 percent, or 170 to 227 grams per hundred of sulphuric acid (specific gravity 1.84). Drum the sides, or trample them, until the cut section of the butt shows that one third of the total thickness is delimed. Then the sides are lightly scudded, rinsed with plain water and taken to suspenders.

The vegetable tanning process is as follows: the sides are suspended and tilted several times in an old liquor of 10° Bkr. strength and a pH of about 5 to 5.5.

The procedure is repeated on the following day. When it is completed, the sides are beamed on the flesh side. They are then laid flat in a tan liquor of 20° Bkr. strength; and only mimosa extract is used. They are handled once in the evening, and then as follows:

third day - piled and transferred to 30° Bkr. liquor

fourth day - beamed and put back in the same liquor

fifth day - piled and transferred to 40° Bkr. liquor

sixth day - beamed and put back in the same liquor
seventh day - piled and transferred to 70° Bkr. liquor
eighth day - beamed and put back in the same liquor
ninth day - piled and transferred to 100° Bkr. liquor
tenth day - beamed and put back in the same liquor

On the eleventh day the sides are piled, drained well and dipped in a myrobalan liquor of 60° Bkr. strength. This liquor is prepared a day beforehand by soaking in hot water and by using 25 percent of the powdered myrobalan nuts. On the twelfth day, the sides are hauled and put back in the same liquor. Leave the goods in the same bath for one day more. Now the sides are washed on both sides with plain water and piled for two days, while kept grain to grain and well covered.

In the oiling operation which follows, the sides are first drummed for 15 minutes in a slowly revolving drum with the addition of gum tragacanth paste, using 57 to 85 grams per hundred of the gum. Then add 2 percent of Epsom salts (magnesium sulphate) and drum again for 15 minutes. Then add one percent glucose. Drum for 15 minutes. Then add a mixture of 3 to 4 percent of raw pungam oil and 1.75 percent sulphonated pungam or castor oil. Drum the sides for half an hour. Stop the drum for half an hour, and again drum the sides for another half an hour. Then the sides are removed from the drum and hung to dry. When sammed, the sides are set well and again hung to dry. Again set twice before the drying is complete.

The percentages — from delimiting to oiling — are all based on the fleshed pelt weight.

Finally, the dried sides are seasoned and rolled in the usual manner, which involves the use of casein solution, soap, linseed mucilage and gelatine. They are then rolled on and rolled off. The yield obtained is 53 percent, based on the fleshed weight.³

For another process of rapid tannage of sole leather, which has also been developed by the Central Leather Research Institute in Madras, wet salted buffalo hides with an average weight of 20 kilo-

³ See Chapters IX and X.

grams are suitable. They can be green, wet salted, dry salted, or dry cured. Their weights correspond to the wet salted weight which has been already mentioned. Green and wet salted hides are thoroughly washed in two or three changes of plain water, cut into sides and then put into the liming process. For dry salted and dry hides, the soaking period may vary between 24 to 72 hours, according to the condition of the hides and the efficiency of the soaking agents which are used. The best proportion of soaking agents are 100 grams of caustic soda or 200 grams of sodium sulphide (60 percent fused) for 100 liters of water. It is advisable to add 50 grams of bleaching powder.

Liming is done first in once used liquor, to which are added 10 percent slaked lime and 0.5 percent of sodium sulphide, based on the soaked weight of the hides. The goods are handled and replaced three times a day for four days.

On the fifth day, the sides are unhaired and put into a new lime liquor. This is made up of 10 percent slaked lime and one percent caustic soda and about 400 percent of water, based on the soaked hide weight. The sides are kept in the liquor for four days, and meanwhile they are handled and replaced three times a day.

On the ninth day they are fleshed, washed well and weighed to determine the limed pelt weight. The new lime liquor now used is the once-used lime liquor for the next pack of hides.

The sides are delimed in a pit in which 0.5 percent boric acid, based on the pelt weight, is used. They are kept overnight in the deliming bath. Next morning they are handled again. A fresh amount of 0.5 percent boric acid is added to the bath until one quarter of the thickness of the pelt both from the grain and the flesh side is delimed, as tested by a one percent alcoholic solution of phenol phthalein. At this stage, the sides are ready for tanning.

They are put into the first suspender liquor, which is a mellow one of 7° Bkr. and made from wattle bark or mimosa extract. They are handled in this liquor for the day and kept overnight. Next day they are transferred to the next pit. This contains the second suspender liquor, of which the strength is increased by 2° Bkr. In this way the sides are passed successively every day through 7 suspender liquors. The strength of the liquor of each succeeding pit is higher by 2° Bkr. than the previous one, and the last suspender liquor is of 19° Bkr. There the preliminary treatment in suspenders is completed. From the last suspender, the goods are taken out and

made ready for subsequent operations. Thus the total time of tanning in suspenders is seven days.

The material is tanned in 30° Bkr. liquor in a drum for eight hours. The drumming is intermittent, and the material is left stationary overnight in the drum. The liquor is strengthened to 40° Bkr. on the second day and again drummed intermittently for eight hours. Overnight the material is left stationary in the drum. Thereafter drumming is continued, and the strength of the liquor is increased by 20° Bkr. after every two days. Drumming is intermittent for eight hours each day; and each day the strength is adjusted until the material has been tanned in 80° Bkr. for two days. Total drum tanning from 30° to 80° Bkr. takes six days. The speed of the drum is 4 revolutions each minute. The strong liquor is made from mimosa extract, which was dissolved in a suitable quantity of hot water in a pit. At the end of this period, the tanning is complete. The goods are taken out and horsed up for a day. Further operations follow, and they are now described.

The tanned sides are bleached with a solution of a bleaching syntan, 0.5 percent oxalic acid and 10 percent water, based on the weight of the leather. The duration of bleaching is one hour. The bleached goods are rinsed and treated with a myrobalan liquor.

The sides are handled in myrobalan liquor of 30° Bkr. for two days. The goods are kept for a further period of one day in the liquor, grain to grain and without handling. On the fourth day the sides are taken out, scoured, washed well and then piled up to drain. The goods are next oiled on the grain with pungam oil (3 percent, based on the weight of the goods) and the flesh sides are coated once with a paste made up of 2 parts of flour, 2 parts of Epsom salts (magnesium sulphate), 2 parts of glucose, 1 part of china clay and 4.5 liters of water. They are hung up to be sammed.

The sammed sides are set out twice, either by hand or machine, and dried.

The dry sides are finished on the grain side with a mixture which is 3 parts of casein, 0.75 part of borax, 6 parts of soap, 3 parts of linseed mucilage and 80 parts of water.⁴

The casein is dissolved in hot water with borax, and the linseed mucilage is extracted with boiling water alone. The solution of

⁴ See Chapters IX and X.

soap is made with hot water. The three solutions are mixed together. They are applied on the grain side of the leather with a brush and dried.

The sides are now rolled twice — first with light pressure, and then with a heavy pressure.

The leather is now ready for the market. The total period of tanning — from raw to finish — is 26 days. The yield of leather is 55 percent, based on the limed pelt weight.

Rapid East Indian tanning of cowhides

The reader is referred to the section on "Rapid East Indian tanning of sheepskins and goatskins" in Chapter VIII.

The method described in this chapter — notably the pretanning and tanning procedures — can also be applied to wet salted cowhides. There are, however, the following differences.

The soaked hides are put in a lime liquor which contains $\frac{1}{2}$ old liquor, $\frac{1}{2}$ water, 10 percent lime and 1 percent sodium sulphide, based on the soaked weight.

The hides remain in this liquor for three days with daily handling. On the fourth day, they are unhaired and put in a new lime liquor which contains 10 percent lime and 85 grams per hundred caustic soda, calculated on the soaked weight. They are handled for three days. On the seventh day, they are fleshed, scudded and put in plain water overnight. Next day they are again fleshed and scudded and delimed fully with 0.5 percent boric acid, based on fleshed weight. When fully delimed they are scudded, washed with water, trampled twice and pretreated.

One of the two pretreatments which are later described for skins can be used for hides.

The pretreated hides remain in the first bark liquor for five days and in the second bark liquor, according to the thickness of the hides, for five to six days. Tanning materials such as konnam, babul, wattle bark and wattle extract are used. They are blended in suitable proportions, and they contain 16 percent tannin, based on the fleshed weight. They are divided equally between the first and the second bark liquor.

For myrobing, 360 to 500 grams of good quality myrobalans per

kilogram of expected yield are used, and the tanned hides remain in this liquor for two days. Then they are wrung out and beamed. The expected yield is generally 45 percent, based on the fleshed weight.

A solution of Epsom salts (magnesium sulphate) is sprinkled on the flesh side and well rubbed, and the hides are piled for oiling. About 2 percent Epsom salts on the expected yield can be used. The hides are then oiled with pungam oil and hooked. When sammed, they are set well on the grain and folded along the back bone, while the grain side is kept inwards. Again they are dried completely. The dried hides are lightly slicked on the grain to produce a gloss. They are then trimmed and sorted into grades.⁵

⁵ See Chapters IX and X.

VII. IMPROVED RURAL TANNING IN INDIA

Rural tanning has been practiced in India since time immemorial by villagers who belong to the leather-working caste of *Chamars*. For generations, their tanning techniques have been handed from father to son.

It is estimated that village tanners, who are spread out over this vast subcontinent, process annually 8 to 9 million hides and 3 to 4 million skins. They handle both buffalo and cattle hides. The processes which they have developed over the ages are quite different from those used in the large leather factories of India. Large quantities of leather for the manufacture of village footwear and leather goods, for instance, are still turned out today by the so-called "bag-tanning" technique. As a rule, unfortunately, this leather is of poor quality; for it is spongy and overstretched, and it has a low resistance to water.

In the northern state of Uttar Pradesh, special efforts have been made to organize the rural tanners into co-operatives, and many village tanneries have been organized in this way. They are located at suitable distances from the villages and they are a far cry from the old, primitive cottage tannery-cum-living quarters. They are built of permanent materials, such as bricks, and equipped with pits, drums, bark crushers and leaching pits. They have adequate supplies of water, good drainage, oil powered engines and facilities for proper drying and storage.

Operations, such as soaking, liming, deliming, tanning and retanning, are carried out communally under the supervision of trained personnel. The village tanner is able not only to produce quality leather, but also to build up some working capital for still further improvement.

The Central Leather Research Institute in Madras has developed and introduced new techniques to improve the quality of bag-tanned

leather, and it has made this leather more wear-and-water resistant by the incorporation of resins and syntans -- that is, any synthetic high molecular compound which is able to tan.

Soaking

Well-soaked hides should contain about 60 percent water by weight. The soaking back of air-dried hides is accelerated by the addition of 1 to 2 kilograms of caustic soda to each 1,000 liters of water.

During the first day of soaking only half this amount is added. The other half is added on the following day to ensure a gradual soaking back of the dried hides. The soak pits should be large enough to take the dry hides in their "full spread;" for, at this stage, folding can cause permanent damage to the goods.

When the hides are considered sufficiently soft to withstand mechanical action, they are worked in a drum for about half an hour. Drumming, it is necessary to point out, must not be carried out for longer periods: for the frictional heat developed during the operation may permanently damage the hides. Drumming in running water is safe as well as effective, but the operational costs may be high. Where water is scarce, it is let in through the hollow axle of the drum and let out through a lattice door, which replaces the normal water-tight door.

As a rule, drumming is followed by what is known as "breaking over the beam." In this operation, the hides are thrown over scudding or fleshing beams, flesh side up, and they are worked all over with firm, but smooth, strokes with the blunt edge of a scudding knife. This helps greatly in softening the hides which are then returned to the soak pits and kept there until they are judged to be soft enough and ready for liming.

They are then removed, piled on the rims of the pits to drain for one hour, and weighed; and their weight is recorded.

Liming

Hydrated lime is becoming more frequently used in the small rural tanneries. It is easier to handle, and when it is packed in smaller quantities in paper bags, it does not deteriorate so quickly.

About 6 percent of hydrated lime, calculated on the weight of the soaked hides, is used. Sometimes, strong alkalis like caustic soda or sodium sulphide are added to the lime liquor; but these should be used carefully, for they cause excessive swelling (plumping) and loss of valuable hide substance. A quantity not exceeding 2 percent, based on the soaked hides weight, improves the liming effect.

In more progressive rural tanneries, however, increasing use is made of a lime — sodium sulphide paste. This involves using 6 kilograms of hydrated lime and 0.6 kilogram of sodium sulphide (60 percent, fused) per 10 liters of water. This paste is generally used for liming light hides and skins, when their hair or wool has to be saved. It is painted on the flesh side, and its concentration permits a maximum of 24 hours of piling. After this time, the hair should be loosened. There should be no excess paste liquor, but ample draining facilities should be available.

Tanneries possessing paddles (Figure 36) lime by keeping the liquor to goods ratio as 4 to 1. Where drums (Figure 33) are used, the ratio may be 2 or 3 to 1. The amount of sodium sulphide (60 percent fused) lies between 2 and 4 percent, while the quantity of lime is about 2 to 6 percent, both based on the weight of drained soaked hides.

If hair is of no value and drums are available, a pack of hides may be drum-limed in a float of 200 percent water, 2 percent hydrated lime, 4 percent sodium sulphide (60 percent fused) and 10 percent common salt, calculated on the "green" or soaked weight of hides. Drumming should be intermittent — that is, one or two minutes every hour — for 24 hours at a speed of 1 to 2 revolutions each minute.

Pit liming in fresh lime liquor for one or two days may follow, but liming should be cut down to the minimum for all upper leathers.

In paddle liming, 5 percent hydrated lime, 3 percent sodium sulphide (60 percent fused) and 20 percent common salt can be used to 400 percent water.

Paddling is done intermittently for 24 hours. Pit liming for one or two days may follow, if this is considered desirable.

Soft and supple leather is obtained by a liming process in which lime is predominant; for sole leather, pasting with sodium sulphide-lime paste followed by unhairing and an additional pit liming is also to be recommended. Painted hides may be washed before pit liming to prevent the sodium sulphide from being moved forward into the lime.

FIGURE 36. - Paddle used for liming, delimiting, and eventually pretanning operations.

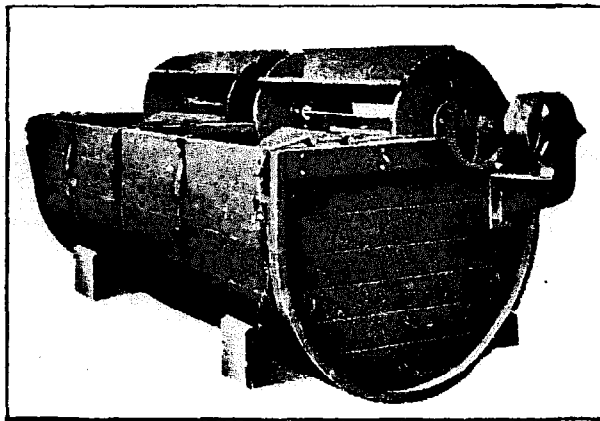

Unhairing and delimiting

Most of the hair remains on the hide during the liming process; and unless drumming or other mechanical means are employed to lime and unhair at the same time, human action will be needed. The hide can be placed over a flat stone on the ground or, preferably, over a beam and (Figure 23) worked over with a blunt knife or a proper unhairing knife. Indian rural tanners use a sharp, half-moon shaped knife, which they call a *rumpi* (Figures 37 and 38).

To reduce the plumping effect and to make the pelts more flaccid, the hides are kept in cold water which is softened with a little lime for some time, before cleaning the grain or scudding begins. This also prevents their exposure to the atmosphere, which can cause lime blast.

Scudding is generally carried out before delimiting and also, when it is considered necessary, after delimiting or bating.

To prevent any formation of lime blast on the hides before delimiting, it is a good practice to add some lime liquor to every water vat, if the water is "naturally hard."

Complete delimiting is not essential for producing sole leathers by the bag-tanning process, although washing is necessary to remove any loosely adhering lime. The usual period of washing in running water is 30 minutes. After that time, there will still be about 70 percent of the total quantity of lime, calculated on the dry weight of the pelt, left in the hide. To remove this lime, drenching is applied; and the pelts are immersed and left to soak overnight in water at 35° C., which contains bran. They are taken out on the following



FIGURE 37. - *Village tanners in India fleshing hides with half-moon-shaped rumpi (see also Figure 38).*

morning if — through the formation of gases in the fermentation process — they are found to be floating on the surface of the liquor.

Another method of deliming is to move or paddle the pelts in water which contains an organic acid, until they are completely delimed and show a neutral cut.

This is more rapid: for one hour's treatment with 1 percent acid based on the limed weight of the pelt may be sufficient. This process can be controlled more effectively, but many rural tanners prefer the former method: for they claim that it produces a fuller and cleaner piece of leather. Moreover, deliming with fermented infusions is cheaper.

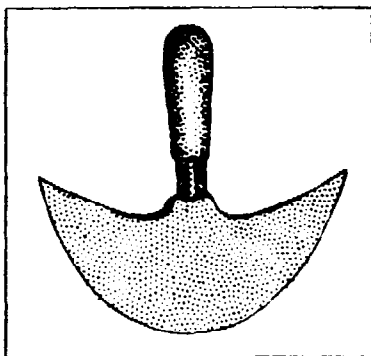

FIGURE 38. - *The rumpi, a half-moon-shaped knife widely used in Indian rural tanneries for fleshing operations.*

Bag tanning

An earlier description of the production of sole leather showed that the process is costly in space, equipment and time: to obtain a good product, great skill and patience are needed.

Bag tanning can be used with advantage wherever equipment and funds are in short supply. In this system, the hide is not tanned in a vessel, but is sewn up in the form of a bag, which is filled with bark and tanning liquor and suspended from a beam (Figures 39 and 40). By this ingenious method of using the hide itself as a tanning receptacle, leaching and tanning can be combined in one operation.

In bag tanning only vegetable tanning materials which are easily available in India are used. The most common are listed in Table 3.

TABLE 3. - RAW VEGETABLE TANNING MATERIALS AS COMMONLY FOUND IN INDIA, AND THEIR TANNIN CONTENT

Material	Approximate tannin content (percentage)
A varam, or tarwar (<i>Cassia auriculata</i>)	14-18
Aonla bark (<i>Embllica officinalia</i>)	12-20
Babul bark (<i>Acacia arabica</i>)	11-18
Dhawa leaves (<i>Anegessus la'ifolia</i>)	12-20
Gothar fruit (<i>Zizyphus xylopyra</i>)	10-20
Goran bark (<i>Cerriops</i> and other mangroves)	18-25
Kahua bark (<i>Terminalia arjuna</i>)	12-18
Karaunda leaves (<i>Carissa opaca</i>)	8-10
Myrobalan nuts (<i>Terminalia chebula</i>)	27-45
Sal bark (<i>Shorea robusta</i>)	7-10
Sonari bark (<i>Cassia fistula</i>)	10-12
Green wattle bark (<i>Acacia decurrens</i>)	24-35

The most important tanning material for the processing of bag-tanned sole leather is a mixture of babul bark and myrobalan nuts in a ratio of 3 to 2.

Other mixtures are also in use, such as babul bark (50 percent), dhawa leaves (20 percent) and gothar fruit (30 percent); or dhawa leaves (20 percent), karaunda leaves (25 percent) and aonla twig bark (15 percent); and so are many other mixtures of local importance.



FIGURE 39. - *Bag tanning as practiced in Indian co-operative rural tannery. The buffalo hides are suspended from a beam, the liquor oozing into a cement vat from which bags are refilled.*

The babul tree is used for timber and fuel in northern India, and its bark has been easily available as a by-product. Unfortunately, many trees have been felled all over the plains; and now bark supplies are short. The recognized types of myrobalans are: Jubbulpores (Js), in the State of Madhya Pradesh; Rajpores (Rs.) and Bimlies (Bs), in the States of Madras and Bombay.

Babul bark is collected by villagers in their spare time from November to March. The best month in which to collect myrobalans is January. Earlier collection gives inferior fruit, and later gathering is unwise.

Fleshy myrobalan nuts with small stones are better than those with bigger stones; for the flesh is rich in tannins, while the stones contain less. It is an advantage, after they have been collected in the field, to crush the dried myrobalan nuts and thus to remove the stones. Adulteration, however, has taught the tanner to be chary. The crushed myrobalan would become more popular, if only adulteration could be more easily detected.

The nuts are highly valuable for fixing the color of hides and skins and, in particular, for the final treatment of the so-called "East



FIGURE 40. - *Bag tanning of goatskins as practiced in village tannery in Africa.*

Courtesy Kenya Information Office, Nairobi

India kips." Myrobalan tanning mixture, however, does not penetrate the hide rapidly. For this reason, it is used in mixtures with other tanning materials.

Babul bark should be removed as soon as possible after the felling of the tree. This can be done in one of two ways:

- (a) by beating the bark off with a wooden mallet; or
- (b) by making a single incision along the full length of the log and then — with a 20 to 30 centimeter long bone or spoon-like instrument — by loosening and by prying the bark off, as far as possible, in one piece.

When the bark is left too long on the trunk, the consequences are fermentation and a loss of tannins.

After the bark has been removed, it can be chopped into pieces not longer than 5 centimeters, spread out on the ground, and dried in the sun. For this purpose, the chaff cutter which is found on all village farms can be used. When the bark is to be kept in large pieces, these are placed tent-wise for drying and, for the sake of a sufficient air circulation, the outer side of the bark is made to face the sun. A tanner who owns a bark crusher prefers to buy bark in large pieces: for it is cheaper.

Initial bag tanning

To convert one pelt of about 20 kilograms in weight into bag-tanned leather suitable for the manufacture of shoes, a total of at least 40 kilograms of crushed tanning material is needed. In the initial tanning or *malni*, however, only 10 kilograms of a babul bark-myrobalan mixture — in the proportion of 6 kilograms of bark and 4 kilograms of nuts — is used.

The first *malni* liquor should be 5° Bkr. strong, and the strength is gradually raised to 20° Bkr. The period of this initial tanning process, which ranges from five to ten days, depends on the condition of the pelt, the efficiency of handling and the frequency with which the tanning liquor is strengthened.

The delimed hides are immersed in the tanning liquor and moved continuously. To accelerate this process, they are squeezed out regularly, and a fresh addition of tanning material is made every day.

In more progressive tanneries, the initial tanning process is carried out in paddle vats. The paddle blades are rotated by hand or, when engine power is available, by belt drive; and the regular strengthening of the tanning liquor is done by adding liquor which has been previously prepared in leaching pits.

After this initial tanning, and to accelerate bag tanning, the hides are squeezed out so as to reduce their moisture content.

For bag tanning, it is a definite advantage to leave all hides, buffalo or cow, as complete hides and to pretan them, if necessary, in a folded condition. The folding is done along the backbone line with the grain side in (Figure 41).

They are then sewn into bags with a sharp, strong awl and fibrous string. The stitching starts from the tail towards the hind shanks, which are left open. It continues from the open shanks along the entire hide (Figures 42 and 43). The stitches are at a regular distance from the edge. Great care is needed to ensure that the underlying side or piece of hide does not slip away, for this causes a weak or a broken seam. The size of the stitch varies, according to the thickness of the skin or the hide, from 0.5 to 1 centimeter. The edges are butted together with a so-called "zig-zag" stitch. This method of sewing produces a seam capable of withstanding the load and the pressure which the tanning material imposes.

Leather-sewing machines are not in use. Yet, in an advanced rural tannery, where many hides are handled every day, these machines could create a large saving in time.

When the sewing is completed, the bag is turned grain side out by pulling the hide through the open hide shanks. The bags are then suspended over a collection pit and filled through the open top with vegetable tanning material. In all, about 13 kilograms of babul bark and 10 kilograms of myrobalan nuts — all crushed — are required for this second stage in tanning. The tanning liquor derived from the last solution used in the initial tanning stage is also poured into this opening. The pouring continues until the bag is half full.

The tanning material is leached out inside the bag, and its strength increases gradually to 25° or 30° Bkr. The tanning liquor percolates, and it is collected in the pit below the hanging bags. The level of the tanning liquor in the bags is maintained by filling them regularly — three or four times daily for three days — with the liquor collected

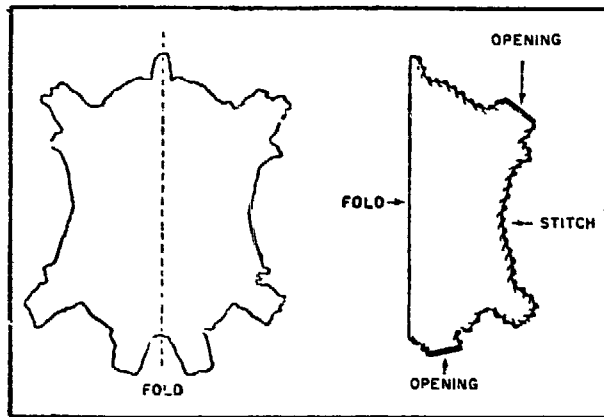

FIGURE 41. - *It is an advantage to leave hides complete, folded down the back line, then to sew edges together.*

in the pit. After three days, the bottom is opened and the top of the bag is sewed up. The bag is inverted and refilled with tanning materials and tanning liquor. Another three days are needed for completing the tanning process. Sludge deposits which show on the grain side are wiped away daily, in order to prevent stains. Then the bottom is opened; the tanning material and liquor are removed; and the adhering tanning material is washed away with the tanning liquor.

Finally, the entire bag is opened by cutting away the fibrous stitching strings; and the leather is washed superficially and piled down.

Unfortunately, leather at this stage is often undertanned and although it may be sold by tanners in need of immediate returns, it does not fetch a good price on the market. In organized rural tanneries a more fully tanned leather is produced by layering the bag-tanned leather in pits. This is often followed by some light extract tanning in drums.

Layering

The opened bag-tanned leather is spread out flat in a pit; sufficient tanning material is dusted in between the pieces; and the whole is covered with a liquor of at least 35° Bkr. and left for a minimum period of seven days.

This layering can be extended by enriching the pit weekly with a fresh tanning mixture, thereby also increasing the yield of the leather. Tanners who wish to allow only one week for layering use about 7 to 10 kilograms of crushed myrobalan nuts for hides weighing 20 kilograms each.



FIGURE 42. - Bag tanning arrangements, showing how two sides are sewn together to form a bag.



FIGURE 43. - Sewing hides together is widely practiced in Indian villages.

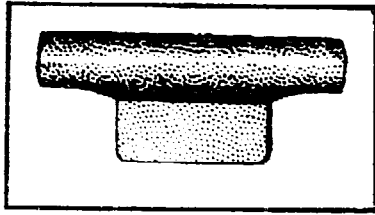

FIGURE 44. - *Setting out tool — stone embedded in wooden handle.*

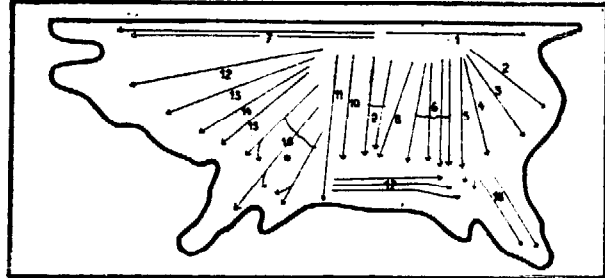

FIGURE 45. - *Setting out manually is practiced on setting table. Sketch shows direction of strokes and scheme of setting.*



FIGURE 46. *Setting leather by hand while still in moist condition, as practiced in advanced and organized rural tannery.*

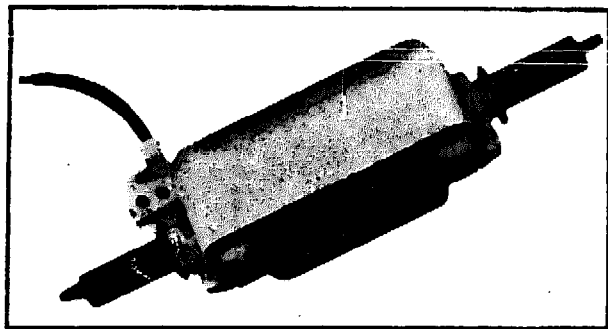

FIGURE 47. - *Self-contained electrically-operated hand-setting apparatus which can be used to advantage in tanneries.*



FIGURE 48. - *Worker with self-contained electrically-operated hand-setting apparatus.*



FIGURE 49. - *Sketches of slickers which can be made of brass, steel, glass or hard wood.*

Courtesy Mrs. Erica Mann

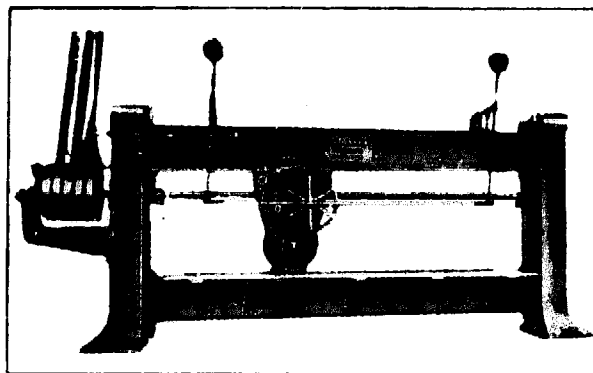

FIGURE 50. - *Sole leather rolling machine with belt drive for heavy sole leather.*

Finishing

The tanned leathers are piled for some period; they are washed and struck out to remove uncombined tans, sludge and so on; and they are hung up for partial drying in the shade.

Care is needed to prevent tanned leathers from becoming hot in the pile; otherwise they cannot be used.

Tanned leathers are first set when they are still in a moist condition. They are then dried again. As soon as a leather has lost about 50 percent of its moisture, another scouring and setting takes place. A scouring stone embedded in a wooden handle is used (Figure 44).

Figure 45 indicates the direction of the strokes and the method of setting (see also Figure 46). In more advanced tanneries, where electric power is available, a self-contained electrically operated hand-setting machine can be used with advantage (Figures 47 and 48).

Later the leather is oiled with a mixture, which has been prepared by adding 250 grams of linseed oil to 7 liters of boiling water. This mixture is cooled down, and 0.75 liters of milk can be added to improve the finish of the leather.

Rural tanners also use sesame oil, which they sprinkle over both the flesh and the grain sides.

After a complete drying, the leather is polished with a tool which is devised to squeeze out the moisture, to compress the grain and to smooth out the wrinkles. This tool is called a "slicker." It consists of a wooden handle, 20 to 25 centimeters long and 2 centimeters thick, into which is set a 60 millimeters wide piece of glass or brass. A less durable slicker can be made entirely of hard wood (Figure 49).

Heavy leather, while still in a slightly damp condition, can be rolled by a small cart which is loaded with heavy weights and which is provided with a brass roller. More advanced rural tanneries use sole-leather rolling machines (Figure 50).

When bag-tanned leathers are treated in the manner which has been described in this chapter, they have not only a better finish; their compactness and their resistance to water and to wear are greatly increased. Accordingly, their value is substantially enhanced.

VIII. VEGETABLE TANNING OF LIGHT LEATHER

Sheepskins and goatskins

As a rule, the rural tanner depends on tanning material which he obtains locally rather than on commercial concentrated extracts. It is difficult, therefore, to give strict rules and recipes for tanning.

The basic principles are given in this chapter only as a guide. They should be modified in the light of results. Tanning of light leather is simple if there is a strict adherence to these two basic principles:

1. to start tanning in weak liquors and gradually increase the strength until the process is completed;
2. to help the tanning mechanically by pulling, turning over and rocking.

Under rural conditions, light leather can be tanned in three different ways:

- (a) in one pot or vat, in which the original liquor is gradually strengthened; or
- (b) in several pots or vats, where the skins are transferred from weak to stronger liquor; or
- (c) in a drum or paddle, in which the process is greatly speeded up.

IN ONE VESSEL

Sheep- or goatskins should be tanned separately because goatskins require rather longer tanning than do sheepskins. The skins are merely immersed in the pot or vat (Figure 51) in an initial



FIGURE 51. - Small village tannery where only one vat is used in tanning operation. The skin is suspended from a stick and taken out at least four times a day.

Courtesy Kenya Information Office, Nairobi



FIGURE 52. - Small village tanneries can utilize an earthenware pot for skins which are pulled and stretched to obtain a uniform penetration of tan liquor.

Courtesy Kenya Information Office, Nairobi

liquor which does not exceed the strength of 2° Bkr. Each skin should be suspended by at least three strings — one at each hind shank, and one at the tail — from a piece of wood which rests across the top of the vessel. In this way, touch marks called “kisses” are avoided. This method is better than piling crumpled skins into the liquid in a disorderly state; for crumpling causes “drawn grain” — for example, permanent creases in the grain.

At least four times a day the skins should be taken out (Figure 52), pulled and stretched.

Each day a fresh and stronger solution of tannin is added, so that on the second day the strength is 4° Bkr.; on the third day it is 6° Bkr., and so on. This continues until the skins are tanned completely.

In order to see whether the skin is completely tanned all through, the leather is cut with a clean sharp knife on the thickest part, and the cut section is inspected. If the color is uniform throughout, the process of tanning is finished. If a light-colored streak is visible in the center, the tanning is not complete, and it must be continued.

IN MORE THAN ONE VESSEL

Instead of adding increased quantities of tannin to the same vessel, it is better to have a series of vessels of increasing liquor strength. This method is specially advisable for tanners who have more than one or two skins to tan at a time; for it permits a continuous process. The first vat is filled with a liquor of 2° Bkr., the second with a liquor of 4° Bkr.; and the final vat has a liquor of 8° to 10° Bkr. It is sufficient to keep sheepskins for two days in each of these vats, so that they are tanned in eight days. Goatskins, on the other hand, stay for three days in each vat, and they are finished in 12 days. Here again, the more often the skins are taken out, stretched and pulled, the more thorough will be the tanning.

TANNING IN A DRUM OR PADDLE

Almost all the operations performed by the tanner can be done more cheaply, more quickly and better if the goods are stirred or moved continuously. The best way to achieve continuous movement

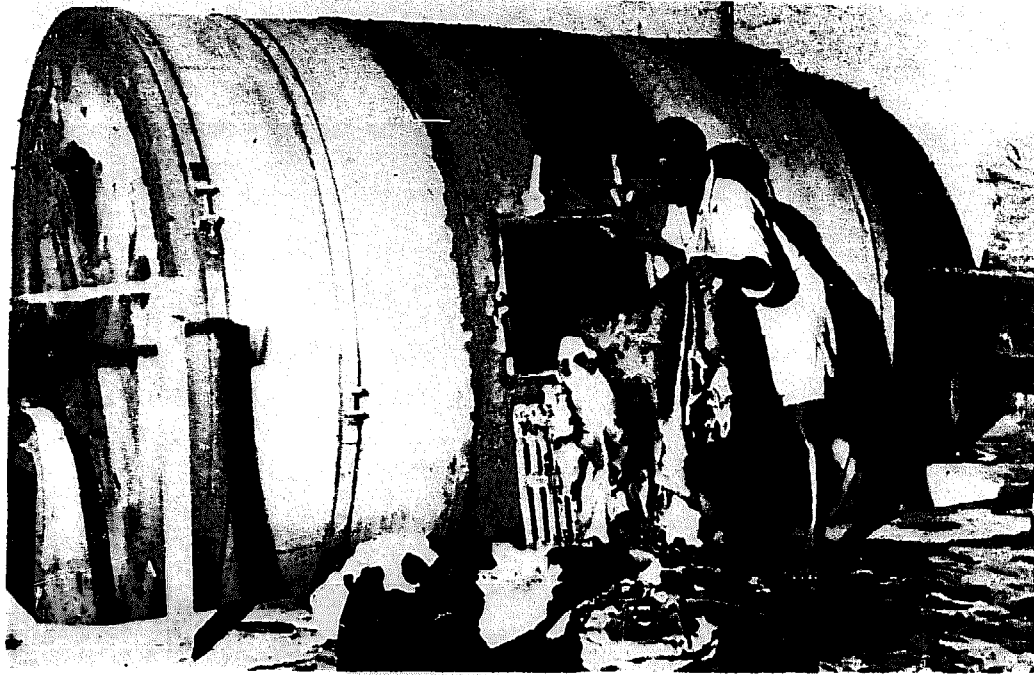
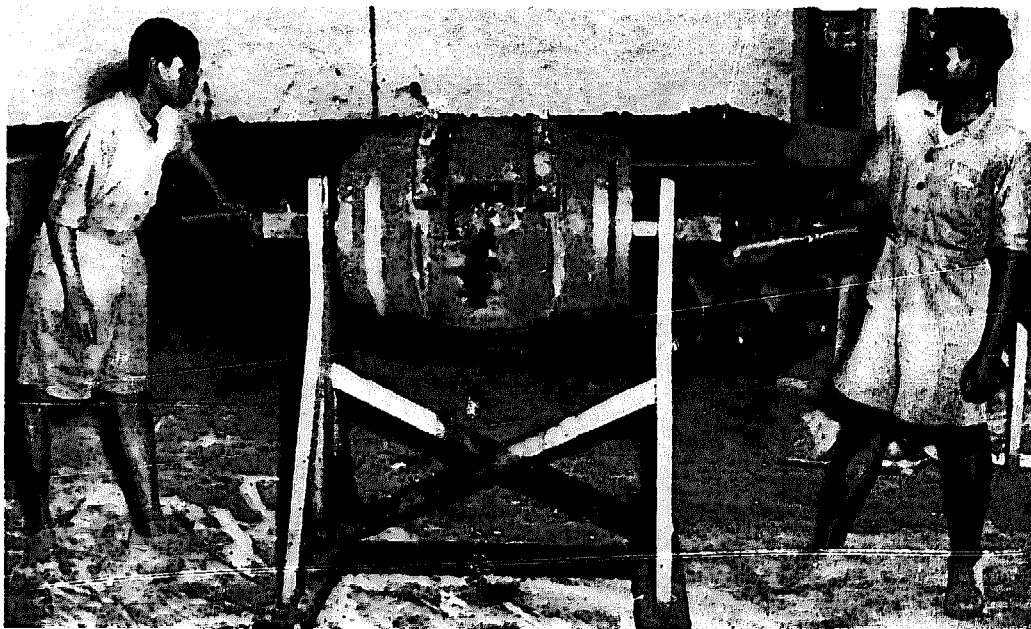

FIGURE 53. - *Power-driven drum as used in large tannery for washing and liming.*
Courtesy Kenya Information Office, Nairobi

FIGURE 54. - *Hand-operated tanning drum made locally from cask and which can be used in rural tanneries.*
Courtesy Kenya Information Office, Nairobi



of the goods and the liquor is in a drum (Figure 53) or paddle (Figure 36). Every large tannery has a battery of drums and paddles which are used for nearly all the processes, such as soaking, liming, deliming, tanning, dyeing and fat-liquoring. When a rural tanner cannot afford power, he can certainly make for himself a small hand-operated drum (Figures 54 and 55).

Oil or petrol drums are useless, unless alum tanning only is practised; for iron combines with the tannin, and this causes a blue or a green discoloration. Wooden casks, therefore, should be used. Old sherry or wine casks of 200 to 300 liters' capacity are the best, but the iron hoops must be removed and replaced by wooden or brass ones, or raw leather straps, and fixed with nonferrous nails. An old butter churn, provided there are no iron parts, can be used instead of a drum. The stub axles are fastened to the top and bottom of the cask, and they rest on two crossed legs, as shown in Figure 55.

FIGURE 55. - *Sketch of hand-operated locally made tanning drum.*

Courtesy Mrs. Erica Mann

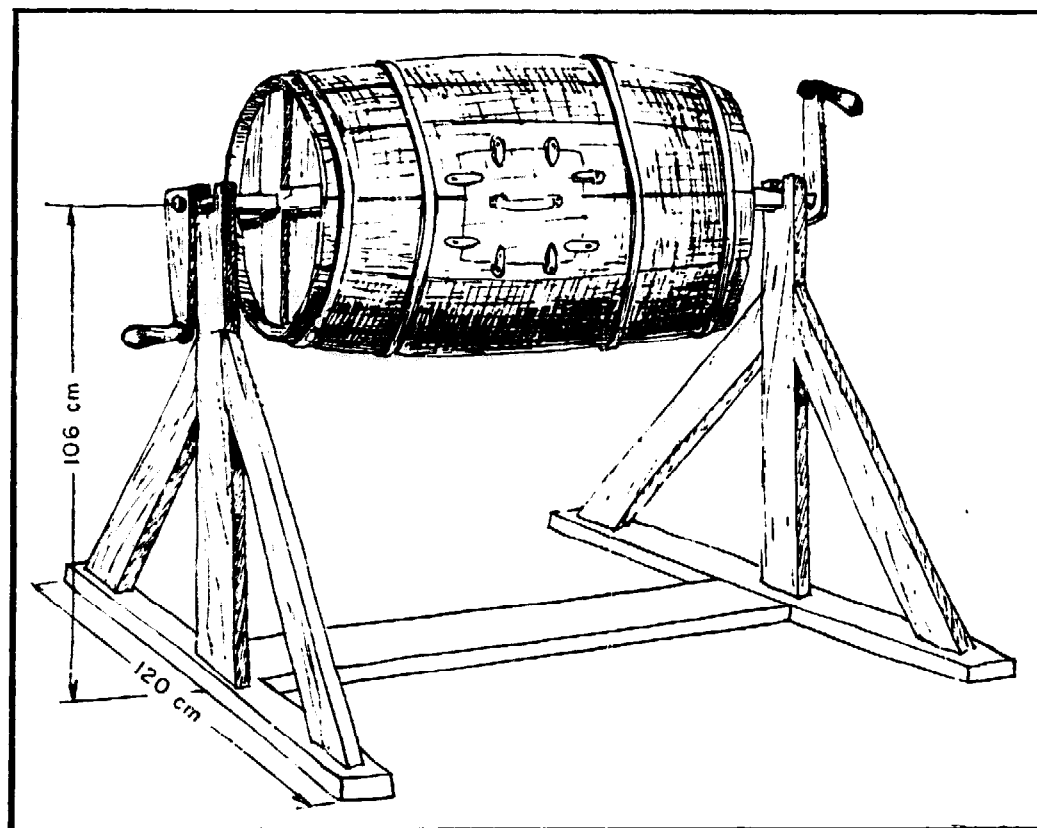

Two handles, one at each end, enable the operators to turn the drum with ease, even when it is full of goods. A removable door as water-tight as possible can be made by cutting a rectangular or circular piece from the body of the cask. The door is fitted with strong wooden fasteners to keep it in place while the cask is rotating. Strong wooden round-ended pegs are also fixed in staggered formation inside on the drum walls. This is done to promote the lifting and the falling of the rotating skins.

The tanning operation is carried out in the following manner.

A stock solution, which contains 5 percent tannin, equal to a strength of 15° Bkr. is made up and divided into ten equal parts. The skins are put into the drum. They are covered with water, and 5 kilograms of salt are added to each 100 kilograms of wet skins. After drumming for a quarter of an hour, the first part of the stock solution is added. Drumming then continues for another 45 minutes, and a further part of stock solution is added. This addition of stock solution and drumming is repeated four times — in other words, until half the stock solution has been used. The skins are then stretched, squeezed out and piled, one on another, over a wooden horse. In the meantime, the sixth part of the solution is added to the liquid in the drum. The skins are then returned to the drum and drummed again. Every 45 minutes, further parts of the stock solution are added until all has been used.

A similar process can be adopted for paddle tanning.

Rapid East Indian tanning of sheepskins and goatskins

The method of tanning sheepskins and goatskins, which is now described, has been developed by the Central Leather Research Institute in Madras.

The wet salted goat- and sheepskins are weighed and put in plain water, with the flesh side up, for two to three hours. When the skins are sufficiently soft, they are cut open and given three to four changes of water. Between each change they are well trampled. The well-soaked skins are then drained and weighed.

Now a paste, which contains one part of sodium sulphide (60 percent fused), 16 parts of lime and enough water to make it smooth-flowing, is prepared, and it is applied on the flesh side of the skins.

The painted skins are then piled, flesh to flesh, and covered with gunny.

As a rule, for the wet salted stock of 100 kilograms, a paste composed of 1 kilogram of sodium sulphide, 16 kilograms of lime and enough water to make it smooth-flowing is sufficient. After six hours, or after overnight, the painted skins are unhaired. They are then put into a lime liquor which contains half of old liquor, half fresh water and 5 percent lime, based on the wet salted weight.

The goods remain in this liquor for two days, and they are handled daily. On the third day, the skins are scudded and put in a lime liquor which contains fresh water, 10 percent lime and 57 grams per hundred caustic soda, both based on the wet salted weight.

The skins are handled daily in this liquor, and they remain there for three days. On the fourth day, they are fleshed, and the fleshed weight is taken. The fleshed skins are then trampled well in water. After a scudding, they are put in plain water overnight. On the fifth day, after they have been well trampled they are fleshed, scudded twice and delimed fully with 0.5 percent boric acid, based on the fleshed weight. The cut section is tested with a 1 percent alcohol solution of phenol phthalein. The delimed skins are scudded, washed twice and are ready for the petreatment with commercial sodium acetate and sulphuric acid. The delimed and washed skins are trampled in a pit which contains a minimum amount of water to cover the skins — that is, 100 to 150 percent of water, based on the fleshed weight; 0.75 percent to 1.125 percent sulphuric acid (specific gravity 1.84) is taken and diluted, and the acid is added in three installments at an interval of half an hour; and meanwhile the goods are trampled all the time. The pH of the bath is adjusted to 4.8 to 5, as tested with the indicator paper.¹ The goods are left in this solution overnight, and the pelt is kept well immersed in the liquor.

Next morning, after a good trampling, the pH is again tested to see whether it is constant at 4.8 to 5. If not, the bath is adjusted, and the goods are trampled to attain an equilibrium pH 4.8 to 5. The whole operation can also be carried out in a drum, with one to one and a half hours drumming.

¹ See Appendix on "pH Value in Tanning."

The following five points need to be emphasized.

1. At no time should the sulphuric acid be added to the goods. The goods should be first removed. The sulphuric acid, which is diluted, is then added and well mixed.
2. As a rule, 0.75 to 1.125 percent sulphuric acid, based on the fleshed weight, is sufficient to attain an equilibrium pH of 4.8 to 5 for delimed goods.
3. It is essential that the pH should be adjusted to pH 4.8 to 5 in the cut section of the skins as well as in the bath.
4. In treating with sulphuric acid, the pH of the bath suddenly goes down, but it increases again as the pelt is neutralized. Repeated additions of the acid are, therefore, necessary to adjust the bath.
5. The pH may be readily tested by using either narrow range indicator papers or a pH meter.

Another pretreatment is given by using calgon, a material to obtain soft water, and sulphuric acid. The delimed and washed goods are trampled in a pit which contains a minimum amount of soft water to cover the skins — that is, 100 to 150 percent water, based on the fleshed weight, 2 percent calgon and 0.75 to 1.25 percent sulphuric acid for a period of two hours. The acid, after it has been well diluted, is added in three installments at an interval of half an hour. The other procedures are the same as in the pretreatment which has been already described, except that there the pH has to be adjusted to 2.3. The five other points already mentioned should also be followed here and the equilibrium pH of 2.3 should be obtained. The cut section of the goods pretreated with calgon should be white. The calgon pretreated goods are repeatedly washed with water free from acid, and two or three changes of water are sufficient.

The whole operation can also be carried out in a drum with one to one and a half hours drumming. Either of these two pretreatments can be followed.

Vegetable tanning carried out in the traditional way and by using the two-pit system. The amount of tanning material required is worked out, as usual, from the expected yield. With avaram bark,

about 1.5 to 3 kilograms of bark per kilogram of expected yield are used, and the quantity is given equally between the first and the second bark tanning operations. With wattle bark, the amount is 1.25 to 1.5 kilograms per kilogram of expected leather yield. Tanning can also be done by using different tanning materials which are blended in suitable proportions.

With avaram, the type of bark which is good colored — that is, with a greenish tinge at the fracture — is rinsed twice with fresh water as quickly as possible. The required quantity of the bark is soaked along with half of old liquor and half fresh water in a pit or tub about 24 to 48 hours before the goods are brought to the tan yard. If wattle bark or extract is used with avaram, it is also soaked together with the avaram bark.

The pretreated skins, which are drained, are then immersed in the liquor. In the treatment of the skins, they are drawn individually once or twice through the liquor, and then they are piled and pressed in the pit. The liquor is then stirred up and the skins are once again drawn through, one by one, and piled in the pit. They are well pressed, while keeping half the bark at the top and the other half at the bottom. The goods are left overnight. On the next morning and in the following evening, they are again hauled and piled to ensure an even color. On the third day, they are worked over the beam on the flesh side with a blunt scudding knife. This sets the grain smooth and flat and gives the skins the required shape. During beaming, care should be taken not to expose the skins for a longer period, if discoloration is to be prevented. Beaming should be such that the goods are free of growth marks, wrinkles and folds. After beaming, the skins are put in the liquor. Here the skins are kept in pairs, grain to grain, and bark is sprinkled between each pair. Some bark is kept at the top and some at the bottom. Sometimes the bark is also sprinkled between each skin. The skins are well pressed inside the liquor, so as to avoid air bubbles and unevenness in the color of the leather. Similar handling is done on the fourth and the fifth days.

On the sixth day, the skins are wrung out, beamed on the flesh side and put in the second bark solution, which is prepared in just the same way as the first one. The goods are handled in the way which has been already described: and here they remain for another five days.

The tanned skins are then wrung out, and bleached in the usual manner; and the skins are trampled in a bleaching syntan for about 15 minutes. For every 100 kilograms of expected leather 1 to 2 kilograms of syntan are used. The bleached goods are rinsed in the same bath by adding more water. They are then beamed on the flesh side. The beamed skins are ready for myrobing.

The myrobalan bath is given in one installment for a total period of two days. On the whole, 360 grams of good quality myrobalan per kilogram of expected leather are taken, and the crushed myrobalan nuts are soaked in hot water (55° to 60° C.) at least 18 hours before they are used. The overnight soaked myrobalan nuts are then trampled. Sufficient cold water is added to extract more tannin from them and also to bring the liquor to a proper dilution (30° to 40° Bkr.), so as to get a yellow color on the flesh side of the skin after it has been dipped in the bath. The skins are dipped one by one in this bath and piled in another empty tub nearby. When all the skins are piled and well pressed, the liquor is poured over them. Care is taken to avoid any formation of air bubbles. The skins are kept in this second tub for a short time. They are then removed one by one, piled in a third tub and well pressed. The liquor is again poured, and the goods are left in it overnight. Next day, another handling is given in the same way. On the third day, the skins are rinsed in the same bath by adding more water; they are beamed on the flesh side and piled for oiling. The final working over the beam is done carefully to obtain the best pattern and the correct moisture content.

The beamed skins are then piled on an oiling table, while keeping the grain up. Each skin is then oiled by sprinkling a good quality of oil — as a rule, this is gingelly oil or ground nut oil — and, if necessary, a little amount of water. The oil is then evenly applied on the grain of the skins. The oiled skins are kept in another pile. They are again rubbed three or four times, and hooked in a cool place. When the skins are in a sammed condition, they are conditioned and piled in a wooden tub and covered with a gunny or palm leaf. They are left overnight to equalize moisture. They are then set twice on a glass or marble table and allowed to dry in a dark cool place. The dried skins are weighed to calculate their yield, and they are piled for a day or two.

As a rule, they are staked and fluffed on the flesh side; they are trimmed and graded in the usual manner.

Their physical characteristics like general appearance, color, feel, fullness, crackiness and tear strength are comparable with the traditional E. I. tanned skins, while the yield is 40 percent on the fleshed weight.²

Calfskins

Calfskins, although they are thin, are not easily tanned as those of sheep or goats. Wherever vats are available for the tanning of sides, they should also be used for calfskins. Here follows a simple method for rural tanneries which handle calfskins from animals under six to eight months.

1. Immerse or, better still, suspend the skins in an old liquor of approximately 3° Bkr. and "handle" as frequently as possible. Handling means taking the skins out and carefully stretching, pulling and kneading them. In this way, the moisture is squeezed out, and the calfskin will the more easily absorb further tanning liquor. The skins should be stirred often by hand or with a wooden paddle, so that they do not touch each other for long periods; otherwise the points of contact will be discolored. The skins should remain in the first liquor for one or two days.
2. Transfer the skins to a stronger liquor, or increase the existing liquor to a strength of 6° Bkr., and handle frequently for three days.
3. Strengthen the liquor, or transfer to the next liquor of 9° Bkr., and leave for four days.
4. The last tan liquor should have 12° Bkr., and the skins are left for five to eight days in this liquor until they are colored right through. For thicker skins from older animals, an even stronger liquor will often be required, unless the time for tanning is lengthened by one to two days in each vat. The "kneading" operation, however, must be done with care; otherwise the result may be a distortion of the grain and "loose grain."

² See also Chapters IX and X.

IX. FAT LIQUORING, OILING AND STUFFING

After the hides or skins have been tanned, they require further treatment to improve their quality and appearance. The basic principles of this treatment aim at:

- (a) removing excess uncombined tannins — in particular, from the grain and flesh surfaces;
- (b) adding fats and oils to make the goods more pliable and water-proof;
- (c) softening or hardening the goods as required; and
- (d) improving the appearance by applying a finish.

Excess tans and non tans, however, are not removed from sole leather, apart from the flesh and grain surfaces, because this would mean a reduction in weight and solidity.

These operations differ according to the type of leather and its future use. In this chapter, therefore, the treatments of light, heavy and sole leathers will be considered separately.

The treatment of sole leather is described first because it is very simple and because it offers a basic method for the treatment of other types of leather.

Sole leather

After the bends are removed from the vats, they require a further careful treatment.

PILING

In order to absorb and fix any uncombined tannins and to lose excess moisture, the bends are piled one on top of the other and completely covered with tarpaulins or wet sacks. They should be left for a minimum of 48 hours.

SCOURING

When tannins which contain pyrogallol are used, such as myrobalans and chestnut, a certain amount of "bloom" is deposited inside the leather and on the grain. The bloom and the surface tannins should be removed by "scouring." This the rural tanner can do by using a sloping table which inclines away from him. The bloom is removed with a stone or slate slicker and well washed off with water. This process should also be adopted for catechol-tanned leather — wattle-tanned leather — but washing both surfaces with water should be sufficient. Without adequate scouring the dried leather will be "off color" and cracky.

OILING

To prevent cracking and to make the leather more waterproof, the bends are then oiled. The best are cod and sulphonated oils. Another important reason for oiling sole leather is that the oil prevents oxidation of the surface tannins, thereby greatly improving and preserving the color of the leather when it is dry. The tensile strength is also increased.

DRYING

The rapid drying of leather by exposure to the sun or to very hot air is injurious; for it causes shrinkage, hardening, cracks and discoloration.

The speed of drying depends on the moisture content, temperature, humidity and circulation of air. To be independent of these factors,

large tanneries use a dark, properly ventilated and heated drying room, where the leather is dried under ideal conditions. Even the rural tanner will need a dark, properly enclosed space where he can dry his leather away from the sun, rain and excessive wind.

After oiling, the bends are transferred to this drying shed and hung on hooks or on two pieces of string.

SETTING OR STRIKING OUT

When the leather is half dry, it is taken from the drying shed. Dry grain patches are wetted back and the leather is piled to "samm" overnight (see page 125). Next day the leather is worked on a table with a brass or glass slicker (Figure 49). If the leather is too wet, the grain will not stay "set."

If parts of the bend have dried out during "samming," they should be remoistened, so that the whole piece is damp and soft.

The work should start on the flesh side, so that the surface is smooth, the leather set out and as much moisture as possible removed. A "bottom finish" is now applied to the flesh side by means of a hard brush and then smoothed by hand. The bend is then turned over and the grain side treated with a coat of linseed or any other suitable oil. Afterwards it is hung again in the drying shed.

ROLLING

During drying the bends should be continuously examined and only taken down with a little moisture when the "color is up." This minimum moisture is very important; for it allows a binding and firming action when the bends are rolled under pressure. Before rolling, the bends are normally piled overnight to "samm," but the dry edges are first wetted to even out the moisture. Placing heavy weights on top of the pile has obvious advantages.

In a large tannery leather is rolled by a special power-driven machine. Here a brass or stainless steel roller moves under pressure over a smooth surface. The bend is put in between the surface and the roller which, by moving backwards and forwards, rolls the bend flat (Figure 56).

A stone, tennis-court roller can be used under rural conditions, provided it has a very smooth surface. As a rule, however, this does not give sufficient pressure. A more satisfactory way of improving the quality of the leather is to use a section of the trunk of a hardwood tree, 30 to 45 centimeters in diameter, as a block. On this block the leather is laid flat and beaten evenly with a heavy wooden mallet (Figure 57).

FINAL DRYING

Final drying now takes place in a more open, but shaded, position, or near a stove, where less harm can be done.

If additional firmness and "finish" (polish) are desired, the bends could be rolled again and then finally dried. Two rollings are termed "rolling on" and "rolling off." "Rolling on" is done with more moisture in the leather than is "rolling off."

Heavy upper and dressing leather

Once the treatment of sole leather is mastered, the work on other heavy leather should present no difficulty.

PILING

The period of piling may be reduced and should not exceed 24 hours, for the leather is normally thinner than sole leather.

SHAVING AND SPLITTING

A reduction of the leather to an even and predetermined thickness is obtained by hand shaving. As a rule, this follows tanning, and it should be done before any other process. The beam which is used has a flat working surface, and this is inclined at an angle of about 10 degrees off the vertical. The wet "sammed" leather is placed over the beam and held by the pressure of the operator's

abdomen. The shaving knife is double-edged, and it has two handles; one horizontal, and one vertical. The vertical handle moves along the edge of the beam, and thus it gives the operator a guide and support. The blades with turned edges must be extremely sharp before the shaving begins. This very delicate operation requires skill and patience. Those who are unaccustomed to the work may harm the goods rather than improve them. Figure 58 shows a modern shaving machine, as used in large tanneries.

An inexperienced tanner is advised, therefore, not to attempt to shave leather, but to leave the sides unshaved. The shoemaker and the leather craftsman will then be able to select those parts of the sides which are best suited to their particular requirements.

When a hide is hand-shaved, the small pieces of leather shaved off are normally useless to the rural tanners. There are, however, machines which prevent this waste by splitting the hide into two or more even layers and by leaving the grain portion with an even and predetermined substance. The other layers are called "splits" and, as they have less value, they are used for cheap upper leather, linings or similar purposes.

SCOURING

The next operation is to wash out all superfluous tan. It is essential that no excess tan is present when leather is subsequently fed with grease; otherwise a "dead" feel will be imparted to the finished leather. At this stage it is necessary to "clean" the grain with a brush and with a weak and warm solution of oxalic acid. Ample scouring with water completes the operation.

STUFFING

Sole leather which has to be firm requires little oiling. Only one or two applications to the grain side are, therefore, necessary. Leather for belting harness, upholstery or uppers, however, must be pliable and soft, and a much heavier application of oil is required. The more pliable the leather has to be, the more fat should be incorporated. Here is a simple recipe. To one third soap, shredded very finely, add a sufficient coverage of water; heat until the soap is dissolved,

FIGURE 56. - *Type of power-driven roller suitable for advanced tanneries.*

Courtesy Kenya Information Office, Nairobi



FIGURE 57. - *Beating sole leather on wooden trunk with a mallet can improve the quality of the leather.*

Courtesy Kenya Information Office, Nairobi

FIGURE 58. - *Modern shaving machine as used in large tanneries.*



add one third tallow and stir continuously until the mixture is homogeneous; to this add one third of any available vegetable oil: take from the fire and continue stirring until there is a uniform mass which resembles soft butter. The completed mixture should be only applied to the flesh side.

When the stuffing is finished, the side is taken off the table, which is then thoroughly cleaned. The grain side of the hide is cleaned — in particular, around the edges — set out with a brass or glass slicker and oiled. The last results are obtained with fish oils, but sesame, groundnut, cotton seed or any other vegetable oil can be used.

Where a very pliable leather is required, stuffing can be repeated after the leather has been hung up for several days to dry. The goods must be brushed with warm water. After they have been evenly wetted and wiped, the stuffing is applied once more.

DRYING

After stuffing, the leather is carefully hung in the shed to dry.

REMOVAL OF EXCESS FAT

When the leather is completely dry, a considerable amount of fat will still be left on the surface. To further the absorption of fat, the leather pieces should be placed, flesh side to flesh side, flat on the floor and covered for 10 to 14 days. After this period of "ageing," the leather is taken out and again spread on the table, and the operator works with a slicker to scrape off any excess fat. This fat should not be rejected, for it can be used with the next bath of stuffing material. It is now, however, different in its composition, for it has lost its low melting constituents.

SOFTENING OR BOARDING

If the leather is still hard, it may be softened or boarded, not by passing over a staking slicker, as is done with light leather, but by working over with a tool called an "arm board," or a "graining board," shown in Figures 59, 60 and 61.

FIGURE 59. - Sketch of tool called an "arm board" or "graining board."

Courtesy Mrs. Erica Mann

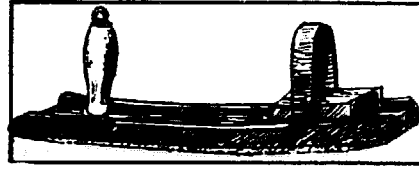
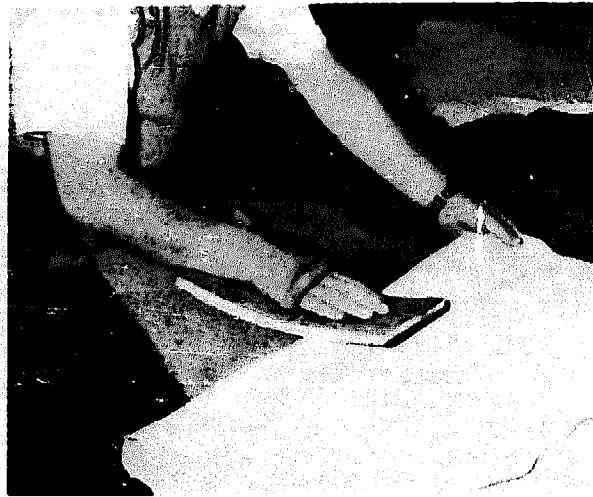

FIGURE 60. - Hand-operated graining board covered with cork layer: length 28 cm.; breadth 18 cm.; height 2.5-3 cm.; cork layer 1/2-1 cm.

Courtesy Marocchinerie e Scamoscerie Italiane, Turin

FIGURE 61. - Operator working with graining board. This operation is called "boarding" or "graining."

Courtesy Marocchinerie e Scamoscerie Italiane, Turin



PILING

When the skins are taken from the tan liquor, they are piled on a flat table and covered with a tarpaulin or sacks and left overnight to drain.

WASHING

Any uncombined tannin must be completely removed; otherwise the skins will be hard and dark. Washing for a few minutes under running water, or at least in a vat with warm water, is strongly recommended.

FAT LIQUORING

There is a marked difference in the amount of fat required for sheepskins and goatskins. Sheepskins contain more natural fat and may need as little as 2 percent, while goatskins may require double the amount. Goatskins are an exception, and they may be finished like heavy leather by applying a stuffing material to the flesh side prepared from one third soap, one third tallow and one third vegetable oil.

The following method used by the Hausa tanners in Nigeria is recommended; for, although it is primitive, it gives good results.

A few skins at a time are put into a wooden mortar together with groundnut oil and a little water. The skins are gently pounded with a wooden pestle; and, from time to time, they are lifted clear of the oil, returned and pounded again. After fat liquoring the skins are piled, flesh to flesh, and left overnight, or, preferably, for 24 hours.

DRYING

Drying should take place in a semidark and well ventilated shed. After the skins are completely dry, they should be left in the shade for two or three weeks to "age."

STAKING

Staking is the name given to the process of softening light leather by working it over a kind of slicker. This is a piece of rounded blade which is fixed vertically on the top of a wooden post and called a stake (Figures 62 and 63). The process requires great skill and care.

The operator must feel those parts which are thin and require more gentle treatment if tearing is to be prevented.

The operator puts the leather, flesh side down, on the edge of the blade, which is then worked backwards and forwards with the required downward pressure (Figure 64).

Leather for staking should be slightly damp. With practice the operator will be able to judge the correct condition. Dried out leather may easily tear during this operation.

It is advisable, however, not to soak the leather in water, but to "condition" it by covering it with damp sawdust overnight. This results in an even moisture content (Figure 65), and the process is called "samming."

During staking the skins are slightly stretched. For alum tanned goods, however, fuller stretching is essential to accentuate the whiteness and to bring out the quality of the alum tanned leather. After staking the skins are returned to the shed for final drying. Large tanneries use staking machines (Figure 66).

FINISHING

After being neatly trimmed, the goods are ready for finishing, and the methods are described in Chapter X.

Further details on fat liquoring and stuffing

Although fat liquoring and stuffing have been already briefly discussed, some additional information is now given on these operations, which are delicate and difficult.

Most of the natural fat present in the derma, it has been already stated, is removed by liming and bating. This loss of fat causes the leather, after tanning, to be hard and stiff and to have a tendency to crack. If the tanned fibers are lubricated by oil or fat, they flex easily and the leather is more pliable.

Artificial lubrication with fat or oils is called fat liquoring for light leather such as from sheep-, goat- or calfskins, oiling for heavy sole leather and stuffing for belting and harness.

The purpose of replacing the natural fats by fat liquoring, oiling



Figure 62. - This device, called a "stake," is used to soften leather by working it over the stake.

Courtesy Marocchinerie e Scamosc'erie Italiane, Turin

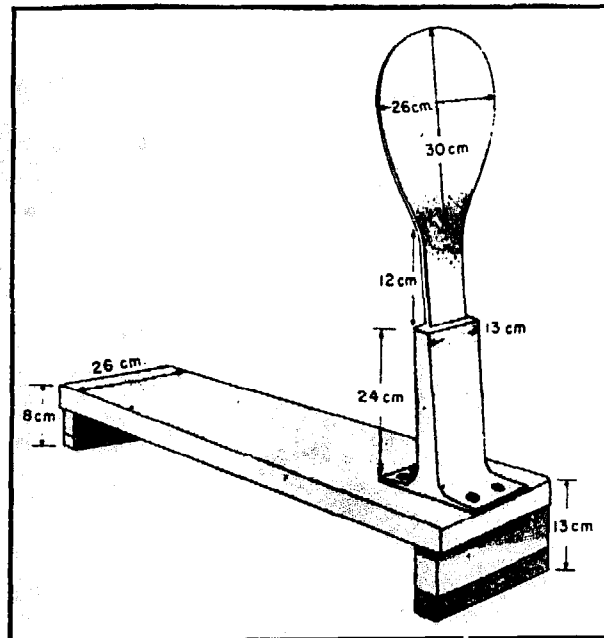

FIGURE 63. - *Dimensions of the stake in Figure 62.*

FIGURE 64. - "Staking operation." Operator working the leather flesh side on the stake over the blade, by pulling backward and forward with required downward pressure.

Courtesy Marocchinerie e Scamoscerie Italiane, Turin

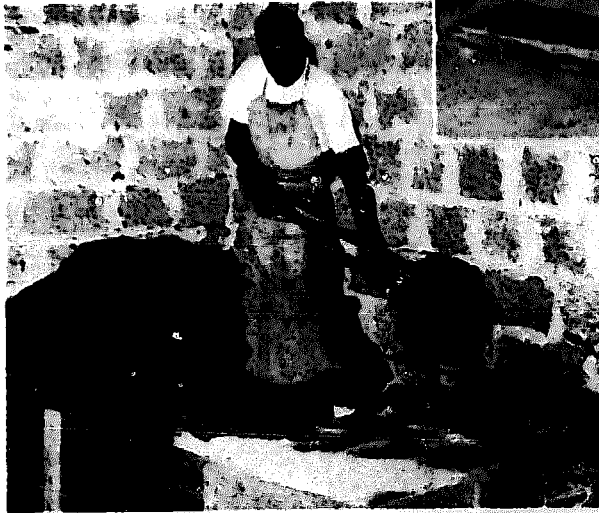
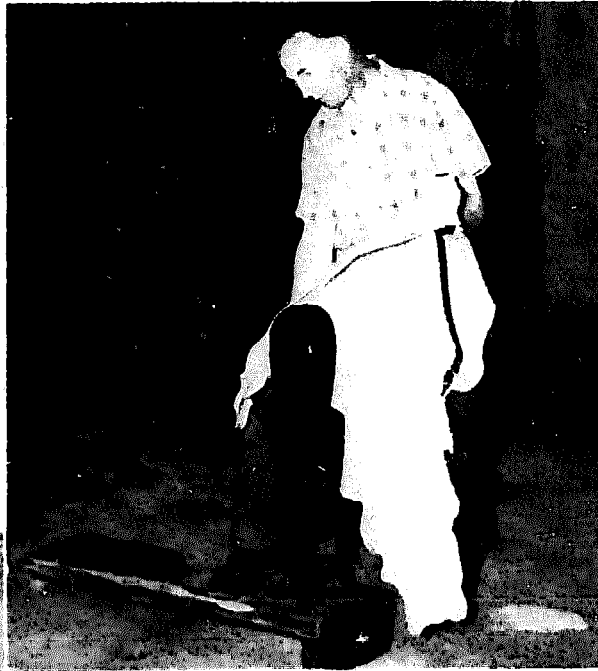

FIGURE 65. - Upper leather is placed into slightly moist sawdust, to acquire the correct moisture content required for staking operation. This process is called "samming."

Courtesy Kenya Information Office, Nairobi

FIGURE 66. - Modern staking machine as used in large tanneries.

Courtesy Marocchinerie e Scamoscerie Italiane, Turin



and stuffing is to prevent oxidation and so to avoid discoloration of vegetable tanned leather; to protect the grain against overdrying and cracking; to increase the water resistance; to ensure suppleness and softness; and to increase the elasticity — that is, the stretchability — of the leathers.

For fat liquoring and stuffing, many different oils can be used — for example, vegetable oils, such as groundnut, castor, sesame and cottonseed; animal oils, such as tallow, mutton fat, neats-foot oil; and marine oils, such as shark, cod and seal.

Oil used alone can only penetrate the leather with difficulty. It is customary, therefore, to use the oil as an emulsion, which is a mixture of oil suspended in the form of tiny droplets in another liquid, still in its insoluble state. Milk is a typical example of an emulsion; for the fat is suspended in the form of small insoluble particles. An emulsion of oil in water can be made with the help of emulsifying agents, such as soap or egg yolk.

Agitation helps to form a more constant emulsion. Thus the fat should always be run slowly into the soap solution, which is constantly stirred.

The correct amount of oil, together with the right emulsifying agent, determines the quality of the fat liquor. The aim is to make a fat liquor which remains as an emulsion for a long time. If the emulsion is badly prepared and insufficiently emulsified, it will separate again into its original components.

The oils most commonly used in large tanneries today are commercially available, and they are called sulphonated oils. These are oils which have been treated with sulphuric acid and have become water-miscible.

It is not intended in this chapter to give the formulae for all types of fat liquor which are used for the different types of leather, but every attempt should be made to use locally produced oils and to try them out as fat liquors. Nowadays, however, modern industry manufactures all kinds of fat liquors, stuffing materials and special oils for the tanner. For large tanneries the use of these products is well worth the expense.

As a rule, a fat liquor is prepared in the following way. First, soap is shredded into a little water. This is heated until it is completely dissolved, and then oil is stirred into the mass. When egg yolk is used instead of soap, the temperature should never exceed

38° C.; otherwise the yolk will coagulate, and the emulsion will not form.

The amount of fat liquor required is about 2 to 3 percent, calculated on the wet weight of the leather. The process of fat liquoring can take place either in a drum — in a float of warm water (40° C.), which is, as a rule, 300 percent of water on the weight of the skins — or in a wooden mortar, in which the leather is gently beaten with a pestle (Figure 67). If fat liquoring is done in a vessel, the leather is stirred either by hand or with a wooden stick until it has taken up most of the fat.

The average fat requirements of vegetable tanned leathers vary from 10 to 20 percent. For chrome leather they vary from 3 to 6 percent, but this depends entirely upon the type of leather which is needed. At first the fats are taken up only superficially by the leathers, and they are taken up more from the flesh than from the grain side. During further drying, however, the fatty substance is gradually absorbed and evenly spread throughout the leather.

When only a few skins are fat liquored, fair results can be achieved by rubbing in the fat on both sides and then by piling up the skins and by covering them with wet sacks, or a tarpaulin, for at least 24 hours. This method can be used advantageously instead of drumming or trampling in vats.

The following rules must be observed when preparing and using a fat liquor: soft or rain water is used; the leather is thoroughly washed in warm running water for 10 to 15 minutes before the fat liquor is added; after the leather has been taken out of the fat liquor, it is piled and covered with a wet sack for 24 hours before it is dried.

Fat liquoring is difficult, and even the experienced tanner may have occasional failures. Sometimes it happens that the emulsion is "broken" when the fat liquor comes into contact with the leather, and the oil settles in droplets on the leather. This indicates that the emulsion was not well prepared. The failure may also be due to the fact that different types of leather, according to the kind of tannin which has been used, vary in their ability to absorb and to retain fats. The choice of fats is difficult, and before using a new oil or a new emulsifying agent, it is best to test the new fat liquor on a piece of leather or on one skin before proceeding with a large batch.

Heavy leather requires more oil and fat than does light leather.



FIGURE 67. — *Fat liquoring, using an oil soap solution, is carried out in wooden mortar in some parts of the world. Leather is beaten gently with pestle.*



FIGURE 68. — *Operator rubbing an emulsion of fatty material and soap into heavy leather with piece of cloth.*

Courtesy Kenya Information Office, Nairobi

Too much oil is, of course, undesirable, for the leather than becomes too soft to be used as sole leather. Sole leather requires only one or two coats of oil. For preference, the coats are mixed with some sulphonated oil, which is applied on both the flesh and the grain side. The stuffing material which is used for heavy leather — that is, for belts, harness and so on — is called “dubbin”. As a rule, it is prepared by melting together one part of cod oil and two parts of tallow. Normally, it is first applied to the grain side. Then the leather is turned over and the same mixture is applied to the flesh. After drying, and after laying the goods away for 24 to 48 hours, both flesh and grain are finished by slicking. They are polished by brushing, which evens out the grease.

A “dubbin” for heavy leather, which is used for harness or belts, can also be made by warming a mixture of 1 kilogram of tallow, 1 kilogram of linseed oil and half a kilogram of neats-foot oil. Then 250 grams of soap are boiled in 10 liters of water. When the soap has been completely dissolved, the mixture is added to these ingredients.

If the stuffing material is too solid, it does not enter the leather; if it is too liquid, it runs off quickly. The leather is stuffed by rubbing the emulsion into both the grain and flesh sides with a cloth or with a wool sheepskin pad. The addition of sulphonated castor oil, or fish oil, improves the quality of the leather (Figure 68).

In large tanneries stuffing is done in a “hot drum.” This is a slowly revolving and heated drum. It has a hollow axle, through which hot fats — as a rule, a mixture of stearine, tallow and marine oils — are fed into the drum which contains the leather. The heat and the rubbing together produced by the revolutions of the drum encourage the penetration of the oils and fats.

The fat liquored or stuffed leather must be dried slowly in the shade. Generally, as the water evaporates, the fat is absorbed by the leather. Rapid drying in a bright light causes the fat to run off, or else it penetrates the leather only superficially.

X. LEATHER FINISHING MATERIALS

Many finishing materials are on the market, but the rural tanner is advised to use only those which he can obtain locally and prepare himself, such as milk, casein, blood, blood albumen, gelatine, glue and beeswax.

In this chapter finishing materials are reviewed. For the sake of simplicity they are divided into six main groups:

Proteins;

Waxes;

Gums and mucilages;

Resins;

Pigments; and

Miscellaneous, such as sulphonated oils, soaps, metal salts, plasticizers and solvents.

The first four groups are the most important for the rural tanner.

Proteins producing a gloss after glazing

MILK

Milk has been a leather finishing material since ancient times in Egypt. Half a liter of whole milk mixed with the same quantity of water makes a cheap and durable finish. Very good results are obtained by beating the white of one egg into the milk to increase the protein content.

For dark colored leather a good finish can be made by mixing 0.4 liter of milk with 0.3 liter of fresh, defibrinated ox blood and 2.3 liters of water.

CASEIN

In large tanneries, casein, one of the constituents of milk, is used instead of milk itself. A simple method of making casein is to leave the skimmed milk in a warm place to sour. To hasten fermentation, a "starter" — that is, a little old sour milk — can be added. After the milk has curdled, it is heated to 38°-48° C. to separate the whey. The whey is strained off through a sieve or a porous cloth, and this leaves the curd — the casein — which is washed in two or three changes of rain water — that is, soft water. The washed casein is placed in a triangular cloth bag, and as much water as possible is pressed out. Finally, the wet casein is broken up and spread evenly over a mosquito gauze and exposed to the sun for drying. It is turned repeatedly until it is completely dry. A stock of dried casein can be stored in tightly closed jars, and it will keep indefinitely.

Casein is only slightly water soluble, but it is easily dissolved in the presence of borax. A typical finish can be made from 2 kilograms of casein, 7 kilograms of water and 1 kilogram of borax. The casein must soak for about half a day in cold water. The borax is then dissolved in a little water and added. The whole is heated to about 74° C. for 15 minutes, until a transparent solution is obtained.

This stock solution is made up with water as required at the rate of one part of stock solution to ten parts of water.

Ammonia can be used instead of borax. In that case, 1 kilogram of casein is soaked in 10 kilograms of water for several hours, and then 0.25 kilogram of ammonia and 10 liters of water are added.

GELATINE

Another good finishing material is glue or gelatine, which is applied on the grain side as well as on the flesh side. Glue mixed with starch or whiting is often applied on the flesh side of sole leather to improve the appearance, while a solution of gelatine in water gives a very good finish on the grain side. Gelatine should be prepared in the following way:

1. Collect all fleshing, trimmings and any limed and unhaired hides or skins which have been rejected.
2. Wash in several changes of soft water until all traces of visible lime are removed.

3. Put in a bran; drench overnight, or wash in boric acid solution. Squeeze out by hand as much water as possible.
4. Put in a pot without adding water and place on the edge of a stove, so that the mass will be heated but not brought to the boil.
5. After four hours some "soup" will be seen, and it should be poured off. This is the best and the strongest gelatine bearing liquor, and it can be applied immediately.

A further supply of gelatine soup can be obtained by heating for four hours at the same temperature. This second cooking gives good quality gelatine, but repeated cooking yields only glue. To the second, third and fourth cooking a small amount of water must be added to avoid burning the bottom layer of stock. Fleshings and trimmings, however, produce a far greater yield of gelatine if they receive prolonged liming beforehand.

It is not practical to prepare the dried glue or gelatine at home, and thus the process of drying is omitted. Fresh glue and gelatine should always be used. Where a formula requires the solid material, approximately ten times as much of the liquid is required.

A gelatine finish is prepared from dry gelatine in this way: one part of gelatine is put into a jar, covered with eight parts of water and left for several hours until it absorbs most of the water and swells. This gelatine is put into water in a pan and warmed, but not boiled, until a completely transparent solution is obtained.

Another good flesh side finish for sole leather may be made from 1 kilogram of glue, 1 kilogram of flour, 120 grams of soap and 240 grams of sugar of lead (lead acetate) dissolved in 20 liters of water.

If liquid glue is employed, 10 kilograms of glue soup are used to replace the 1 kilogram of dry glue.

BLOOD

Blood may be used as finishing material in two forms: (a) black blood; or (b) blood albumen.

Black blood is used for finishing dark colored leather. Its preparation is extremely simple: collect in a clean, dry vessel — preferably a glass jar — blood from a freshly killed animal, but avoid impurities,

such as stomach contents and hair; beat the blood with a wooden spoon or glass rod until a thick clot collects round the rod; this is fibrin, which should be removed. Cover the bottom of a shallow pan with the residue to a depth of about half a centimeter and expose to the sun; stir from time to time and leave the blood until thick, black, dried flakes are obtained; keep dry in a closed jar.

Blood albumen is used for light colored leather only, and it is made in this way: put the collected defibrinated blood in a cool place and leave for 24 hours; the next day the blood will have two layers, one dark brown and the second reddish-yellow, completely transparent; pour the transparent part into a shallow vessel and dry.

Defibrinated blood and blood albumen may be used fresh without drying, but since blood is not always available, it is useful to have a stock of both.

EGG WHITE OR EGG ALBUMEN

The white of fresh eggs, beaten with twice as much water and strained through mosquito gauze wire, can be applied fresh as a leather finish. Fresh eggs, however, are not always available and, as the whites of eggs may remain when yolks are used for fat liquoring, it is helpful to know how to prepare egg albumen.

To obtain egg albumen, separate the yolk from the white; to one part of egg white add two to three parts of water; beat with a fork until a froth is formed; pass through a mosquito gauze wire to remove all large particles; put in shallow pans to evaporate at a temperature not exceeding 40° C. and stir as described under the drying of blood. If no thermometer is available, this temperature is just above blood heat — that is, a little warmer than lukewarm.

The dried egg albumen looks like whitish scales. To make a finish, one part of this dried powder is put into eight parts of water, well shaken and put aside. After several hours the albumen will be completely dissolved. Do not try to heat or boil blood albumen or egg albumen; for the heat will coagulate it and make it quite useless.

All these products decompose rapidly when they are wet. For this reason, no more than is needed for one day should be prepared.

STOCK SOLUTION

The decomposition of these protein solutions is caused by bacterial action which makes them thin, smelly and useless as finishes. It may be delayed by chemical preservatives. One percent by weight of beta naphthol will preserve the solutions for a long time. Even if preservatives are used, however, finishing material should not be prepared in large quantities, but only in quantities sufficient for one week.

APPLICATION

The application of finishing materials to the leather is a very simple operation. Failures should not occur if the finishing material is fresh, if there is a proper concentration, and if the following rules are observed:

The leather must be perfectly dry and flat before the finish is applied. The finish should be applied with a sponge, brush or cotton wool and evenly distributed; a "flit" pump is also an excellent means of applying finishing materials. After it has been applied, the finish must be allowed to dry before the glazing begins. The surface on which the glazing is to take place must be hard and completely smooth.

GLAZING

In large tanneries, special power-operated glazing machines are used. They consist of a glass cylinder fixed at the end of a wooden arm, which moves backwards and forwards. The glass cylinder is usually 13 centimeters long by 5 centimeters in diameter. The operator puts the leather on the bed of the machine and moves it in such a way that all the parts get the same gloss. Glazing not only adds gloss but increases the water-resistant properties; for the heat created by the friction of the glass over the leather coagulates the protein present in the finish (Figure 69).

The small tanner can obtain good results by using as a glazing cylinder a jar or bottle, provided it is round and free from inscrip-

tions, patterns or irregularities. The bottle or jar should be held firmly in the hands, and moved backwards and forwards over the leather (Figure 70). Care must be taken, however, not to turn it in the hands; for sweat would wet the glass and thus prevent the gloss developing. A heavy plate glass slicker would also be a good substitute.

Waxes producing a gloss after brushing

Many waxes are used in finishing operations — for example, montana, carnauba and beeswax.

The use of beeswax only will be described here, because it is easily obtained and cheap. A simple beeswax finish may be made as follows: one part wax, five parts soap, six parts turpentine and six parts water.

The soap is first dissolved in boiling water, and the wax is heated in turpentine until it is completely melted. The two liquids are then put together and mixed until a uniform mass is formed.

A wax emulsion may be prepared from 1 kilogram of soap and 0.5 kilogram of borax. These are boiled, with continual stirring, in the least possible amount of water until the soap has completely melted. To this, 3 kilograms of hot melted beeswax are added, and the mixture is stirred. Then hot water is added, half a liter or so at a time, until the whole mass has absorbed some 20 liters of water.

Waxed leather cannot be glazed, for glazing raises the temperature above the melting point of wax, but a gloss can be produced by brushing.

Gums and mucilages

Of all the gums, perhaps, gum arabic is the most used for leather finishes. Even so, its popularity is limited, for the dried film it produces on the leather surface lacks the flexibility which is normally desired. This gum exudes from the stems and branches of the acacia trees (*Acacia senegal*). It is known as *hashab* gum in the Sudan; and from this source most of the tannery requirements are met.



FIGURE 69. - *Glazing leather on power-operated glazing machine.*

Courtesy Kenya Information Office, Nairobi

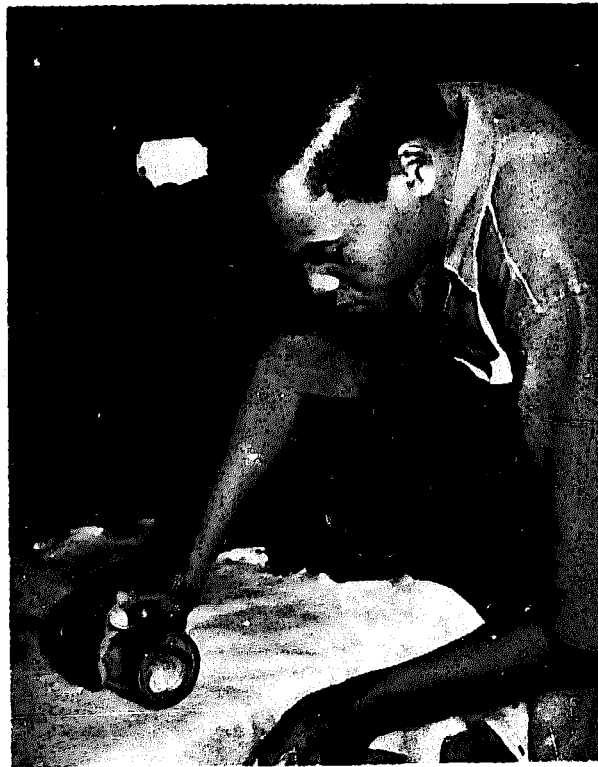

FIGURE 70. - *Glazing by hand, using a jar which is moved backward and forward over the leather.*

Courtesy Kenya Information Office, Nairobi

The hard yellow, translucent "tears" are soluble in water, but solutions putrefy easily. The "tears," however, can be stored for long periods.

IRISH MOSS OR CARRAGHEEN

This is the dried seaweed found along the coasts of Ireland and New England, which can be made into a solution by first washing in cold water to remove the salt and then boiling for about two hours. The solution will set to a jelly, if it contains more than 10 grams per liter. Some other kinds of seaweeds are also suitable, such as Iceland moss and agar-agar.

LINSEED MUCILAGE

This material can be prepared by extracting ripe flaxseed in about 40 times its weight of boiling water for approximately two hours and by straining while it is hot. The mucilage is contained only in the shell of the seed, and, to avoid extracting the oil as well, the operation must not be prolonged. This mucilage is often added to other finishes to reduce the brittleness which is experienced with gums.

Resins

Shellac or lac is the only true resin universally used for leather finishes. It is found as a thick crust on small branches of several species of Indian trees, and it is actually a secretion of the lac insect (*Coccus lacca*).

It is collected and macerated with water to extract a brilliant red dye, which is called lac dye. It is afterwards refined by melting and by straining and it is allowed to cool and harden either in moulds or in thin flakes.

Shellac is soluble in alcohol (methylated spirit) or mild alkaline solutions, such as ammonia or borax. When it is used as a leather finish it imparts resistance to washing and wetting. It might well be used to finish dyed leather which is not fast to wet rubbing and perspiration, such as leather for pouffes.

Pigments

These finishing materials are virtually colorless. By the addition of certain pigments, such as carbon black, white lead or zinc oxide, the finish can be converted into a kind of paint, which is called a pigment finish. For such a finish skill is needed as well as special equipment during the preparation, grinding and mixing. It is not advisable for the beginner to attempt it. Later, after having acquired the art of simple finishing, he can try to blend pigment finishes.

In these finishes, the wax emulsion and the casein solution are used either together or separately. A typical formula, when wax and casein are used, is: five parts casein solution, twelve parts wax emulsion, one part sulphonated oil and six parts pigment — for example, zinc oxide or carbon black.

The pigment finish is applied with a pad or a brush. Circular and even strokes are used, so that the thickness of the finish is uniform.

When a pigment finish is completely dry, it should be glazed. If a high luster is required, the surface can be treated with a protein — for example, blood albumen or milk — and then glazed again.

Miscellaneous materials

To enumerate all the materials which are at the disposal of the more advanced tanner is beyond the scope of this paper. A few words may be useful, however, on the advantages of sulphonated oils as a dispersing agent for pigments; on sodium and potassium soaps as emulsifying agents for waxes; on glycerine for keeping rather hard brittle finishes more pliable, as well as on plasticizers, such as castor oil, for use in lacquers; and on linseed oil, which is another excellent plasticizer used in the finish for patent leather.

XI. ALUM TANNING

Where white leather is required, alum tanning should be employed. Although this is not entirely resistant to moisture, the process of alum tanning is widely used where soft, white and pliable leather is to be made by simple methods. The use of alum is known from very ancient times; it may have been introduced in Europe by the Arabs who, for centuries, had employed it as a tanning material.

Alum tanning is suitable for both unhaired skins and fur skins — for example, rabbit, buck or leopard. It may also be used for reptile skins, such as lizards or snake.

The skin must be perfectly soaked in cold water with a little salt to retard bacterial action, and great care must be taken to remove all the hypodermis — especially of fur skins — for flesh and adipose tissues prevent the penetration of the alum salt.

For goods tanned without hair, scudding after depilation must also be perfect; for any remaining hair or follicles will show on the finished white leather.

There are three methods of using alum for tanning: alum can be applied in the form of a solution; in thin paste; or in thick paste.

Whatever method of treating the skins is used, it is important, first of all, to examine their condition of acidity or alkalinity. If they contain lime or alkali, this will make the alum very astringent, and it will give a hard, firm and tinny leather. If, on the other hand, they are too acid, the tannage will be poorly fixed and the leather will be very thin. The right condition is about pH 5.0, which is obtained by drenching free from lime; it is a very slightly acid condition.

Alum solution

This is made by dissolving 10 kilograms of potash alum and 3 kilograms of salt in 100 liters of water. The skins are soaked in this solution for some three days, and there is occasional stirring. After this, they are taken out, dried completely, kept for about three weeks to mature and then placed in moist sawdust before they are staked.

Alum in solution produces a leather which is not very soft. To obtain softer leather, drumming or churning in a thin paste is recommended.

Thin alum paste

Dissolve 3.5 kilograms of potash alum and 1 kilogram of common salt in enough water to make a thin paste. A little soda is added until a slight cloudiness appears. Then approximately 1 kilogram of egg yolk and 2 kilograms of flour are added. Add 110 liters of water and mix thoroughly.

The skins are placed in a drum or churn with this paste and revolved for approximately four hours. Afterwards, some more paste is added. This amount of paste is sufficient to tan 45 kilograms of wet goods. When the second quantity of paste is added, some oil, such as groundnut oil, should also be added. The tanning takes a whole day. The skins should then be left overnight and taken out on the following day.

Thick alum paste

When a drum is not available and the amount of skins to be tanned is not large, a satisfactory alternative method is to use a thick alum paste which is made in this way: dissolve 1.5 kilograms of potash alum and 0.5 kilogram of common salt in a little water, and add 12 egg yolks and 2.5 kilograms of flour. Add water to this mixture to bring the texture to that of thin porridge.

The paste is applied by laying the skins flat on a table and by rubbing the paste evenly into the flesh, while leaving a layer of about half a centimeter on the surface. To retard drying out, the skins are folded inwards. They are rolled and then piled in a cool dark

place, where they are covered with wet gunny and weighed down with a stone. After about five days, the damp or dried paste is shaken off. This process may need to be repeated, according to the thickness of the skins. When a reapplication is necessary, the skins are resoaked in water until they are soft. The paste is applied in the same way as before.

There are many recipes for making alum paste. Most tanners have their own which they find suited to different kinds of leather. Here is a popular recipe.

Dissolve 1.1 kilograms of potash alum and 0.5 kilogram of common salt in a little water. Mix separately 1.8 kilograms of flour, 0.5 kilogram of French chalk or kaolin with 0.7 kilogram of egg yolk and 58 grams of olive oil; and add 5.7 liters of water.

Too much salt always produces moist leather, while softness, fullness and velvety texture can be achieved by adding egg yolk.

The finishing of alum tanned leather requires skill and patience. It cannot be hurried; for the leather should "age" for some three weeks before finishing. Before staking, it is wise to put the leather in moist sawdust overnight; for this simplifies the operation. The wood from which the sawdust is derived, however, must be white and free from tannins. Finishing with pumice stone or sandpaper gives a velvet texture. Should there be fat stains, these can be removed by dusting the area with French chalk, rubbing with bran, or dabbing with petrol on a clean rag or cottonwool.

Alum tanned leather, as has already been mentioned, is not waterresistant. It is thus unsuitable for shoes.

XII. OIL TANNING

Oil tanning is one of the oldest forms of tanning. Our ancestors used stones to rub fatty substances, such as brains, bone marrow, ghee, butter or milk, into hides and skins to obtain a material which resembled leather. The process was simple. The hides or skins were treated with cattle dung, or they were merely bundled and left until a superficial putrefaction had started. After the hair had been loosened, it was removed by rubbing with a sharp instrument. Brain or marrow was then applied to the flesh side and the skins were covered, so that little air could find access. After a week, they were spread out, stretched, pulled and kneaded to soften them. The flesh side was then cleaned of meat with a sharp instrument and rubbed smooth with lime or pumice stone.

Today the process of oil tanning is basically similar, and it still involves kneading, stretching and trampling. Oil tanning is, therefore, a combination of chemical and mechanical processes. Correctly prepared oil tanned leather is durable and washable, and it is considered very healthy to wear. Oil tanned leather with the proper characteristics can be obtained only by using marine oils, such as cod, whale, shark or seal; of non-marine oils, rape oil is claimed to be the best.

Making reims

A typical example of rough oil tanning is the preparation of leather ropes called reims, which are used for ox harness in South Africa. Apart from harness, they may be used to secure animals or as springs for beds, seats and for many other purposes.

Reims are made by a combination of mechanical treatment

(twisting) and chemical treatment (rubbing in oils or fat). Although the making of reims is not regarded as true tanning, it is described here because it is useful for rural tanners, who can sell their produce to farmers.

Hides from suitable animals should be carefully selected — in particular, hides from young oxen or steers. It is possible to make reims with the hair on, but some prefer to remove the hair by one of various depilating methods.

As full liming is not necessary, the hides should only be kept in lime until the hair can be scraped off easily. Alternative methods of unhairing are immersing the hide in water with wood ashes, or leaving the hide in bran for a few days; either method loosens the follicles, and then the hair can be scraped off easily.

The unhaired hide is now cut into 2.5 to 3.5 centimeter wide strips. If very long reims are needed, they can be made by cutting around the hide from outside towards the center. In this way, one reim only is made from the whole hide. The reims are now hung over a branch of a tree, so that the two ends are hanging down. An ox cart wheel, or a heavy stone, or a piece of iron rail is attached to each end. After they have dried a little, the reims are ready for oiling. Good results are obtained by rubbing in marine oils. Equal parts of marine oils and animal oils — for instance, cod or whale with melted tallow or mutton fat — can also be recommended. Penetration of the oils is made easier by winding and unwinding for half an hour. This process of twisting by hand is repeated at least three times daily. The next day the reims can be moistened, and the twisting and untwisting are repeated. After four to five days of this treatment, the oil tannage should be complete.

“Raw hide” leather

This term is used to describe hides and skins which have received a type of fat tanning by working in fatty substances. The mechanical action softens the hide, while the fat renders it waterproof and resistant to decay.

Even today, the following primitive method is used in certain rural areas: a paste is made which contains seven parts of flour, seven parts of beef tallow, two parts of mutton fat and one part

of salt. By adding a little warm water, all the ingredients are mixed together until a paste of uniform consistency is obtained. This is ready for use and it is applied on an unhaired hide or skin.

In certain parts of the world, raw hides are prepared in the following way: properly limed, unhaired and fleshed hides are rubbed, when still wet, with any available oil or fat, or even a combination of both — for instance, 1 kilogram of groundnut oil with 1 kilogram of tallow. They are heated together until a uniform mixture is obtained. This is rubbed into the flesh side of the hide, which is then hung over a wire in a dark, warm room. Before it is completely dry, it is kneaded, worked over and trampled and then put in water for a short period. The wet skins or hides are again oiled and returned to the dark room to dry. The process is repeated several times, according to the thickness of the hides. Oils and fats should be applied only to damp or wet hides; for during the process of evaporation, the fat replaces the water. The flesh side is then smoothed by rubbing with pieces of pumice stone.

Oil tanned leather

This simple method of oil tanning suitable for rural tanneries is recommended.

Properly delimed skins are rubbed with one of the marine oils — for example, cod, shark, whale or seal. The skins are then put into a wooden vat and trampled for three hours until they have a soapy, slippery appearance. Afterwards they are taken out, piled one on top of the other and tightly covered with a tarpaulin. When the pile is opened next day, it will be found that heat has been generated and that a definite odor has been produced by the skins. They are again put into the vat, sprinkled with oil and trampled for another three hours. A second dressing of a mixture of 1 kilogram of cod liver oil and 3 kilograms of soap which is dissolved by heating in 10 liters of water may also be applied.

The skins are now hung to dry in a very small and very warm dark room. After they have completely dried out, they are soaked in warm water, and all the excess oil is squeezed out. The skins are stretched in all directions, kneaded and worked over again until

they are extremely soft and pliable. They are again washed in warm water and hung in the sun to give them a light color. After the skins are dry, they are stacked and finished in the usual manner.

Chamois tanning of sheepskins

Certain oils have been known and used since prehistoric times for their tanning action. Centuries ago, the skins of the Alpine chamois, tanned with oil, were in great demand for clothing leathers.

As the true chamois became scarcer, tanners learned to prepare sheepskins for the leather which is known today as *chamois*; and the process of oil tanning sheepskins is known as *chamoising*.

This tanning method produces very supple, stretchable and soft leather, but it involves much time and labor. Special care has to be taken and it is a good practice to use a ball mill or a machine called "crank," "faller stocks," or "kickers."

Chamois tanning is confined to sheepskin fleashes; and the grains after splitting are tanned and dyed as skivers for fancy leathers.

The "faller stocks" machine (Figure 71) consists of two vertical arms, which swing past each other when the machine is running. Attached to these arms are two cast iron feet, which are made in the shape of steps and which pound and work the leather. The pummeling, or stocking, is occasionally stopped, and then the skins are spread out to cool. They are oiled again and returned to the faller stocks.

The skins receive several treatments with cod liver oil, or with seal, whale, shark or similar oils. The highest quality of chamois, however, is obtained with cod liver oil. Between the operations, the skins are piled up in heaps and covered with canvas. Chemical reactions develop much heat in the heap and it is necessary to turn the skins over occasionally to prevent damage from overheating. The duration of this tanning process is determined by the properties which are desired in the leather.

During piling, the color of the skins is gradually changed into yellow, and this indicates that tannage has set in. Temperature inside the pile, however, should never exceed 40° C.

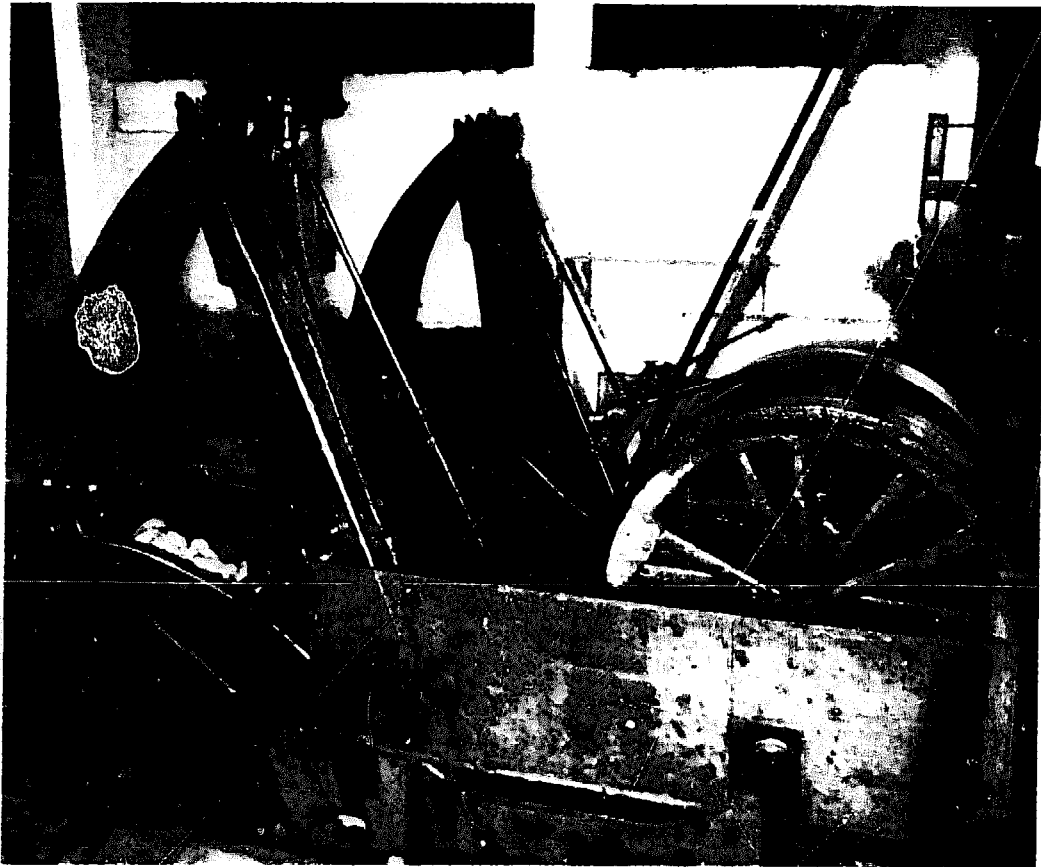

FIGURE 71. - Crank or faller stock machine as used in oil tanning.

Courtesy Marocchinerie e Seamosceerie Italiane, Turin

In hot weather, the piling of oil-treated skins is not practiced. Instead, the skins, after treatment with oil, are immediately hung up for drying in a warm humid room, where the tanning action of the oils proceeds. When the tannage is judged complete, the leather should then be drummed in water at about 40° to 43° C., to which soda ash has been added. For example, for one dozen sheepskins, 0.5 kilogram of soda ash is dissolved in water and added to the drums. By this process the surplus oil is emulsified and removed.

The bulk of uncombined oil thus recovered is sold to tanners as a fat-liquoring material under the name of *moellon*. At this stage, the skins are judged for their color, and if they are considered to be too dark, bleaching is done with a solution of 120 grams of potassium permanganate and 20 grams of sulphuric acid (specific gravity 1.84) in 100 liters of water. This process can be advantageously carried

out in a drum. The color of the skins now becomes brown. By a subsequent treatment with sodium bisulphite and one to two percent hydrochloric acid (specific gravity 1.1) in 100 liters of water, the color of the skin gradually changes into white. The best bleach is produced by exposure to sunlight. Bleaching, however, is not essential, unless the skins are to be dyed in pale shades.

An extra amount of cod liver oil is essential. For a dozen skins, for example, 4.5 kilograms of oil are required. Sometimes on 100 parts of finished chamois leather, 100 to 150 parts of oil are consumed.

XIII. TANNING OF FUR, WOOL OR HAIR SKINS

From earliest times, animal furs — among them the furs of bear, fox, mongoose, mole, monkey, lynx, leopard, rabbit, otter, sable, squirrel and antelope — have been used for clothing. Over the centuries, the art of tanning has been gradually developed to the present high standard, but its basic principles have only slightly changed. Several methods are used. Some are described in this chapter.

Correct preparation of the fur skins

It is most important that the fur should reach the tannery without any damage to the hair; for obviously the hair is the most valuable part. Fur skins require greater attention than others; for almost any damage leads to a loss of hair and to bare patches. The flaying knife should be curved with a blunt tip.

Flaying should be started as soon as possible, preferably while the animal is still warm. Casing is the best method, for it does the least damage to the fur. For preference, it is done by hand pulling, and the knife is used only to cut subcutaneous muscles.¹ The greatest care must be taken while flaying around the nostrils, ears and eyes, for these places are easily damaged. With many furs, however, the head is not flayed at all, and the skin is removed only as far as the neck.

Preservation

The finest results are obtained when the furs reach the tannery completely fresh and within four hours of flaying; but, as a rule, these conditions are impossible. The alternative is to use some

¹ See *Flaying and Curing of Hides and Skins as a Rural Industry*, FAO Agricultural Development Paper No. 49, p. 30.

temporary preservatives, such as immersing the skins in a saturated salt solution for a few days.

For longer periods, however, wet salting can be used, and this requires skill.² First, the skins should be thoroughly washed to remove any blood. Then, after draining and fleshing, they should be spread on a flat table or on the ground, and fresh medium-grain salt should be rubbed in evenly. Afterwards, the bellies are folded over, so that they touch each other. The skin should then be rolled — with the hair out — from head to tail and the bundle secured with a rope. A skin preserved in this manner will remain fresh, according to the weather, for about ten days. This method is particularly suitable for hunters who are able to deliver the furs to a tannery within this period.

When the skins have to be kept for a longer period, they must be either resalted or dried. This is done in the following manner. The salt which has been left over is shaken off, and all the wrinkles and infolds are carefully stretched out. New fine salt is spread evenly, and it is gently rubbed over the whole surface. An even layer of not more than 0.5 centimeter of salt is left, and the belly part is closed together. The skins are now rolled from the head towards the tail into a round bundle and tied with a string.

Further preservation for periods of longer than five to seven days can be achieved by drying the previously salted skins. The salt is beaten or shaken off, and the skin is merely dried, flesh side out, over a wire in the shade. The fur must be suspended without wrinkles; otherwise putrefaction may occur. Here again, by leaving the flesh side out, the hairs are protected against the bleaching rays of the sun.

Certain types of fur skins are dried on a skeleton frame by inserting a U-shaped piece of wire. Drying must be in the shade, and it is always done with the flesh side out. Drying on a hoop can be carried out easily by bending a green branch to the desired form. Alternately, the skins may be dried on a board by nailing them, while allowing a space of at least 1 centimeter between the board and the skins.

Fur skins are susceptible to heavy damage by insects, but a certain degree of protection can be obtained by the use of dry pyrethrum flowers, naphthalene or chillies, finely ground and spread

² See *Flaying and Curing of Hides and Skins*, p. 70.

over both surfaces. Evenly dusted modern insecticides which contain gammexane or DDT will provide complete protection for up to six months.

Tanning

The aim of tanning is to obtain an attractive and lustrous fur, and the damage which results in bare patches must be avoided. The tanning of fur skins is similar to the tanning of other skins, except that the epidermis, which includes the hair, is not removed; and liming is not practiced because it leads to the destruction of the epidermis.

Soaking, therefore, should be carried out with the utmost care, and the operation is completed as soon as possible to prevent hair slip. Only cold water is used. The soaking period for air-dried fur skins should be longer than that for dry-salted or wet-salted skins. To facilitate the soaking process, 3 to 5 percent salt is added to the water, which should be changed several times. Large skins can be trampled by foot, taken out and worked with a blunt knife over a beam until the hard meat can be removed. Small fur skins can be rubbed by hand until they are completely soft.

For small fur skins, the salt solution is also applied only on the flesh side to prevent any possible damage to the hairs.

Wool skins which, such as lamb, contain fat or grease must first have the fat removed by fleshing. This is followed by washing in several changes of warm water, to which washing soda is added. Apart from this defatting procedure, however, good results are obtained only when the cured skins are brought back to a condition almost similar to their condition immediately after their flaying before curing.

Chrome tanning of fur skins

The preparation of fur skins which are resistant to all kinds of influence is best done through chrome tanning. In the past, chrome tanning was made unpopular through some mistaken idea that it was difficult to produce soft and supple fur skins. Chrome tanning,

it was also found, made the bleaching of the hairs difficult. After bleaching, it often happened that the entire lot of chrome furs was destroyed. These disadvantages and difficulties, however, have all been overcome. At the present time, the best quality fur skin can be produced by this method, even though an inexperienced tanner encounters preliminary difficulties.

Chrome tanning, it must be recognized, is an irreversible process. In contrast to alum tanning, however, chrome tanned fur skins are full, durable, and resistant to moisture and heat. The properties of chrome tanned fur skins are also especially advantageous for the dyeing process. It is now possible to dye all kinds of fur skins by first treating them with chrome.

As a rule, those chrome tanning materials which are applied for ordinary leather tanning — that is chrome alum and other commercial chrome salts — can be used.

Special care, however, is needed to prevent an overtanning of the hairs. The so-called two-bath chrome tanning method should not be followed, because it produces an undesirable tanning of the hairs.

The following chrome tanning methods are recommended:

- (a) the application of the chrome liquor on the flesh side of the skins only; and
- (b) the immersion in chrome liquor in a vat or paddle.

The application of chrome liquor on the flesh side is only practiced when the number of skins to be treated is small. The concentration of the chrome liquor is then 30 to 40 grams of chrome salts (with 25 to 30 percent chromoxide) and 60 to 100 grams of common salt for each 1 liter of water.

The concentration of the liquor to be used in a vat or a paddle should be 4 to 6 grams of chrome salt and 30 to 40 grams of common salt for each 1 liter of water; and the ratio of skin to liquor is equal to 1 to 10 or 1 to 20. Paddling should be continuous.

Pickling before chrome tanning is not required, because the fur skins have not undergone any alkali treatment.

An initial tanning with aluminum salts, by which process the skins are brought to a slight acid condition, is beneficial. Chrome salts, which are expensive, can then also be saved.

Initial alum tanning should always be followed by a reduction of the moisture content of the skins; for this facilitates the thinning out of the flesh side.

The bleaching of the hairs with hydrogen peroxide can also be carried out in a more efficient way without damaging the skins. This peroxide bleach should be done before the chrome tanning; otherwise the leather might be completely destroyed.

For initial alum tanning a concentration of 30 grams alum and 50 grams common salt is used per 1 liter of water.

For chrome retanning, chrome alum is being used, and about 15 percent of the shaved initial alum tanned weight is recommended.

For tanneries with drum tanning facilities, the following procedure is recommended :

- (a) to 100 percent water, add 5 percent common salt and turn for 15 minutes;
- (b) add 2 percent chrome alum and 7.95 percent sodium carbonate on chrome alum weight; turn for an hour;
- (c) add 3 percent chrome alum and 10.6 percent sodium carbonate on chrome alum weight; turn for one hour;
- (d) add 5 percent chrome alum and 15.9 percent sodium carbonate on chrome alum weight; turn for one hour;
- (e) add 5 percent chrome alum and 15.9 percent sodium carbonate on chrome alum weight; turn for two hours.

(In drumming wool skins, the drum should revolve slowly — say, about twice each minute — and thus avoid any felting of the wool.)

Finally, add 0.4 to 0.8 percent sodium carbonate on the initial tanned weight, dissolve sodium carbonate in 10 to 20 times water, and turn for a further three hours, or until tanned through.

Tanning time differs. Light hides or skins are tanned in about eight hours, while heavy hides take 12 to 24 hours.

On the second day, if a longer tanning time is needed (12 to 24 hours), more sodium carbonate is added.

The chrome tanned fur skins should be horsed up overnight for about 12 hours to ensure a maximum fixation of the chromium. The skins are then washed and neutralized. Washing removes most

of the salts and some of the acid present in the leather. The removal of the salts helps to prevent the formation of a salt spew later on, and the removal of free acid mechanically held by the fur and leather ensures that the neutralizing agent is not wasted.

Neutralization of fur skins is carried out in a drum, and the leather to water ratio should be 1 to 20. For neutralization, 10 to 30 grams sodium bicarbonate per liter of water are sufficient, and the drumming is for about half to one hour. Subsequently, the fur skins are thoroughly washed in running water for 30 minutes.

Tanning of hair skins with basic aluminium sulphate

The Central Leather Research Institute in Madras recommends the following process.

Skins which are received in a dry condition are soaked overnight in a 6 percent solution of common salt, to which 0.1 percent carbolic acid, or 1 percent boric acid, on the volume of water is added. The skins are left in the soaking bath overnight. Next day they are rough fleshed, if this is necessary, and again soaked in a fresh soaking bath prepared as before. They are left in the bath overnight until the skins acquire the desired softness. They are then taken out, and the water is allowed to drip off them.

Next they are pickled with 100 percent water, 10 percent common salt and 1 percent sulphuric acid; and these percentages are based on the weight of the soaked skins. They are left in this solution for one or two days. During this time they are hauled up, well drained and put back. The pH of the pickled pelt is about 3.5 to 3.7.

The skins are now piled and tanned in a liquor, which contains 15 percent basic aluminium sulphate, and this is calculated on the pickled weight.³ Tanning takes from two to three days. It is completed by the addition of soda ash, or hypo, in the quantities needed to raise the pH of the tanning bath. The initial pH of the bath is 3.5 to 3.8, and this is raised to 4.5 towards the end of the tanning process. The addition of soda, or hypo, makes the tanning liquor more basic; that is, more powerful for tanning. To ensure

³ For the preparation of this solution, see later section of this chapter on "Pickling."

a complete tanning, the skins are left in this soda bath for another one or two days.

The completely tanned skins are washed with water to remove the adhering tan liquor from them. The washed skins are horsed up, or piled, for "samming" — in order to remove an excess of water by a slight drying.

The "sammed" skins are fatliquored at a temperature of 45° C. for one hour with a fat liquor of this composition — sulphonated neats foot oil 1.5 percent; neats foot oil 1.5 percent; cod oil 1 percent; castor oil 2 percent and soap flakes 1 percent — or else with any other suitable fat liquor.

The percentages are on the weight of the "sammed" skins. The fat liquor is adjusted to a quantity which does not make the finished skins too greasy.

In the finishing operation the fatliquored skins are "sammed" by drying them in the shade. The dried skins are finally staked to make them nice and soft to the feel.

Basic aluminium sulphate is usually prepared the previous day in the following way: dissolve, in a tub, 31.8 kilograms of aluminium sulphate and 2.3 kilograms of sodium citrate in 68 liters of water. Dissolve separately, in another tub, 7.9 kilograms of soda ash in 23 liters of water. The soda ash solution is added in two or three instalments in the course of an hour and with a good stirring. The solution is left to age overnight. The clear solution has a pH of 3.4.

Fur skin tanning with vegetable and synthetic tanning materials

Vegetable fur skin tanning, if practiced alone, will not produce the same quality leather as that obtained with other tanning materials. Lack of softness, stretchability and suppleness are the main reasons why this tanning method is seldom practiced in fur skin tanning. During vegetable tanning, moreover, the hairs of the skin become more or less colored, while it is also a disadvantage that the dyeing of vegetable tanned fur skins can be carried out in dye solutions only at low temperatures.

The dyeing of chrome tanned skins, however, can be done in a more efficient way; for they can be dyed at much higher temperatures than can vegetable tanned fur skins.

Very good results are also obtained by using a combination of vegetable and synthetic tanning materials, but when a bright and white fur skin is required, synthetic tanning materials alone are preferred. This skin should be first pickled in a solution of sulphuric acid and common salt, followed by draining and centrifugation, and finally it should be tanned in a synthetic tanning solution of 30° to 40° Bkr. Pickling by immersion, however, is recommended only if the fur or hairs are unharmed.

PICKLING

Although it is customary to pickle fur skins, certain difficulties must be overcome. Some fur skins are discolored when they come into touch with acids. When, therefore, pickling is applied, care is needed to avoid wetting the fur side.

Pickling of fur skins differs from that of unhaired skins, for they are not immersed in liquor. Instead, they are swabbed with it while they are stretched in a frame or spread on a table. The concentration of the pickle is 3.6 kilograms of common salt and 0.3 kilogram of sulphuric acid (specific gravity 1.84) to 40 liters of water.

Pickling of fur skins has also been done successfully by using a mixture of one part sodium bisulphate and four parts of common salt; and the dry pickle is rubbed into the wet skin.

TANNING

Synthetic tanning materials are used in the following ways:

- (a) as an initial tanning alone — that is, before the tanning with vegetable material; or
- (b) blended with vegetable tanning materials in the tanning process; or
- (c) alone or blended with vegetable materials as a retanning.

To pickled stock destined for drum tanning, the initial tanning is normally applied in the drum. About 4 to 5 percent of a suitable synthetic tanning material, based on the drained and pickled weight of the furs, is used.

The undiluted synthetic tanning material is added directly to the stock in the drum, and 30 minutes of drumming are sufficient for the complete take-up of the tannins. The furs are washed in water to remove excess salt and acid.

The after-tanning in drum, paddle, or pit proceeds rapidly, and a strong vegetable extract solution of 30° to 40° Bkr. can be used for very heavy skins. This type of tanning has proved successful on greasy stocks or on stock hard to penetrate.

Finally, the tanned skins are thoroughly washed, fat liquored and finished in the usual way.

Fat liquoring

If oil is not introduced during tanning nor incorporated in the alum paste, fat liquoring of the fur skins is necessary. The fat liquoring process also follows chrome tanning, neutralizing, washing and draining. The object is to restore the natural fats which were lost during the tanning, and thus to regain suppleness and softness. The fatty matters most suitable for this purpose are generally in liquid form — that is, fish oils, mineral oils and vegetable oils, such as are obtained from rape seed. Glycerine is also used, and it is mixed with oils to facilitate the penetration of the fat liquor. Undiluted egg yolk can also be applied by rubbing in evenly on the flesh side.

To a large extent sulphonated oils are now replacing the conventional oils, for their use results in a better penetration and in a more uniform distribution of the fat. Their emulsions are more stable in hard water.

Fat liquoring is usually applied to the flesh side, and special care should be taken not to contaminate the hairs. After fat liquoring, the fur skins are piled, flesh on flesh, folded together along the backbone line and left in this condition for a couple of hours. They are then hung for drying over poles in well ventilated rooms, where the temperature should not exceed 30° C. The skins should not be allowed to dry out completely, for they should retain enough moisture to facilitate the subsequent stretching, cleaning, degreasing and softening processes. It is a good practice during drying to stretch the skins in all directions.

In the next operation, the fur skins are cleansed thoroughly to free the hair or wool from dirt and other impediments. This process is known as "scouring" and it is carried out with the help of sawdust. Here the skins are left in moist sawdust for 24 hours, or, still better, the sawdust is applied to the hair side before the skins are drummed on a rotating drum for about one hour. The humid sawdust absorbs the dirt and separates the hairs. A thorough scouring effect can be obtained by raising the temperature inside the drum to 35° C. When the skins are greasy, the sawdust is damped with a solvent like white spirit. The skins are degreased by drumming.

When no subsequent dyeing is anticipated, it is a good practice to add some kaolin to the sawdust. This, in addition to the drumming, has a good softening effect. To condition skins which have been overdried, scouring should start with partly wet sawdust followed by drumming in dry sawdust. After scouring, the adhering sawdust is removed by drumming in a lattice drum or in a wire-mesh drum or by gently beating the fur skins with sticks, or by brushing them with a stiff brush.

As a rule, stretching and drumming are not enough to obtain the desired degree of softness. In addition, therefore, the fur skins are stretched over a half-moon shaped staking knife, or knee staking apparatus. In this way, the hide fibers are separated from each other, and softness and suppleness are obtained. For preference, stretching and staking should be carried out between wet sawdust and dry sawdust drumming, and again immediately after dry drumming. The skins should be stretched more in the length than in the width.

The stretching and staking operation calls for skill and patience; otherwise the skin may be torn. Special attention must be paid to legs and neck, for they have a tendency to wrinkle during tanning.

XIV. DYEING AND BLEACHING OF FURS

The dyeing of furs requires skill and knowledge. They can be obtained only after many years of practical experience. The work involves the use of special techniques and "developed dyes," in which an insoluble colored pigment is formed on the fiber. Large dyestuff manufacturers supply precise details on the use of their products.

Killing of hairs

A special treatment — the "killing" of the hairs — is necessary before dyeing because hairs which consist of keratin are difficult to swell. Without pretreatment they have little affinity for dyestuffs.

The penetration of the dyestuff, therefore, should be more than just a superficial coloring. Any natural fat or grease should be removed to ensure an even and thorough dyeing effect.

The effect of swelling the fur or hairs and the emulsification of the fat or grease is obtained by treatment with a weak solution of ammonia, or else of sodium carbonate, which is particularly suitable for soft hair or wool.

For stiff or hard hairs, sodium carbonate or a mixture of soda and ammonia is recommended, while caustic soda is only applied to particularly hard hairy skins. If this process is carried out with the help of a brush, the concentration of the liquor should be higher than when the skins are immersed in liquor.

The concentration of commercial ammonia is normally 22 percent, and the strength of the working solution should not be more than 50 cubic centimeters per liter when brushing. The concentration of sodium carbonate solution should be about 50 grams in one liter of water. Caustic soda solutions vary from 7° to 35° Bkr.

By treating the skins in the liquor, the following concentrations are used: (a) 5 to 10 grams of sodium carbonate; or (b) 5 to 10 cubic centimeters of ammonia (of 22 percent) in one liter of water. If the two chemicals are mixed together, half of the above quantities should be calculated. The temperature of the solution should not exceed 32° C.

Any concentration which is too strong is detrimental to the hairs, for they will lose their elasticity, suppleness and shape. In extreme examples, the hair shafts and tips curve or dissolve. Moreover, the leather fiber is also affected. Hard and stiff fur skins with cracky grain are the result.

Sometimes hydrogen peroxide and ammonia are used for obtaining a bleaching effect on the hairs. As an example, the following mixture is mentioned: 50 parts of hydrogen peroxide (of 40 percent), 25 parts of ammonia (of 22 percent) and 80 parts of water.

Mordanting process

In this process, use is made of certain salts which help to fix the dyestuff on the hairs by forming an insoluble product. Before the so-called mordanting, the hairs should be washed out thoroughly. Any alkali which is left should be removed, or neutralized, by adding some acid to the liquor. The most common salts used in this process are chrome alum, potassium bichromate, copper sulphate and iron sulphate. These salts produce on the hairs a characteristic of their own — for example, chrome alum produces a reddish blue; potassium bichromate, a dark red-brown shade; copper sulphate, a very dark shade; and iron sulphate, a blue-gray shade.

By combining these salts, a wider range of shades is obtained. Iron sulphate and potassium bichromate, however, should not be used together; otherwise a precipitation follows.

To carry out the process, the fur skins are continuously moved in the salt solution. Its temperature should not exceed 30° C. The duration of the movement depends on the desired intensity, and it varies from 3 to 15 hours.

The concentration is variable and it depends on the kind of fur skins and on the shades which are desired.

For 1 liter of water, the following examples are given:

- (a) 5 to 10 grams of chrome alum and 10 to 20 grams of common salt;
- (b) 1 to 2 grams of potassium bichromate and 1 to 1.5 grams of acetic acid (of 30 percent);
- (c) 1 to 4 grams of iron sulphate with 0.5 to 2 grams of acetic acid (of 30 percent) and 5 to 10 grams of ammonium chloride.

When these salts are used in a mixture, their quantity should be correspondingly reduced. After mordanting, the fur skins are pressed or centrifuged and washed thoroughly with cold water. They are then ready for dyeing.

If the mordanting was too short, or if the solution used was too weak, the shades will not be sufficiently deep. If, however, the fur skins are excessively mordanted, no coloring effect can be obtained at all. When this happens, the fur skin should be treated with acid to make dyeing possible.

For wool dyeing, the wool must be pretreated with sodium hypochlorite. Paddles are used, and the wool skins run for five to ten minutes in water with a temperature of 20° C. to ensure that the wool skins are uniformly soaked back. For every 500 liters of water, about 1 kilogram of sodium hypochlorite is used. It is dissolved separately and added to the paddle over a period of 15 minutes.

After the last addition, the wool skins are paddled for another 20 minutes. Subsequently, hydrochloric acid is added to make the solution acid. About 170 cubic centimeters of hydrochloric acid (specific gravity 1.2) are sufficient for every 500 liters of water.

This addition should be done in portions over a period of 15 minutes. After the last addition the paddling is continued for another 15 minutes.

The wool skins are now taken out and thrown into a new liquor, which consists of 187 grams of soda ash and 187 grams of sodium sulphite crystals for every 500 liters of water. The paddle is again run for 20 minutes.

Gaseous chlorination — another method very advantageous for wool skins — is also recommended.

Bleaching

Natural white colored fur skins have generally an uneven and slightly yellow color. To obtain an even white color they have to be bleached.

Black hair pigments can also be removed by bleaching, so that nearly white fur skins will result from skins which are dark colored by nature. A good bleaching effect can be obtained by treating the hairs with hydrogen peroxide or with the fumes of sulphur dioxide. Extreme bleaching, however, should be avoided, for it has a detrimental effect on the leather properties of the skins.

Certain precautions are therefore essential, and it is a good practice to carry out the fat liquoring process in such a way that the fatty matters or oil penetrate through the entire skin. An initial treatment with formaldehyde also gives a sufficient protection.

Chrome tanned fur skins which are treated with chrome salts should not be bleached, for the bleaching process may destroy the fiber structure of the leather. Bleaching with hydrogen peroxide is also practiced, if the furs are to be dyed. Here the bleaching process should be carried out between the killing, mordanting and dyeing processes. The fur skins are immersed in the bleach liquor, which has a temperature of 32° to 35° C.; and a bleaching effect is obtained after an immersion of two to six hours. The bleaching liquor contains 600 cubic centimeters of hydrogen peroxide (of 3 percent) and 100 cubic centimeters of water, to which some ammonia is added. The pH of this liquor should be continuously checked; for when the alkalinity is too high, it reduces the bleaching effect, and when the pH of the liquor falls below pH 7, no bleaching can be obtained at all.⁴

Sulphur bleaching is also practiced. For this purpose the damp fur skins are hung in an airtight chamber, which is divided into two compartments. The skins are hung in the larger compartment, while sulphur is burned in the other one. Thus the fur skins are exposed to the sulphur dioxide fumes until the desired degree of bleaching is obtained. A check must be made, now and then, to ensure that the burning of the sulphur is regular.

See Appendix on "pH Value in Tanning."

Dyeing

The dyeing process can only be carried out successfully if the pretreatment — that is, killing and mordanting — has been satisfactorily effected. The following factors can also greatly influence the dyeing process:

- (a) the concentration of the dye bath;
- (b) the duration of the process;
- (c) the temperature of the dye bath; and
- (d) the acidity (or alkalinity) of the dye bath.

Different processes and materials which can be applied are mentioned below.

NATURAL DYES

There are a number of natural dyes in use — for instance, haematin, fustic or yellow wood, leaves of sumac, gallic acid and others.

Only fur skins mordanted with salts can be dyed with natural dyes. The dyes form insoluble lakes with the salt on the hairs, while the final fixation and shade are developed through the combination of oxygen from the air.

The fur skins are either drawn through the dye bath or remain for some hours in the dye solution at a temperature which does not exceed 45° C. Vegetable dyes have a beneficial influence on the properties of the hairs and the leather, for a certain tanning effect is obtained on both the hairs and the skin.

Soft hairy or woolly skins, in particular, benefit by this treatment. Dyeing with wood dyes is still practiced for high-quality furs, such as the so-called Persian fur skins.

“ DEVELOPMENT ” DYES (ALSO CALLED “ DIAZO ” DYES)

There are a number of dyes, which are known commercially, but no further reference to their application is made here.

SYNTHETIC DYES

These dyestuff solutions, which are commercially available, are not discussed in this paper.

COLOR EFFECT WITH SALTS

The principle of producing color effects with salts is based on the use of basic lead acetate. This salt can be changed into lead sulphide by using sodium sulphide, whereby yellow, orange or redbrown shades are obtained. Special nuances can be effected by brushing the hair tips with the lead salt.

Dressing sheepskins for wool rugs

It is easy for a rural tanner to make attractive wool rugs from sheepskins. Preferably, pure white skins should be used.

The best results are obtained from sheepskins which come straight from the butcher. They should be thoroughly washed on both sides with soda and soap in warm water until all traces of dirt and blood are removed. If green skins are unobtainable, the dry skins should be soaked in the same way as other skins. As the next step, the fat must be removed. This is the most important operation, and it should be carried out very carefully. The skins are first stretched on frames similar to those used for the manufacture of parchment (Figure 72).

The flesh side is treated evenly with a paste which is made of Fuller's earth or whiting (calcium carbonate or chalk). The skins are then exposed to moderate heat, near a stove or in the direct sunlight, until they are dry. The fat will soften and pass into the paste. This should be scraped off after a day or two. The process can be repeated when handling very fatty skins.

If a snow-white color is required, the skins can be bleached. The skins are removed from the frames and passed through a bath which contains a weak solution of bleaching powder (chloride of lime), or hydrogen peroxide. They are immediately wrung out and returned to the frame. To have them tanned, alum paste is applied to the

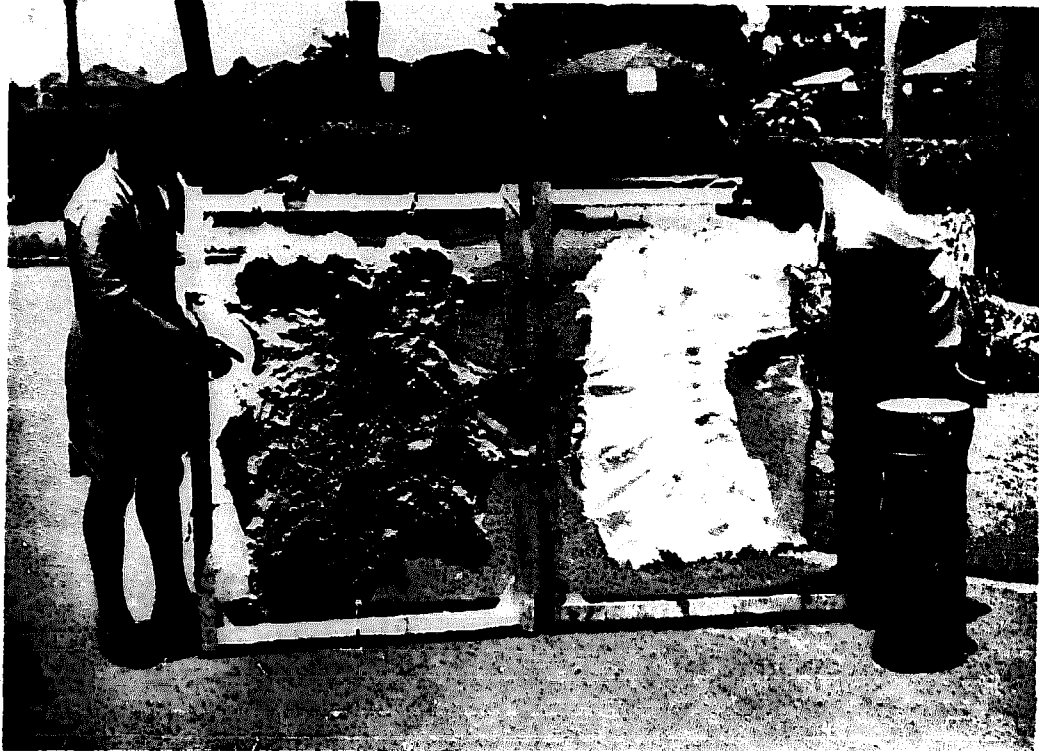

FIGURE 72. - Dressing of sheepskins stretched in frames. Tanner on right is applying a paste of whiting to degrease skin.

Courtesy: Kenya Information Office, Nairobi

damp skins, on the flesh side only. It must never come in touch with the wool. The frames are put into a dark room: and when the skins are dry, they are taken out, and the paste is scraped off. The skins are again dampened, and a second application of paste is made.

Finally, the skins are finished, according to the methods already described in Chapter XI.

XV. PREPARATION AND TANNING OF REPTILE SKINS

Snakes and lizards

Reptile skins, such as crocodile, alligator, lizard and snake, make very attractive and durable leather; even East Asian frog skins are tanned. Unfortunately, owing to faulty preparation, reptile skins often reach the tanners in too bad a condition to tan. The usual blemishes are cuts, gouge marks, bad shape, scale slip and putrefaction. Damage due to delayed flaying or dragging over rough ground is also common. So is damage due to overdrying or overexposure to the sun, to distortion and overextension, or to the action of beetles after the skins have been dried. Damage due to parasites or ticks may have occurred before death. These skins should not be mixed with undamaged skins; they should be handled separately.

If first-class material is to be obtained, the correct methods must be used to catch and to collect reptile skins.

Preparation of snakes and lizards

The catching and killing of snakes and lizards must be done without damage to the skins. Spearing a python and battering it to death with sticks and stones will not secure a perfect skin.

Flaying should start immediately before decomposition can take place, and proper ripping lines should be used before the removal of the skin begins. Fleshing and scraping off any loose meat, fat or tissue and removing blood must start immediately after the skin has been taken off.

Lizards and snakes are opened down the belly, from the tip of the chin to the end of the tail; they are not opened on the back. Only

iguana and chameleons should be opened along the back; and their legs are cut along the center line on the lower side so as to get the full spread.

DRYING

Lizard or snakeskins can be dried either on a frame wire mesh or on a board or plank. The frames are prepared from light poles without the use of nails. They are held together by bark or twines, so that they can be easily adjusted to the size of the skin. Tiny holes are made on the edge of the skin at intervals of less than 10 centimeters to take string. The skin is stretched in the frame, while care is taken not to apply too much tension. Drying on a plank can be done in the following way.

The skin, flesh side up, is nailed to the board or plank with aluminium nails. These are 2 to 3 centimeters long, and they are allowed to remain projecting above the skin. Then the skin is raised from the board and eased up to the head of each nail. This makes a clear space of about a centimeter under the skin, and it allows the air to circulate beneath.

Care must be taken that a direct sun does not scorch the skin. On all occasions, therefore, it is better to dry in the shade.

SALTING

Very good results are obtained when salting is used in place of air-drying. Only fine salt should be used for salting lizard and snakeskins, for the crystals of coarse salt can cause damage by piercing into the corium.

If the skin is to be used within a week, one salting is sufficient. When it is necessary to preserve skins for a longer period, however, a further application of salt is sometimes advisable before drying out.

Salting should start immediately after the meat has been scraped from the skin; and the salt is rubbed evenly into the flesh side. The skins are then kept flat, so that the brine can drain off easily. Any excess salt can be removed after 24 hours, and this avoids blood contamination, if the skins were badly washed. The skins can be dried after the first salt has been taken off. They are then said to be "dry salted."

The second salting of wet stock starts the next day. First, the old salt is shaken out. If it has formed a crust, this can be broken by gently rubbing the skin. New clean, fine salt is evenly rubbed into the surface again, and the skin is rolled, flesh side inwards, from tail to head, so that a neat bundle is formed. Throughout the salting, it is essential to keep the stock in a wet condition by covering it with wet bagging.

Lizard and snakeskins, as will be described later, can also be preserved and exported after a light tannage.

Vegetable tannins are used only on skins which are not required to remain white. As a rule, an immersion for two days in tanning liquor made from acacia pods is a sufficient treatment.

Wet salted lizard and python skins are best shipped in wooden casks packed in a similar way to pickled pelts.

Dried goods in bales must be protected against beetles. Sprinkling with naphthalene has been used for many years. The use of modern insecticides in the form of DDT or gammexane powders, however, assures a full protection.

Crocodiles

Few workers realize that crocodile skins must be treated with greater care than lambskins. Prolonged and direct exposure to the sun is injurious to sheep- or goatskins, but even a brief exposure rapidly damages crocodile skins.

Crocodile bellies are valuable. Yet many factors make them susceptible to damage. For this reason, a brief description of the methods used to obtain the best raw material is included in this chapter.

Various methods are employed for capturing crocodiles. They depend on the local conditions and on the skill of the hunter. Whether shooting or netting, harpooning or noosing, drowning with a weight or poisoning, blinding with a torch or pole-axing, trapping or baiting on a hook is the chosen method, a number of rules must be observed. They are now described.

1. The belly part of the skin must suffer no damage. Wounds caused by spears, harpoons or bullets, or any other injuries which occur during the killing and securing of the animal, must be restricted, if possible, to the head and back.

2. Ideally the crocodile should be removed from the water immediately. The carcass should not be left in the water for more than eight hours and certainly not until it "blows" and floats to the surface; for the skins from these carcasses, even though they show no substantial damage during flaying, may be useless to the tanner.
3. The carcass should be dragged out of the water upside down, so that the back, and not the belly, comes into contact with the ground.
4. No time should be wasted between flaying, fleshing and salting. From the moment the carcass has been landed until the skin is salted, speed is essential. This is not only because there is a danger of putrefaction, but also because the skin dries out and hardens rapidly and will resist the absorption of salt.
5. The skin should never be exposed to direct sunlight: for the sun dries too rapidly, and the scales take on an oily, transparent appearance. This condition interferes with tanning. Only the belly part of the crocodile skin can be converted into leather, for the back is covered with very hard bony scales and it is horny. The backs, however, are sometimes used for decorating such articles as handbags and cigarette cases.

SKINNING

The hunter should aim at obtaining a properly shaped belly skin — from the snout to the tip of the tail, including the legs (Figure 73).

The basic incisions, which are called "ripping lines," should be made in this way:

Head. Separate the skin on the neck from the body under the hard disc on the top of the neck. Cut downwards inside the jaw, near the jawbone and along the lips until the two cuts meet at the front (see A on Figure 74).

Body. Make two long incisions from the back of the head and along the body. These cuts should start at the initial cut and end at the tail fin. Two rows of scutes should be left on each side (see

B on Figure 74). This is important, because crocodile skins are sold by the width across the belly (Figure 75).

Legs. Each leg should be opened in the following way. Hold the leg firmly at the "wrist" and pull it away from the body; make an incision in the middle of the top of the leg from the main ripping line over the point of the elbow to the "wrist" (see C on Figure 74); cut around the "wrist" as near as possible to the foot (see D on Figure 74). This produces a piece of skin which has light-colored scales surrounded by an even, dark edge. It is most important, when opening up the legs, to cut through the skin over the point of the elbow; otherwise a "pocket" is formed. This defect lowers the price on grading.

Tail. It is possible to get the skin off the tail by working downwards from the main ripping line. It is better, however, to gain access by cutting out a triangle; the line between the hind legs is the base of the triangle, and the tip of the tail is its apex. Remove the triangle, and this will facilitate access to the tailpiece. On large crocodiles, which are over two meters long, the last 15 to 20 centimeters of the skin from the tail can be pulled off. On smaller specimens, however, the skin must be separated with a knife right to the tip.

When flaying, the skin should be pulled away from the body with one hand; for the knife is used only to cut through the connecting tissue. This eliminates damage by cuts and scores.

FLESHING

As soon as the skin has been separated from the carcass, it should be placed on a completely flat surface. Any surplus meat, fat or tissue should be scraped or cut off.

WASHING

Blood and dirt interfere with the salting. The skin, therefore, should be thoroughly washed — or, preferably, scrubbed with a brush — while water from above is poured over it.

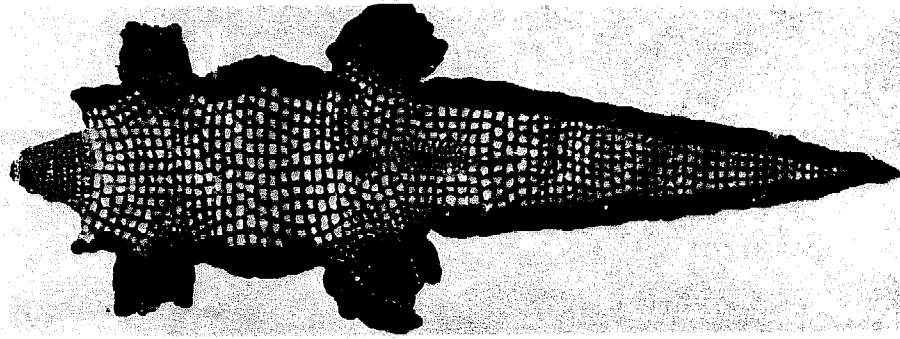

FIGURE 73. - *Properly flayed crocodile belly.*

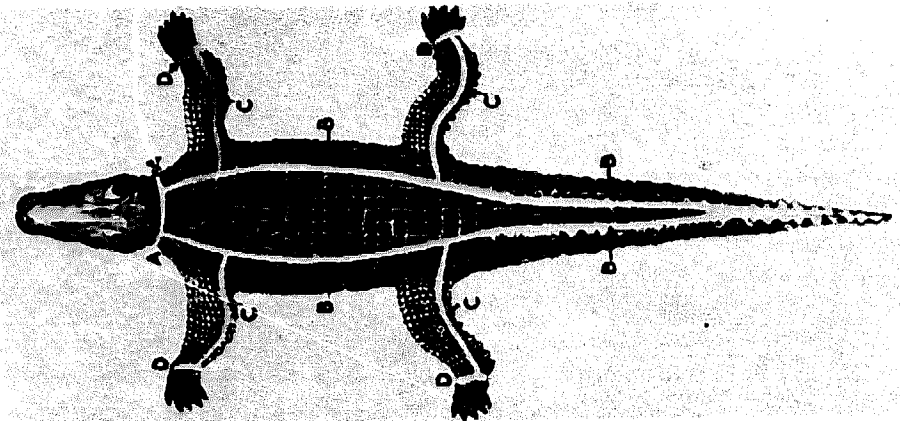

FIGURE 74. - *Proper ripping lines to flay a crocodile.*
Courtesy Kenya Information Office, Nairobi

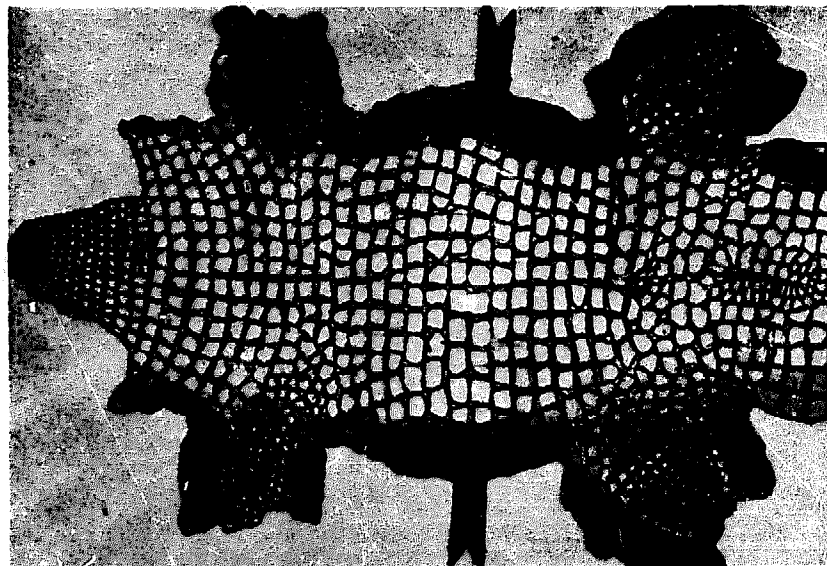

FIGURE 75. - *Crocodile skins are measured across the widest part of the belly.*

FIRST SALTING

Salting is the most important and intricate operation, and it requires the greatest care. Only fine, clean, dry salt, free from dirt and blood, should be used; for coarse salt does not facilitate penetration. The salt is rubbed very thoroughly and evenly into the wet skin, on the flesh side only.

DRAINING

By putting the skin in the shade and by draining off the brine, a great part of the skin moisture can be removed immediately after the first salting. The skin can be put over poles or wire, with the flesh side uppermost, until dripping ceases. Great care must be taken that no sunlight beats directly on the skin (Figure 76). If, however, a second salting is anticipated, no drying effect whatever should be allowed to take place.

SECOND SALTING

The draining should not take more than one or two hours. The second salting can then begin. This is a repetition of the process used for the first salting; and the same precautions are taken.

TRANSPORT

After these two preliminary operations, the skins are taken to a storehouse for final treatment. For transportation, they should be rolled, scales inwards, and there should be a layer of salt between each skin.

CURING

In the curing process, the old salt is completely shaken off. It may be necessary, however, to examine the flesh, and any superfluous salt should be scraped off. On no account should the skin be placed on earth; it should be placed on a concrete floor or wooden platform. This concrete floor or platform is covered with a layer of 3 to 6 centimeters of salt, and the first skin is placed, scale side

downwards, on the salt; the flesh side is covered with a 6 centimeters of salt. Further layers of skins are added in the same way — that is, a layer of skins, flesh up, covered with a layer of salt. In this way a “pack” not more than 60 centimeters high is made. If this height is exceeded, damage through pressure may result.

It takes about three weeks to cure the skins and to prepare them for shipment. As the bottom layer of skins cures more quickly, it is advisable to alter their positions after ten days. This is done by placing the top skin on the floor beside the first pack and by building a new pack with the skins in reverse order. The same salt can be used, provided no red coloring is observed. This should not occur if a preservative has been used.

PACKING FOR SHIPMENT

The skins are first removed from the pack, and the salt is shaken off without beating; for beating may damage them.

Each skin is now evenly covered with a little fresh salt. Rubbing is not necessary because cured skins absorb very little additional salt. Each skin is then folded, as shown in the diagram in Figure 77. First, the sides are folded along the lines A and D; then the head is folded in along the line B, and finally the tail along the line C. Sufficient salt should be placed in all the folds of the skin.

The skins can now be packed in clean sacks. They are placed tightly, one on top of the other, until the sack is three-quarters full. The sack is then closed and placed in another sack, which is sewn up. In this way, a double thickness of sacking gives the necessary protection against drying out.

Although this method gives good results, crating, in spite of its higher costs, is to be preferred. Care should be taken that no nails penetrate the crate, which should be well lined with sisal-craft or any other suitable material. The rectangular folded (not rolled) skins are packed very firmly, so that there is no possibility on any movement which might cause damage by friction. They should be so packed that no spaces are left, either in the corners, or at the top, before the lid is nailed down. Up to 450 kilograms of crocodile skins can be packed in this way in one crate. The crate should be strengthened with three or four bands of hoop iron.

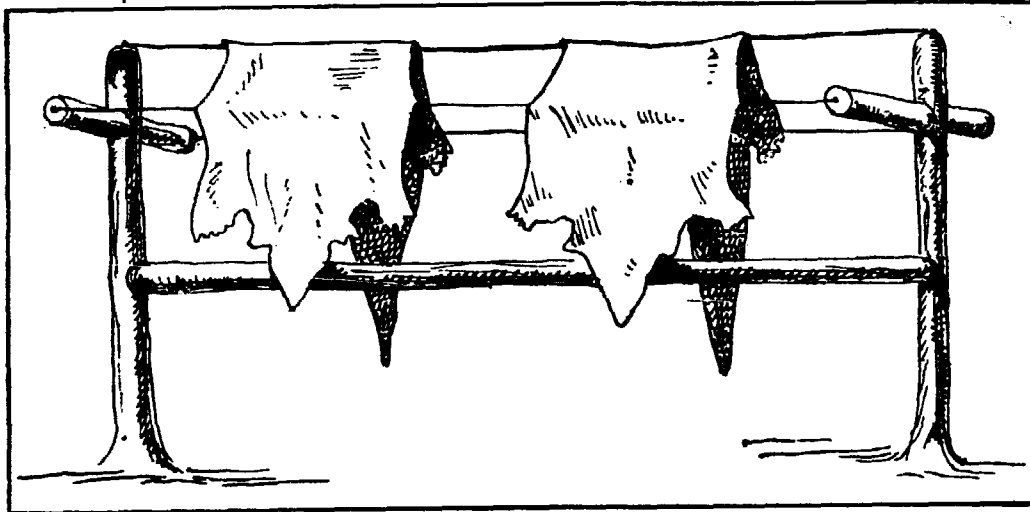

FIGURE 76. - *Draining rack for crocodile skins.*

Courtesy Mrs. Erica Mann

Progress of work at tannery

SOAKING

When the goods reach the tannery, the first step is to inspect and sort them into bundles of the same animal and origin and size. It is inadvisable, for example, to tan python skins and small snake-skins, or crocodiles and iguana, together.

Meat, fat and any loose tissue should be removed while the skin

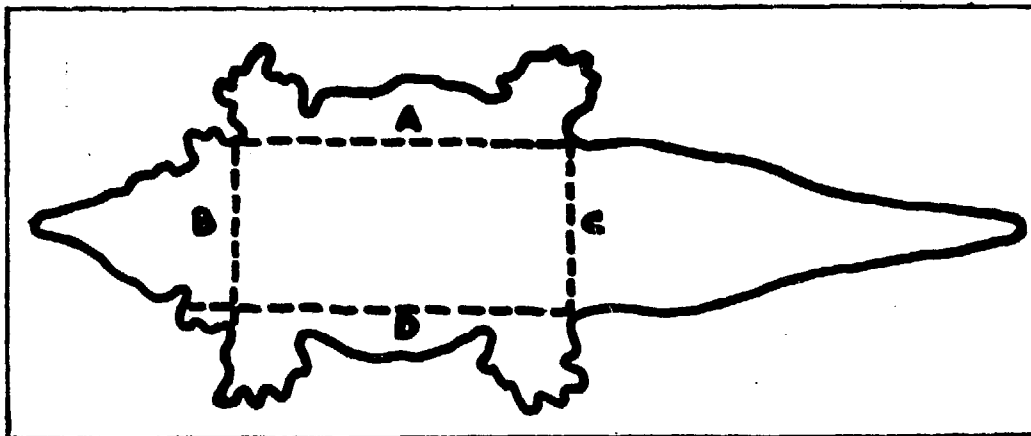

FIGURE 77. - *Proper folding lines for crocodile skins.*

Courtesy Mrs. Erica Mann

is still only partially soaked. If this is delayed until the whole skin becomes soft, putrefaction may begin again and damage the skin. The addition of 0.3 percent washing soda reduces the danger of putrefaction and increases the swelling.

If running water is not available, the goods should be soaked in at least three changes of fresh water. In the first two changes, they remain for only a few hours. They can remain in the third change until they are completely soft.

Skins which are not completely softened after being soaked for 24 hours in a 3 percent solution of washing soda may require careful mechanical "kneading" and further soaking.

LIMING

Only those skins which are completely soaked through, including their thickest parts, should be limed. At first, they should be placed in mellow lime and left for half a day. They should then be transferred to a fresh lime which contains 5 percent lime and 800 to 1,000 percent water, calculated on the dried weight of the skins.

It is advisable, while the liquor is being plunged (mixed), to pull the skins out of the lime from time to time and to allow them to drain over the edge of the vat or on draining boards before putting them back for further liming.

FLESHING AND SCUDDING

The skins are ready for fleshing and scudding when the transparent membrane on the scale comes off easily. Scudding should be carried out in the direction off the scales, *not against* them. Care should be taken to remove the membranes completely — in particular, from the large squares on the bellies, where they tend to adhere strongly. Fleshing must be complete; for even the smallest amount of meat interferes with the tanning.

RELIMING

After scudding and fleshing, the skins should again be immersed in fresh lime liquor, containing 5 percent lime and 7 percent common salt, for not less than five days. They are then ready for rescudding.

These preliminary operations before tanning must be carried out with great care, particularly to avoid scratching the grain during scudding.

WASHING

After liming, the skins, wherever possible, should be washed under running water. If small numbers are being treated, each individual skin should be rubbed and wrung, and again washed.

DELIMING

Ammonium chloride is a most effective deliming agent. The immersion of washed skins in 2 percent borax or boric acid solution overnight is also practiced. The use of strong acid, such as sulphuric or hydrochloric, is not advised.

BATING

A pigeon or dog manure bate may be used; but, for a better control, pancreatic bates should be employed. It is impossible to state the time that bating should take, but great care is necessary to ensure that the skins are neither overbated nor taken out before the bating is complete.

DRENCHING

The immersion of skins in fermented bran gives a finer leather. It is worth the extra trouble.

The greatest care is needed to avoid taking the skins out of the drench before deliming is complete. Any lime left in the skins makes the finished goods hard and liable to crack. Thus the use of a phenol phthalein indicator is most necessary.

Alum tanning

Unlike crocodile bellies, which are appreciated as leather in many colors, snake and lizard skins are usually sold in their natural color. Here alum tanning can be followed. This tanning actually accen-

tuates the difference between the white and brown, or black, of the raw skin.

Alum tanning is best divided into two operations: (a) tanning proper; and (b) fat liquoring.

TANNING

For every 100 kilograms of wet reptile skins, the following ingredients are used: 5 kilograms of alum, 3 kilograms of common salt, 12 kilograms of flour, 1 kilogram of sulphonated oil, and 5 kilograms of china clay. Water is added and the ingredients mixed together until a thin paste which has the consistency of porridge is obtained.

If a drum is available, half the amount of this paste is put in it, together with the skins; and the drum is kept in slow motion for about one hour. Then, from the paste which now remains, a twelfth part is added after every half hour. Within six hours, therefore, the whole amount of the paste will have been used. This procedure, which is called "strengthening," ensures that the ingredients absorbed by the skins are continually replenished. After this operation, the skins are taken out and hung to dry.

FAT LIQUORING

This starts the next day. A new paste is prepared from the following ingredients for 100 kilograms of wet skins: 3 kilograms of flour, 5 kilograms of oil (olive, groundnut or cottonseed) and 5 kilograms of egg yolk. Water is added and constantly stirred until all the ingredients form a smooth thin paste.

The skins are put back into the drum, together with all this paste, and turned for one to two hours. To avoid the drum rubbing which results in rubbed grain, the skins should not be turned for too long a period. After this operation, the skins are ready for ageing — that is, for hanging in a cool, dark place.

As alum, unlike vegetable tannins, does not stain leather when it is in contact with iron, a steel drum or a butter churn can be used. If neither is available, it is possible to use a simple wooden vat and to trample the skins and the paste with bare feet for the same length of time as is recommended for drumming.

Vegetable tanning

If vegetable tanning is used, the choice of tannin must be carefully considered so as to obtain the required color for the skins. Pure white leather can be obtained only with alum tanning, or with synthetic tannins combined with a bleach; and this process is not easily mastered by rural tanners.

Without bleach it is possible to obtain a whitish leather by using gambier, sumac or acacia pods, for these produce a light colored, flexible leather.

Very light lizard or snakeskins can be tanned quickly by suspension in a barrel of tan liquor. The initial strength should be 1° Bkr., and this can be gradually increased to 5° Bkr. by adding stock solution to the original liquor.

The skins can be tanned in five days. If larger numbers are tanned, it is much better to use five different vats which have the successive strengths of 1° Bkr., 2, 3, 4 and 5° Bkr. The skins are suspended on sticks which rest on the edges of the drums. They are totally immersed in the liquid. For at least the first two days, they are frequently shaken or lifted up and down, and great care is taken to prevent them from touching each other. They are transferred daily from one vat to the next until they reach the fifth and strongest vat. The surface, exposed by a cut through the skin with a sharp clean knife, shows when tanning is completed.

Heavy crocodile bellies require heavier concentrations of liquor and a longer time. The initial liquor strength should be 2° Bkr. The strength is gradually increased by 2° to 10° Bkr., and the skins are left immersed for two days in each liquor. The four initial liquors will be used for eight days. After this, the skins should be transferred to a 15° Bkr. liquor and kept there. As a rule, five to eight days are sufficient in the last and strongest vat (20° Bkr.). Only for exceptionally large and thick crocodile bellies are liquors of concentration higher than 25° or 30° Bkr. required.

Finish

Fat liquoring of vegetable tanned lizard and crocodile skins does not differ from the methods described for other types of leather.

Any oil mixed with sulphonated cod liver oil gives good results. Linseed oil can be used as a top finish for brown or dark colored leather.

The leather should be stretched on a wooden table, fixed by means of nails or pegs, and brushed with linseed oil. As a general rule, lizard and snakeskins should be stretched while they are being dried; they should not be just hung over a wire. This method of stretching ensures a straight undistorted shape.

The tanned reptile skin can be finished by using any of the finishes previously described in Chapters X and XI. A sharp contrast is desirable in snake and lizard skins between the white and black of the natural markings. The finishing materials which are used—such as gelatin or blood albumen—must be transparent and colorless, so as not to obscure the character of the natural markings.

When slicking reptile skins, the action must be with, and not against, the lie of the scales; otherwise damage is done. The edges of the slickers should be perfectly smooth to avoid scratching.

Some tanneries specialize in the production of chrome-tanned crocodile leather. This is a highly complicated process, and one which rural tanners are not encouraged to undertake.

XVI. PARCHMENT AND VELLUM

The art of preparing parchment and vellum is more than a thousand years old. Today, in spite of its simplicity, very few people know how it is done. In the distant past, it was kept a secret in families and in monasteries, and the knowledge was handed on from worker to worker.

The process is simple and cheap; no expensive tool nor machinery is needed; and as there is always a good market for parchment and vellum for bookbinding, lampshades and fancy goods, the art ought to be revised.

Parchment, as a rule, refers to the flesh split of a sheepskin; *vellum* is made from stillborn or very young calves, kids and lambs. Greater care, however, is required in the preparation of vellum, for the raw material is delicate and easily damaged.

Select only the best quality skins, free from scratches, pimples, scabies or other irregularities.

The only equipment needed is a timber frame of 5 × 8 centimeters. This frame, which is called the herse, should be approximately 1.2 meters wide by 1 meter long. Eight holes of 1 centimeter in diameter are drilled in each side of the frame. Thirty-two wooden pegs, similar to those used in a violin, are fitted in these holes. They should be some 12 centimeters long and shaped like a key. A hole of 0.5 centimeter in diameter, 8 centimeters from the pointed end, is drilled through each peg to take a string, or a thin reim (Figure 78).

Parchment and vellum can be made on a simple frame without pegs, by attaching the string to the frame itself, but the quality of the finished product will not be so good as that produced on a frame fitted with pegs.

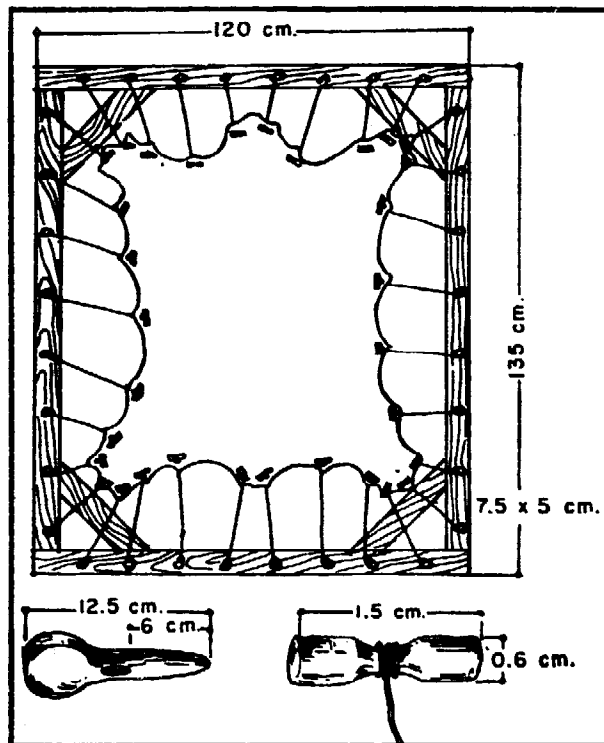

FIGURE 78. - *Frame with pegs and keys used for parchment making.*

Courtesy Mrs. Erica Mann

Liming

The skins are first thoroughly washed, soaked and limed. The liming is the most important step in the process. It must be done carefully and in the following way:

1. The skins are put in mellow lime — that is, lime through which skins have already passed — for a week.
2. They are then immersed in new lime for another week. It is advisable to stir the skins several times daily and to take them out for an hour to drain over the edge of the liming vat or cask before returning them to the liquor.

After 15 days of liming, the skins are ready for unhairing and fleshing. This is done on a beam with a scudding and a fleshing knife as with other hide or skin. Alternatively, it can be done with a knife on a flat table.

The skins should now be washed repeatedly in several changes of water, until they are completely clean and more or less free from

lime on the surface. They should then be wrung out like cloths to remove excessive moisture.

After washing, the skins are ready for lacing and stretching. Small slits or punch holes — 32 in all — are cut evenly round the perimeter. A string or reim is passed through each hole and held in position with a small piece of wood, which is of pencil thickness and called a "toggle." The other end of each string is threaded through the hole in the peg, and the peg is inserted in its hole in the frame. The neck and tail are first secured. Then the skin is stretched and fastened evenly. The lacing is done on alternate sides to obtain an even tension until each reim is attached to its peg. It is customary to stretch the skin more in length than in breadth. By twisting the pegs, the tension can be gradually increased.

Shaving

When the skin has been evenly stretched in the frame, hot water (80° C.) is thrown on it from buckets, while the lacings are kept at their maximum tightness. At the same time, the skin is "fulled," or fleshed, to remove surplus fat and scud, to extend its area and to compact the fiber structure so as to render it nonporous. This fleshing is done with a semicircular knife or with a convex, blunt-pointed skinning knife. Great care must be taken to move the knife parallel to the surface of the skin to avoid gouging.

When the work is finished on the flesh side, small hairs, hair roots and sweat glands on the grain side should be carefully scraped off with the knife until the surface is completely smooth and clean.

Dusting

While the flesh side is still wet, it is dusted evenly and liberally with chalk, talcum or china clay. The powder is rubbed in with a pumice stone which has previously been made flat and smooth by rubbing on a hard stone or a cement floor (Figure 79). When the flesh side is complete, the same treatment is given to the grain side, which needs little rubbing.

The skin is now left to dry. The best results are obtained by

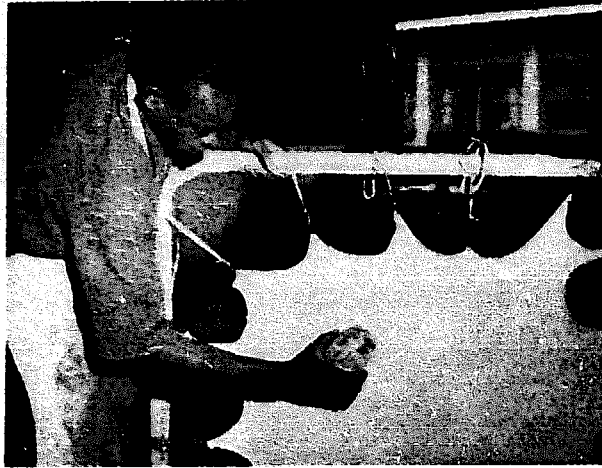

FIGURE 79. - *Operator using pumice stone to prepare parchment.*

Courtesy Kenya Information Office, Nairobi

keeping the skin out of the heat and in a dark room. On no account should the parchment or vellum be exposed to the sun or to the wind; for irreparable damage can be done by what is termed "lime blast."

Finishing

When the parchment is bone dry, it is ready for finishing. While still in the frame, it is laid flat on a table which has been covered with a blanket. For large-scale operations, a table can be padded in the same way as an ironing board. The parchment is rubbed, in circular movements, with the wool side of a sheepskin. Any unevenness or spots should be removed by rubbing with a pumice stone. Grease spots are due to inadequate liming, and they can be removed by rubbing in a 5 percent borax solution with a stiff brush. They are also removed by rubbing in a paste of whiting to the wet skin and allowing it to dry out. If necessary, this operation must be repeated.

If a gloss is needed, the parchment can be coated with the white of an egg, which is rubbed on it with cotton wool.

The parchment is now ready to be removed from the frame. It is trimmed by cutting off all the irregular corners and punch holes. Then it is rolled and stored in a dark, dry place.

XVII. LEATHER DYEING

Leather dyeing, although it has been known since time immemorial, is difficult and tricky. It requires an intimate knowledge of the preparation of leather before dyeing, the application of suitable dyes, the use of mordants and various kinds of after-treatment. Dyeing leather is much more difficult than dyeing cotton because cotton piece goods or thread always absorb the dye uniformly, while the leather dyes differently on shanks, on shoulders or along the backbone.

It is beyond the scope of this Development Paper to mention every dyeing method; only brief descriptions of the more common methods are given in this chapter with the object of helping the rural tanner, while he is still a beginner. Some detailed processes will be explained later for the benefit of the more advanced tanner.

Dyestuffs used for coloring leather are of two types:

- (a) natural — that is, those derived from plants or animals; and
- (b) artificial — that is, those prepared synthetically.

Natural dyes

Coloring matters of natural origin are widely distributed. Every part of the globe has its own examples.

Natural dyes were the first to be used. Even though artificial dyes have largely replaced them today, the rural tanner is well advised to start working with natural dyes before attempting experiments with the synthetic dyes.

Natural dyes cannot be used by themselves: for they will not stay on the leather. They must be fixed by means of certain chemicals

which are called "mordants" or "strickers." The same dye will give different colors, according to the mordant which is used.

The best-known natural dyes are:

Logwood — This is the natural dye extracted from campeachy wood, a large tree (*Hematoxylon campechianum*), which grows in the West Indies and Mexico. The dye is extracted by boiling chips of the red-brown wood in water. It is sold as solid or liquid extract and as wood chips.

Logwood gives different colors if it is used with the following mordants:

Logwood and lime water	Dark violet
" " alum	Plum
" " copper sulphate	Dark red
" " dichromate of potash or sodium .	Black
" " ferrous sulphate	Violet black

Logwood is generally chosen to produce a black color on vegetable tanned leather when iron salts are used as mordants. First, a 3 percent solution of logwood is applied to the leather; then a solution of 3 percent ferrous sulphate and 0.5 percent copper sulphate is brushed on. If a deeper black is desired, a little ammonia and 0.5 percent fustic — a yellow natural dye extracted from the yellow Brazil wood of the species *Morus tinctoria* — can be added to the solution of logwood.

Fustic — This is known also as Cuba wood and is extensively used as a yellow dye. It is obtained from a tree, *Chlorophora tinctoria*, which grows in Brazil, Mexico, Cuba and Jamaica. It is sold either as liquid or as solid extract, or as ground wood.

The following tints are obtained by using fustic with different mordants:

Fustic and lime water	Orange
" " alum	Bright yellow
" " lead acetate	Yellow orange
" " copper sulphate	Dark green

Indigo blue — The indigo plant (*Indigofera tinctoria*) is grown commercially in India, China, Japan and Indonesia. The dye is extracted from both seeds and leaves; the yield from the leaves is higher than the yield from the seeds. The cut plants are first extracted

in vats under fermentation. The liquid which contains flakes of coloring material undergoes further treatment until it is dried and pressed into cakes.

For dyeing leather, an infusion of indigo with ferrous sulphate and slaked lime is used. After this application the pieces of leather are hung out of doors, where the blue color develops by oxidation.

Cochineal — This is a scarlet coloring material obtained from the dried, ground body of a female insect (*Coccus bacti*) which resembles the ladybird and lives on cacti in Mexico, Central America and Java. Cochineal is used with tin mordants.

There are many shrubs, trees and fruits which yield red dyes, and they are used under a variety of names.

A good example of how a natural dye and mordant can give a brilliant red is the age-old art of dyeing Morocco leather. The process is as follows:

1. The skins are softened in water and stretched out completely flat.
2. Alum, or tin salt, dissolved in water, is applied as a mordant.
3. A cochineal bath is prepared by boiling the scales in water with a little tartar emetic.
4. The skins are immersed for half an hour in this bath, with continuous handling, at a temperature of about 43° C.
5. The skins are then taken out, rinsed, drained, laid flat on a table, oiled with linseed oil on the grain side and drained.
6. When the skins are dry, a finish prepared in the following way is applied: 42 grams of shredded soap, 5 grams of lard, and 7 grams of carbonate of soda are boiled together with sufficient water to dissolve them. After the mass has completely dissolved, 42 grams of flax seed decoction are added.
7. The finish is applied lightly with a sponge or cotton wool pad and then allowed to dry. Then the skins are rubbed with a piece of flannel to produce the desired gloss.

Further examples of the use of natural dyes are found in Nigeria. After years of trial and error the Nigerian tanner has learned how to obtain excellent results from local natural coloring matters.

Yellow is obtained from the tuberous rhizome of a shrub which grows abundantly in dry areas. Salt from Lake Chad is used as a mordant. The principal salt responsible for this color is sodium carbonate.

Red is obtainable from guinea corn leaf sheaths, dried and powdered. Lake Chad salt is again used as a mordant, and lime juice provides the necessary acid.

Black is obtained by first dyeing the skins red with guinea corn sheaths and then using as a mordant the smelted and vitrified clay and iron which are obtained from blacksmiths' hearths. This vitric material is mixed with sugar and water.

The Sudanese tanner uses acid produced by the fermentation of dates to obtain a brown or tan color. Red color is obtained from red wood which is imported from Turkey and mixed with alum and some powdered local wood.

Wherever tanning is a home industry, the rural tanner can learn from the cotton dyer or basket and mat worker what local plants yield dyes. He should then experiment with small pieces of leather and use these dyes with different mordants.

Artificial dyestuffs

The tanner divides artificial dyes into three main groups:

Acid dyes are readily soluble in water, and they require no mordant for their vegetable or chrome-tanned leather. Such dyes are: Orange G, Metanil Yellow, Fast Red, Resorcine Brown, Acid Green, Nigrosine, Acid Black-Brown, Naphthol Blue-Black and Naphthalene Leather Yellow, Brown or Red and others.

Basic dyes can be used on vegetable tanned leather. They are favored because of the rapidity of the covering and absorption power. It is, however, essential to give the leather a preliminary treatment because basic dyes are readily precipitated by tannin. The leather, therefore, should be washed, retanned slightly with sumac or any mild tanning material, washed again and then drummed in a solution of titanium potassium oxalate or other salts, such as tartar emetic or lead acetate. This treatment not only precipitates the remaining

tannin which might diffuse out of the leather and interfere with the dyeing; it also effects the final combination of leather and dye stuff and makes the color faster to washing and to light.

If basic dyes are employed for chrome leather in the neutralized state, it is necessary to mordant with a surface retannage and to use vegetable tanning materials, syntans or natural dyes which contain tannin. Afterwards the skins should be washed, drummed in a salt, such as titanium potassium oxalate, washed again and then dyed.

Examples of common basic dyes are: Bismarck Brown, Magenta, Safranine, Methylene Blue, Basic Black, Indine Blue and Rhoduline Yellow.

Direct dyes can combine directly with chrome-tanned leather without the aid of a mordant. They can also deepen the color of vegetable-tanned leather which has been previously dyed with a basic dye, but they have little affinity with vegetable-tanned leather. They will only produce light shades on chrome leather mordanted with tannin.

Diazole Chrome Brown, Direct Blue, Direct Fast Red and Direct Black are examples of direct dyes.

Note — Acid and basic dyes must never be mixed, for they precipitate each other.

Use of dyes

It is impossible to give a comprehensive list of instructions on how to apply dyestuffs to all kinds of leather. Before attempting to dye a whole batch of skins, therefore, the tanner should first try his skill on a small piece of leather about 10 by 20 centimeters.

The manufacturers of dyestuffs supply data on the range of color, solubility, penetration and the light and wash fastness of their dyes and on how to use them.

The amount of dye used depends on many factors — among them are the type of dye, the kind of tanning, the quality of the leather, the method of application and the nature of the water — but it falls between 0.5 percent and 5 percent of the weight of dry leather.

The preparation of leather for dyeing requires patience and skill. The leather must be well washed to remove any excess soluble tannin.

Uneven or spotted vegetable tanned leather, produced by astringent tannins such as mimosa, can be dyed more easily if it is first washed (or "stripped") thoroughly in a mild (1 percent) bath of sodium bicarbonate, sodium carbonate or borax. This leather can then be retanned by using a mellow tannin such as sumac, gambier, or acacia at a strength of 1 to 2 percent in warm water, calculated on the dry weight of the leather. A drum is recommended for these processes, which should not take more than two to three hours. After retanning, the leather is washed thoroughly.

Dyestuffs should never be dissolved in iron vessels, but in wooden, porcelain, aluminium, enamelled or glass vessels; for iron may affect certain colors. The best way to dissolve dyes is first to make them into a paste with cold water and then to add more water and to heat to 70° C., while stirring vigorously. If only hard water is available, basic dyestuffs should first be made into a paste with an equal quantity of acetic acid (of 30 percent strength) before adding the hot water.

Acid dyes are made up for use by dissolving 5 to 20 parts of the dyestuff in 1,000 parts of warm water at 30° to 40° C. The amount of dye used depends on the depth of color desired. Acetic, formic or sulphuric acid is later added to this solution — that is, after the color has been absorbed by the leather. The amount of acid should be slightly less than the weight of dye used — for 2 grams of dye stuff, 1.5 grams of acid. The solution and acid may also be stirred together. As soon as the color becomes uniform, it is ready for use.

Dyeing takes about 30 minutes. If a number of skins are being dyed, the color of the bath will slowly become less intense, because the dyestuff is being absorbed by the leather. For this reason, it is advisable to add the dye in two portions to obtain more even shades before the acid is added.

Vegetable-tanned leathers are often stored in the crust state for prolonged periods. This storage may discolor the grain, spoil its appearance and make dyeing difficult. To ensure that the dyestuffs are evenly assimilated by these leathers, the following procedure should be adopted.

Drum goat and sheep leather first in lukewarm water, or, better still, draw the leather through the water; horse up for about one

hour and drum in a float of water at 30° C. for 30 minutes; and then drain.

This is followed by "stripping" in the same drum, or vat, and using about 1 to 2 percent borax or 0.25 to 0.5 percent soda ash, based on the drained or "sammed" weight for about half an hour. The leather is washed again before it is retanned with a suitable light-colored tanning material.

Basic as well as acid dyes can be used. For delicate and pale shades, however, acid dyestuffs are preferred.

Methods of application

ONE-TRAY SYSTEM

A wooden tray — approximately 1 meter long by 1.4 meters wide and about 20 centimeters deep — is used. As dyeing is only necessary on the grain side, the following method is considered to be sufficient.

Two wet skins of about the same size are "paired" — that is, they are placed flesh to flesh and immersed in the dye. On a small scale, the skins, instead of being "paired," can be folded along the backbone, grain side out.

The skins — not more than a dozen — are piled on the right hand side of the tray and then transferred, one by one, to the left side. When the bottom pair has been placed on the top of the left hand pile, they are once again transferred, one at a time, to the right hand side. This process is repeated for about 10 to 15 minutes until the desired uniform color is obtained. The skins are then taken out, rinsed in warm water and dried.

The dye must be replenished; for it becomes exhausted, or else the following batch of skins will be much paler than the first ones.

TWO-TRAY SYSTEM

When this method is used, the skins are transferred from one tray to the other, so that those which were on the top in one tray are on the bottom in the other. As a rule, ten to twelve turns are required.

BRUSH COLORING

The easiest method of dyeing is to apply the solution with a brush or pad. The skin to be dyed is laid flat on a smooth table, grain side up, and several applications of the dye are made with a soft brush or pad in even, circular movements (Figure 80).

With basic dyes which require a mordant, brush dyeing is carried out in this way:

1. About a dozen skins are laid, one above the other, on a table, flesh side down and heads towards the left.
2. The skins are moistened with clean tepid water.
3. The mordant is applied with a soft brush to the top skin, first around the edges and then zig-zag across the center.
4. This skin is then placed alongside the pile and the others are treated in a similar way, so that they are built into a new pile. The mordant should be given time to penetrate into the skins.
5. The dye is then applied in a similar manner to the mordanted skin.
6. After one coat of dye has been applied, the skin is put to one side, but not piled; and the next skin is similarly dyed. This is repeated until all skins have received one coat. The process may have to be repeated once or twice.
7. The skins are washed in running water and wrung out.
8. They are then stretched out and dried, either by nailing to a slatted frame or by hanging after slicking.
9. The finish is applied when the skins are dried.

SPRAYING

Dyes may be applied with a "flit" gun, and then a more concentrated dye solution is used. Great care must be taken to apply the dye evenly to the whole surface by moving the gun smoothly (Figure 81). After one application, the skin is placed to one side and the next skin is treated. A second or third coat may be necessary.



FIGURE 80. - *Operator applying dye with brush.*

Courtesy Kenya Information Office, Nairobi

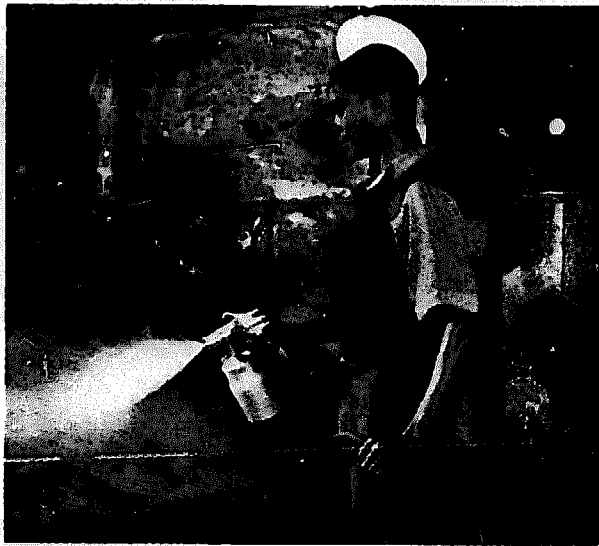

FIGURE 81. - *Operator spray-dyeing in a small tannery.*

Courtesy Kenya Information Office, Nairobi

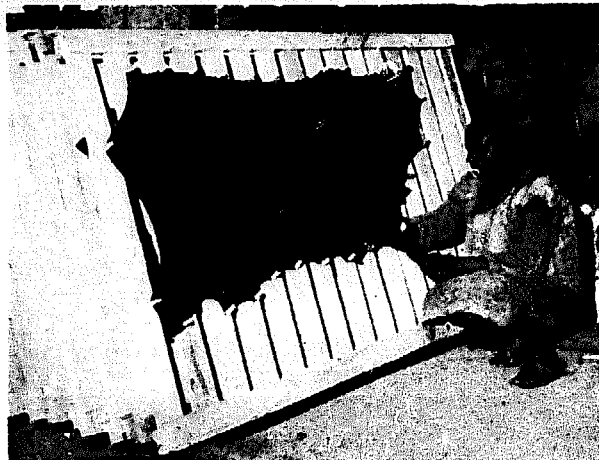

FIGURE 82. - *Operator pegging a tanned side on a frame.*

Courtesy Kenya Information Office, Nairobi

DRUM DYEING

Dyeing with acid dyes is a very simple operation, if a small drum is available. The washed skins are put into the drum, which contains hot water at 42° C. The required amount of dye solution is then added in two portions, and the drum rotates for ten minutes for each addition. After this, the required amount of acetic or formic acid is poured in, and the drum rotates for a further fifteen minutes. Then the skins are taken out, rinsed, slicked out and stretched on a board for dyeing (Figure 82).

XVIII. PLANNING A RURAL TANNERY

Once the tanner has acquired sufficient knowledge and confidence to produce quality leather, the time comes to abandon his shed in the backyard and to establish a proper tannery. Either he does this alone or he builds with other tanners a co-operative tannery. Choosing a suitable location for a tannery needs careful thought.

Site

Ideally, a tannery should have a copious supply of suitable water and allow easy disposal of waste (effluents). It should be readily accessible by road or rail; it should be situated as closely as possible to permanent sources of raw materials, such as hides, skins, tannins and lime; and it should also be in an area where skilled labor is available and near a leather-consuming area.

It is unlikely that one site will offer all these advantages. Various factors, therefore, must be considered. It is, for instance, not absolutely essential to have a market for the finished products in the immediate vicinity, for the finished leather is easier to transport than the raw material.

A new tannery should be so constructed that it allows adequate space for the planned output; it should be on high ground to allow for easy drainage and waste disposal; it should be sanitary and provide good working conditions for the laborers; it should allow the continuous flow of materials — it should ensure that hides and skins are so handled through the tannery that all unnecessary movement is avoided. Finally, it should be easy to enlarge the tannery, if the volume of trade increases.

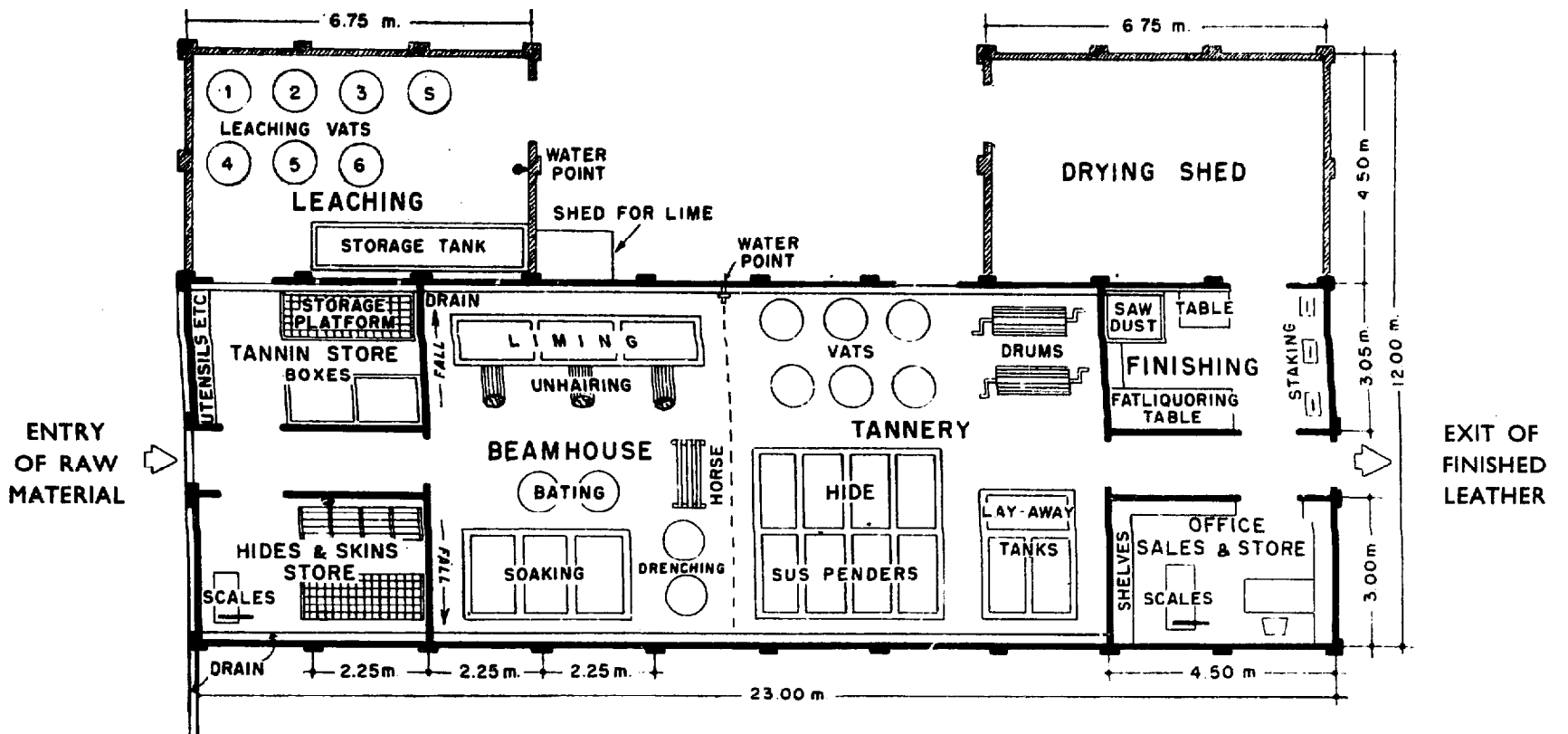

FIGURE 83. - General sketch plan for a rural tannery. Details need to be adjusted to local conditions and needs.

Courtesy Mrs. Erica Mann

Size

There are no standard dimensions for a tannery. Its size depends on the output and types of leathers to be produced, the methods of tanning and, naturally, the financial means of the owner. Once the basic parts of the building are planned and the questions of water supply, waste disposal and markets are settled, it is easy to decide upon the size.

A very simple tannery consists of one long building and two "lean-tos." The walls are made of stone, brick or timber 1.2 to 1.5 meters above ground level. The roof should be supported by stone, brick or wooden pillars. The distance between the pillars should be 2.5 to 3 meters, or else they should conform to the regulations which the government of the particular country may have made for this industry. In hot climates, the space above the walls, up to the eaves, should be closed by sheets of metal or by strong wire netting. In cooler climates, the sides of the building may be walled up: but sufficient windows or openings must be left for adequate lighting and ventilation. Light is extremely important in a tannery — first, because most processes require visual inspection and, second, because the growth of moulds in a dark ill-ventilated tannery can present very serious problems.

The following dimensions are suggested for a rural tannery which has an output of 10 to 12 hides and 50 to 75 skins per day (Figure 83). It should be realized, however, that details have to be adjusted to local conditions and needs.

A building 27 meters long and 7 meters wide, divided into:

Stores	0.5 meters long
Beamhouse	6 meters long
Tannery	7.5 meters long
Finishing room and office	6.5 meters long

By working 25 days each month, such a tannery could handle 250 to 300 hides and 1,250 to 1,875 skins each month. This output could be increased substantially if, later on, suitable machinery were installed.

The recommended dimensions of the "lean-to" sheds are 6 meters by 6 meters both for the leaching and drying sheds.

When planning a tannery, allowance should be made for enlarg-

ing the premises, if and when required, rather than starting with a building which is only just large enough. The leaching pits, for instance, should be located close to the suspenders, and provision for the crushing of barks, etc., should be made.

Roof

Corrugated iron roofs are not entirely suitable for tanneries, because iron reacts to the chemicals which are used. The moisture, always present in the tannery, condenses during the night or in cold weather, and dripping from an iron roof will stain the leather and tan liquors. Galvanized corrugated iron sheets, however, are used in large tanneries. Certain paints which are available on the market prevent the corrugated iron from getting rusty. A thatched roof is also troublesome; for the straw and dust which fall from it contaminate dyes and interfere with glazing. Aluminium, asbestos or country tile roofs are the best because they are durable and cool, and they do not spoil the work. There are, however, countries where thatched roofs are not made out of straw, but are woven out (plaited) of different kinds of palm leaves and other strong vegetable material. In many countries this is an old established small rural industry. Mats from vegetable material are also woven, and they could be used as ceilings.

To reduce condensation and increase ventilation, it is advisable to provide a ventilated ridge along the whole length of the roof (Figure 84).

Floors and drains

Floors may be made of stone, brick or concrete. Concrete should be roughened by pressing diamond-shaped weld mesh, or expanded metal, into the wet cement mix. The channels thus constructed drain off the surface water, while providing a firm grip for the feet of the workers.

The efficient removal of liquids from the tannery is essential both for the health of the workers and for the quality of the leather. Sooner or later, slippery and smelly floors, without slopes leading to the

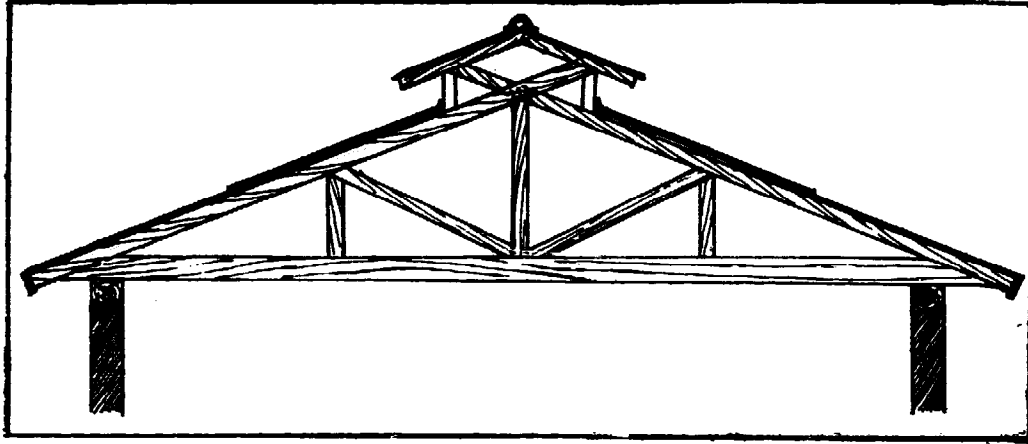

FIGURE 84. - *A possible roof construction, showing open ridge for ventilation.*

Courtesy Mrs. Erica Mann

drains or without drains at all, will cause dissatisfaction or disease among the laborers; they will also cause a lowering in the quality of the products. Many tanneries have still only one main drain, which runs along the center line of the building, and which is covered with an iron grating. It is better to have two drains which run parallel to the long walls of the tannery (Figure 85).

Simple grease traps and screens — or, better still, perforated buckets — should be installed in the drains to trap larger particles before they leave the tannery premises. This waste can be added to a compost heap and thus enrich the fields with nitrogenous material.

Basic sections

Whether the tannery is to be small or large, provision for the following assets is essential (Figure 83):

1. A store for hides and skins;
2. A store for tannins (lime, however, should be stored separately);
3. A lean-to shed for leaching;
4. A "beamhouse," also called "wethouse," for preliminary operations such as soaking, liming, unhairing, bating and drenching;

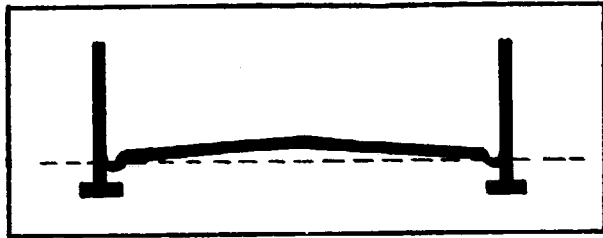

FIGURE 85. - *Cross section of tannery floor showing two drains running parallel to the long walls, as recommended for rural tanneries.*

Courtesy Mrs. Erica Mann

5. The tannery proper;
6. A drying shed;
7. A finishing room; and
8. A store for finished leather, to include an office.

STORE FOR HIDES AND SKINS

The store should be large enough for a two-month production of hides and skins to be tanned. It should also provide for storage of hides and skins which can sometimes be bought at a low price when market conditions are favorable. The store should be weather-proof to prevent spoilage by rain, well ventilated and vermin-proof; it should be fitted with a slatted platform on which the hides and skins are stored, and it should be provided with a platform scale.

STORE FOR TANNINS

As a rule, tannin-bearing materials are collected seasonally. Thus, at certain times of the year, it may be cheaper to buy more than is necessary for immediate consumption and to store the surplus until it is required.

Although this store need not be an elaborate building, full protection from the rain is essential. Tannin-containing materials should be kept on a slatted platform, and the store should be well ventilated to prevent the growth of moulds.

Lime must not be allowed to contaminate the tanning material. It is best kept in a pit or in a large, covered, wooden box, separate from the tanning material and preferably outside but protected from the rain.

LEACHING SHED

This need not be part of the building itself; for a "lean-to" shed is quite adequate. It must have a stone or cement floor; otherwise it will soon become muddy. This floor should slope inwards, towards the wall of the tannery; it should discharge into the main tannery drain, but not into the effluent drain.

Provision should be made for possible expansion — accommodation, for instance, for large slatted floored wooden vessels or whole batteries of brick, stone or cement vats to produce tanning liquor.

THE BEAMHOUSE (ALSO CALLED WETHOUSE)

Preliminary operations, such as soaking, liming, unhairing, scudding, bating and drenching, take place in the beamhouse.

It is not possible to recommend a standard size for this building, but there should be enough space for each operation.

As most of the wet work is done in the beamhouse, it is the source of most of the effluents and solid wastes — for example, hair, fleshings and trimmings. It is essential, therefore, that the floor is made of cement, brick or stone. Since the water consumption in this part of the tannery is very high, there must be provision for an adequate and quick water supply.

If cattle hides are to be tanned, preference is given to brick or cement vats. Under rural conditions, vats should be erected above ground level and not built completely into the ground; otherwise draining is difficult. A hole — about 6 to 8 centimeters in diameter and fitted with a wooden tap — should be made at the bottom of that side of the vat which is nearest the drain. The bottom of the tank should slope in the direction of the floor.

The following dimensions are recommended for vats:

- (a) two or three soaking tanks, each 1.5 meters long by 0.9 meter wide and 1 meter deep; and
- (b) three liming tanks of the same dimensions as the soaking tanks.

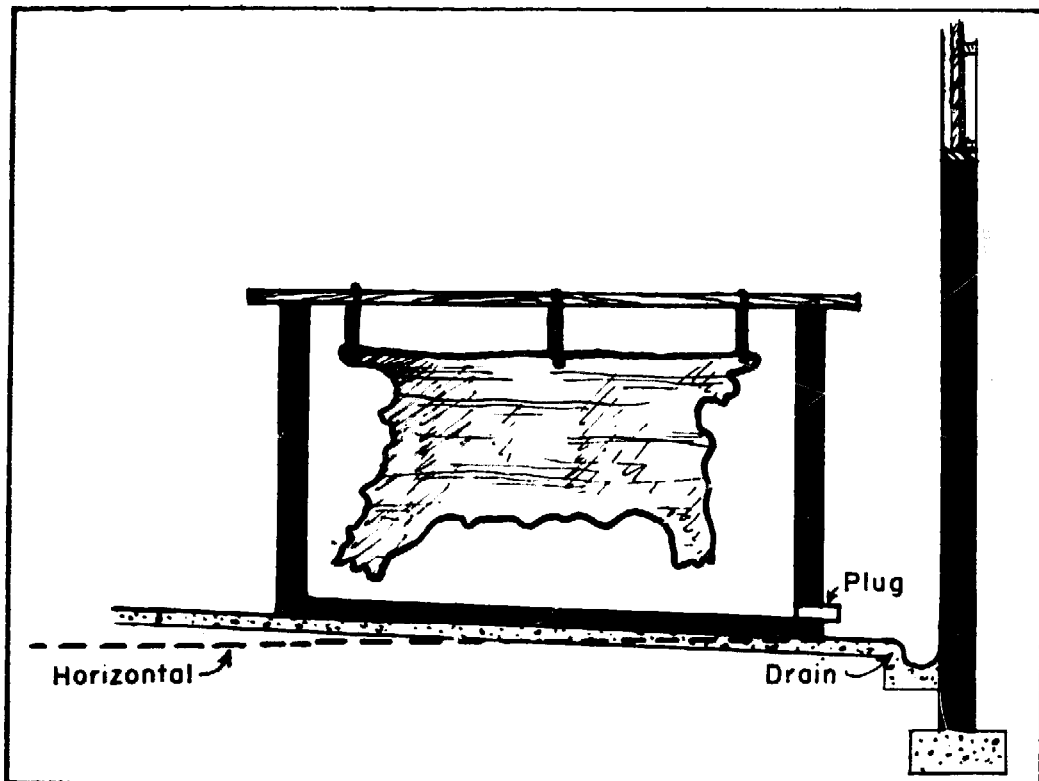

FIGURE 86. - *Moving hides in suspender pits.*

Courtesy Kenya Information Office, Nairobi

FIGURE 87. - *Cross section of vat showing sloping base (with slope expressly enlarged) toward drain. Side in vat is suspended from a wooden slat.*

Courtesy Mrs. Erica Mann



THE TANNERY PROPER

The part of the building where the hides or skins are tanned must be separate from the beamhouse. A clear space should always be left between the two, although a wall is not necessary.

The size of the tannery proper depends on the amount and on the nature of the material to be treated and also on the number of hides and skins to be taken for each soak. If only skins are to be tanned, the tannery need not be a large building. If, however, the tanner intends to handle cattle hides as well, the space must be much larger, and the following vats will be required:

Eight suspenders and handlers — each 1.5 meters long, 0.9 meter wide and 1.5 meters deep (Figures 86 and 87) — and three lay-away tanks of the same dimensions. There must also be enough space for leaching the bark.

The eight suspenders and handlers are interconnected by staggered drainways, which are about 15 centimeters in diameter, at the top of the dividing walls. These drains allow the tan liquor, which is always added to the last suspender, to overflow from vat to vat. They strengthen each vat in turn by an equal volume of mellow liquor, while an equal volume of used liquor is rejected from the first vat, either by overflowing or by draining. The diagram shows how the liquor moves in the opposite direction to the hides (Figure 88). The number of hides which enter the first vat is identical to the number which leaves the last. Thus a continuous and steady flow

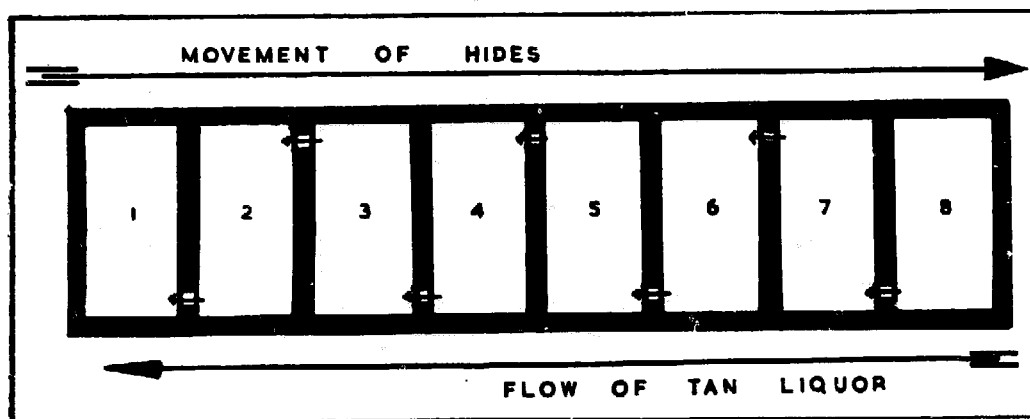

FIGURE 88. — Sketch showing that hides and tan liquor move in opposite directions and that the vats are interconnected.

Courtesy Mrs. Erica Mann



FIGURE 89. - *Interior of drying shed for leather.*
Courtesy Kenya Information Office, Nairobi

FIGURE 90. - *Leather displayed on "horses."*
Courtesy Kenya Information Office, Nairobi

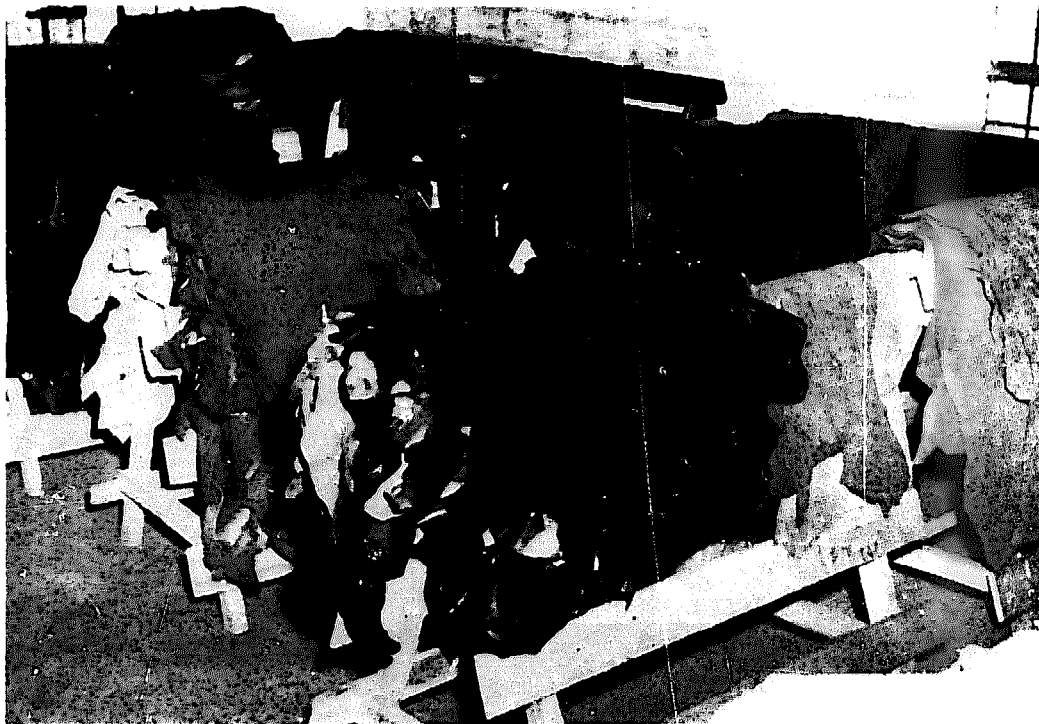

of goods is maintained. When tanning skins, it is better to install paddles, and not hand-driven drums.

One or two tables are needed for scouring, fatliquoring, oiling and stuffing. Each must be large enough to take a hide or skin stretched out completely without any of it hanging over the side.

DRYING SHED

The forced drying of leather under direct sun or in hot wind, as earlier chapters have stressed, is undesirable. Hence, every tanner must have a drying shed (Figure 89). This need not be an elaborate building, but it must protect the leather from rain, direct sunlight and heat. The drying shed can be a part of the main building. Any shed built of wood or adobe, however, will be adequate.

A leak-proof thatched or country-tiled roof is cheap, cool and satisfactory if sacking is stretched out below to prevent dust and other contaminating particles from falling on the hides. Corrugated iron becomes excessively hot under tropical conditions. If it is used, it should be covered with mats.

The sides of the sheds should be built in such a way that parts of it can be opened to increase circulation of the air. The beams of the roof should not be too high, and they should be provided with hooks made of brass or stainless steel, from which leather can be hung. As there is no effluent or other waste, this part of the tannery does not require a permanent floor.

FINISHING ROOM

Staking, dyeing, glazing, buffing and compressor and handrolling for sole leather and sorting are done in the finishing room. Here it is necessary to have shelves and cupboards for dyes and chemicals, as well as several tables and "horses" (Figure 90). It is also desirable to have a box — 1.2 meters long, 1.2 meters wide and 0.3 meter deep — for clean sawdust.

STORE FOR FINISHED LEATHER

Finished leather must be kept on racks in a well-ventilated and dry store. There should be a table on which leather can be spread for measuring. If sole leather is sold, a weighing scale will be necessary. This dry store should also be the tanner's office, where he keeps all his records, invoices and books, for it is the cleanest and driest part of the tannery.

Machinery

Throughout this paper mainly simple hand tools have been recommended. and, in the design for rural tanneries, no provision has been made for machinery. When, however, expansion occurs, when labor becomes more expensive and increased funds are available, a gradual replacement of manual labor by machinery may follow.

XIX. WATER

Water has a primary importance for tanneries. It is essential, therefore, to see that water is available in abundance and that it is also suitable for tanning. It may astonish the rural tanner to learn that water, though considered pure enough for him to drink, is not necessarily suitable for tanning.

A suitable water supply must be given the first consideration. An unsuitable, or insufficient, supply of water interferes with the production of leather in all basic processes. It affects the leaching, soaking, deliming, tanning, fat liquoring and dyeing, and it increases the cost of production by the loss of tannins and by the loss in hide substance. It is disastrous, therefore, to start a tannery before the availability and suitability of the water has been thoroughly tested. It is cheaper to bring all the tanning materials to suitable water rather than to bring the water to the tanning materials. The main conditions to avoid are: (a) hardness; (b) presence of iron; and (c) contamination with sewage, factory wastes, etc.

Hardness

For the purpose of this paper, water can be divided into two categories: hard water, which contains certain salts; and soft water, which is free of these salts.

In hard water, soap lathers with difficulty; but in soft water, it lathers easily.

The salts contained in hard water have a very bad effect on several tanning processes, and, as far as possible, only soft water should be used. Rain water or neutral stream water are the best.

Hardness, which is generally due to the presence of calcium and

magnesium salts, may be "temporary" — that is, it is removable by boiling. On the other hand, it may be "permanent" — that is, it is not removable by boiling.

A simple test can be made to determine whether water is soft or hard:

Two bowls or plates of equal size are required. Rain water is put into one, and the water to be tested is put in the other. With a piece of good toilet soap the hands are washed vigorously for half a minute in one bowl; and the washing is then repeated in the second bowl. If the amount of lather produced in both bowls is more or less the same, the water is soft enough to use. When, however, only a little lather is formed, this water is unsuitable for certain processes in tanning. Soft water, in contact with soap, feels smooth and soft, whereas hard water, in contact with soap, gives a harsh rough feeling.

To see whether the hardness is temporary or permanent, another simple test must be made. If, after boiling, hard water throws down a sediment, it may then lather; and, if so, the hardness was only temporary. Permanently hard water does not lose its hardness when it is boiled. None the less, temporary hard water is also unsuitable for a tannery because boiling all the water is out of the question.

Water can be softened by treatment with lime, lime and soda or by the addition of acids. Patent water softeners can also be used. All these installations are, however, too costly for the rural tanner.

In deliming by washing with water alone, temporary hardness and free carbon dioxide react with lime in the pelt. This forms a precipitate of calcium carbonate on the grain and flesh surfaces, and it is known as "lime blast." This deposit causes uneven bating, uneven coloring in the tan liquors, and dullness in glaze finishing. With hard water it is difficult, if not impossible, to make an emulsion for fat liquors; and certain dyes may not dissolve well in hard water.

Iron

Water may be undesirable for reasons other than hardness. Iron in water reacts with vegetable tannins and causes black or bluegreen stains on leather because tannin and iron produce an ink.

Iron may be present in water in the form of dissolved iron, or as "iron bacteria." These bacteria assimilate iron into their bodies; iron water pipes may be dissolved to obtain the necessary iron.

Iron can be removed from water by several processes. The cheapest process is lime treatment or aeration — that is, spraying water into the atmosphere. Although cheap and simple, aeration requires expert advice. Iron in water or iron stains on leather can be put out of action by acid sodium pyrophosphate, which is used in small amounts.

Whenever iron containers are used as storage tanks, they must be thoroughly coated with bituminous paint.

Contamination

Stagnant water, polluted by sewage and containing large amounts of decomposed organic matter, is most unsuitable for tanning; for the high bacterial content causes rapid putrefaction of hides and skins during soaking. Pollution of water with wastes from factories or with mineral oil or paraffin from storage tanks or garages may cause difficulties at every stage of tanning.

Abnormal amounts of mud interfere with many processes. Muddy water can be improved by settling and filtering.

Sources of water

RAIN WATER

Rain water is ideal for all tannery processes. In many areas however, the supply of rain water is unreliable. Wherever possible, the roof of a house, tannery or other building, should be used to collect rain water, which should be stored in underground cement tanks or else in corrugated iron tanks coated with bituminous paint. As impurities tend to settle, the draw-off tap should be at least 15 centimeters from the bottom of the tank. In some areas, rain water is collected in shallow pans built into rocks. As a rule, this water is suitable; but, again, it is rarely available in adequate quantities.

PONDS

The quality of water from ponds, lakes and other stagnant sources depends on such factors as the size and depth of the lake or pond, the proximity of settlements, and pollution with factory effluents. Before it is used, this water should be carefully tested.

RIVERS

Wide variations exist in the quality, not only from river to river, but also from point to point in the same river.

As a rule, water should be drawn from upstream of any large town to avoid factory or sewage pollution. Rivers may contain undesirable chemicals leached from the soil. This can happen when, for instance, they flow through limestone.

Mountain stream water is usually the finest river water; it is not polluted and it is as soft as rain water.

SPRINGS

Contrary to common belief, spring water is not always suitable for use in tanneries. It may be very hard or it may contain iron, sulphur, or other minerals which can interfere with the tanning.

WELLS

Frequently water from shallow wells is polluted. Deep well water is usually pure and it needs to be tested only for hardness and for iron.

Rural tanners cannot afford complex purification equipment. For this reason, they must be certain of the purity and abundance of the water supply, before they start a project which is so dependent upon suitable water.

A large co-operative tannery could perhaps afford a private deep well or draw its water from a tested township supply. If these two alternatives are impossible, the tannery could use water from a stagnant source — provided the water is soft and free from iron — by filtering out the suspended and decomposed organic matter.

Water can be filtered by passing it through sand. As a rule, this sort of filter is built as a rectangular brick or concrete tank. On the bottom a series of parallel channels support a layer of coarse gravel, on which the sand rests. The tank must be not less than 2.4 meters deep, so that drains and gravel may be 0.6 meter deep and the sand 0.9 meter deep. The remaining 0.9 meter holds the water awaiting filtration. The rate of flow must be adjusted, so that the amount coming in is equal to the amount flowing out. It is advisable to have two such sand filters, for periodically they become clogged and must be cleansed. Antiseptics, however, may also have to be applied when stagnant water is used.

So many factors influence the quality of water for tanning that a qualified person should be consulted before tanning is started in a new area. Where the water has already been used successfully for tanning, no further tests are necessary.

For testing, which must be done in a well-equipped laboratory, two liters of water should be sent for analysis in a clean bottle with a closely fitting stopper, which has been thoroughly rinsed in the water to be analyzed. When taking samples from a river or a well, the bottles should be immersed below the surface of the water with the stopper closed. The stopper is then removed, and the bottle is allowed to fill completely. The stopper should then be returned and fastened, and the bottle packed for dispatch to the laboratory.

It is now clear that the water problem must be solved before the site for the tannery is selected.

Effluents

A quantity of about 1,350 liters of water is required for each 50 kilograms of hides or skins to be tanned. Hence, every tannery has to dispose of large amounts of effluents which are heavily contaminated with tannins, lime and organic waste, such as hair, fleshings, fat, blood, dung and pieces of hide or skin. The organic material will decompose rapidly and produce very unpleasant odors. The hygienic disposal of effluents is as important as the availability of suitable water supplies.

It is most convenient to divert effluents directly into the sea, a large river or an existing sewer.

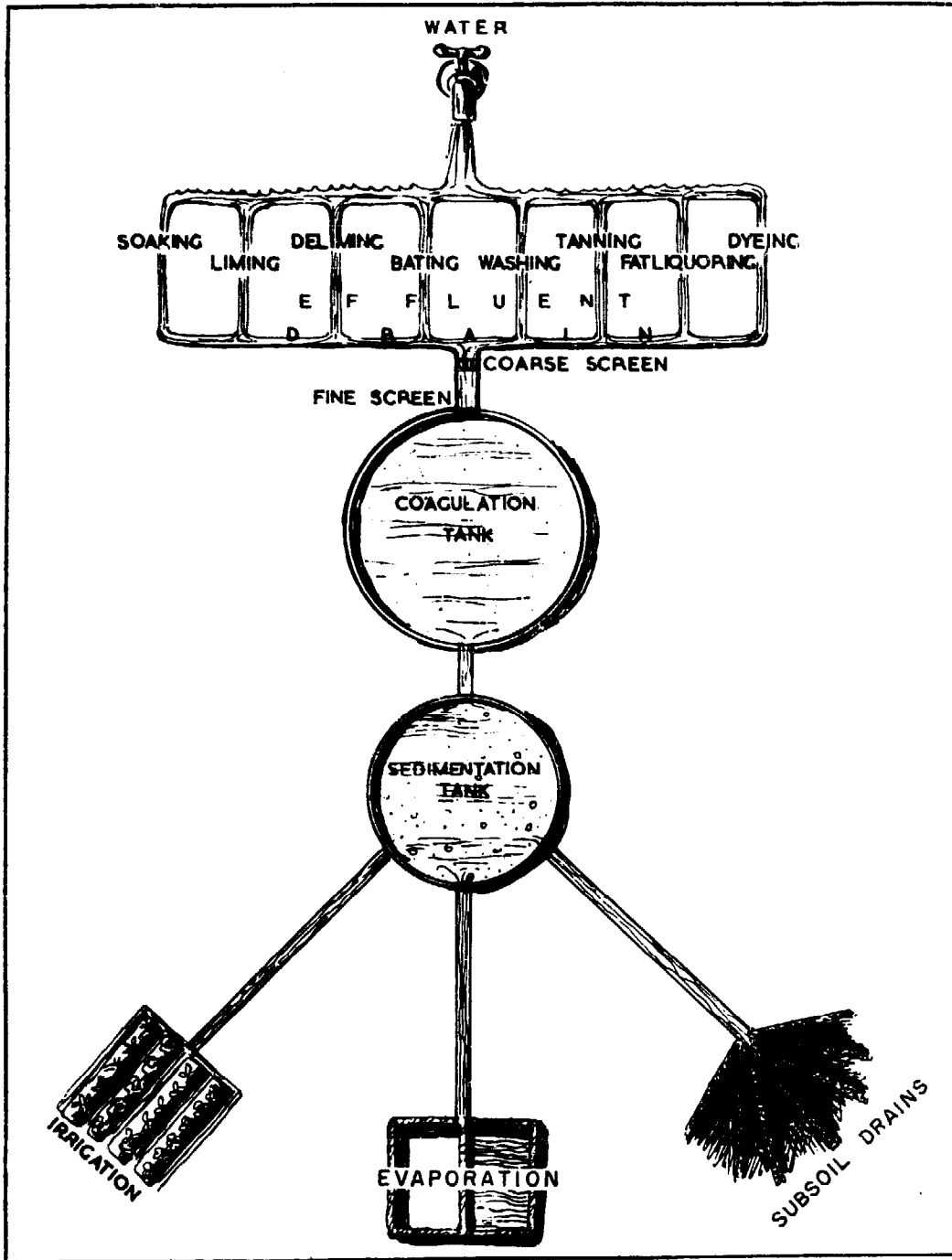

FIGURE 91. - Sketch of layout of drains, coagulation and sedimentation tanks, and three possible methods of disposing of effluents.

Courtesy Mrs. Erica Mann

In most countries public health legislation prohibits the discharge of unpurified factory effluents into rivers. Where there is no legislation concerning effluents, the tanner is still advised to be very careful about the disposal of sewage; it is unfair to pollute other people's drinking or washing water and thus to endanger their health.

Under rural conditions, tannery effluents should be eliminated as cheaply as possible. If sewers, rivers or the sea cannot be used, land treatment is a good alternative. This can be done in three ways (Figure 91):

1. Direct flooding of the land by small quantities of used water, which will be lost by evaporation and seepage. As a rule, alternate square beds surrounded by low earth ridges are flooded. This land should not incline more than 0.3 meter in 3 meters.
2. An excellent method, provided the nature of the soil permits it, is to divide the land into ridges, to plant the ridges with crops, and to discharge the effluent along the furrows. Thus the effluent irrigates and fertilizes the crops at the same time. This method gives the tanner an additional income and more than pays for the water which he uses in the tannery.
3. Another method of disposal in light, sandy soils is by subterranean drains. These should be 1.5 meters deep, 0.6 meter wide and filled in to about 15 centimeters below soil level with stones. The stones are then covered with grass or old corrugated iron sheets, and they are topped with soil. Alongside the trenches, eucalyptus (gum) trees can be planted to assist evaporation.

Before any of these methods are applied, the effluents must first be treated. In the first method any sludge in the effluent quickly clogs the pores in the soil, and seepage stops. In the second method, cultivation is rarely successful, because the plants are treated with tannins one day and with lime the next. In the third, the open spaces between the stones quickly become filled with sludge.

A good solution is to have the material precipitated in tanks, in which the tannins and lime are mixed and subsequently settled as sludge in sedimentation tanks. These should be built in pairs to facilitate cleaning.

The rural tanner need not be put off by the use of the word 'tank.' At first, simple, unlined pits can be used. Later, with the growth of the tannery, more permanent round or rectangular tanks of brick, stone or cement should replace them. The size of both precipitation and sedimentation tanks is directly dependent on the amount of effluent to be handled.

The sludge, consisting of wet solids, is formed at the bottom of the pits, and it must be removed periodically. The disposal of this sludge presents a problem. V-shaped trenches — 0.6 meter wide and 0.3 meter deep — can be dug; the wet sludge can be thrown into these and covered with earth. The rural tanner is better advised, however, to use the sludge to make compost for the land.

He can also use his compost heap to dispose of other tannery waste, such as hair, fleshings and trimmings, household and farm waste and animal manure or night soil.

The tanner should, in fact, start two compost heaps simultaneously, and each should measure about 7 square meters with a distance of approximately 4.8 meters between them. Bricks, stones and any other coarse material are placed on the ground to form a base for the compost heaps and to encourage aeration. Alternate layers of grass, straw, household waste, tannery sludge and offal are placed on top of this base until the heap is about 1.5 meters high. To assist decomposition, the heaps are covered with dry grass. After one month these two heaps are converted into one heap. In the second month, this compost heap can be turned over again. By the third month decomposition should be complete. At this stage the compost should be free from offensive odors and ready for use.

pH VALUE IN TANNING

In the preliminary tanning processes, such as soaking and liming, mainly *alkaline* solutions are used. Solutions of lime, sodium sulphide, caustic soda, ammonia, etc., in water are called *alkaline* solutions. Strongly alkaline solutions *dissolve* hide substance.

For deliming and actual tanning processes *acid* solutions are used. Solutions in water of oxalic acid, formic acid, acetic acid, hydrochloric acid, sulphuric acid, etc., have *acid* reactions. Strong acid solutions destroy hide, cloth and even metals.

In the past, in vegetable tanning processes, the acidity of the solutions was regulated by using raw vegetable materials. These contain sugars, which fermented naturally to produce the necessary acidity. Formerly tanning liquors were tested with the tongue to discover whether they were strongly or weakly acidic.

More exact methods of determining whether a solution is acid or alkaline are now in use, and they enable the modern tanner to regulate the actual tanning process properly. The degree of alkalinity or acidity is indicated by means of a figure which is called the "pH value" (the hydrogen ion exponent).

By definition, a neutral solution — that is, a solution which is neither acidic nor alkaline — has a pH value of 7.0; and pH values which decrease from 7.0 represent solutions of increasing acidity, while values which increase from 7.0 represent solutions of increasing alkalinity. The scale which is used is given schematically in Figure 92.

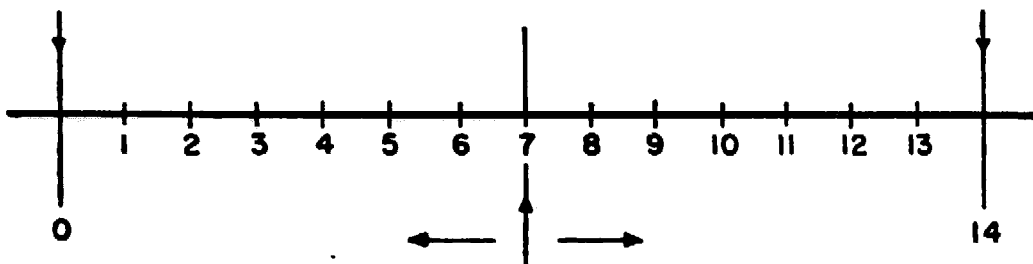

FIGURE 92. — Scale indicating the pH value of acid, neutral and alkaline solution.

To determine the pH value of a liquid, indicators are used; and this is the colorimetric method. On the other hand, modern chemical laboratories — those, for example, in large-scale tanneries — use what are called pH meters; and this is the electrometric method. As a rule, the practical tanner finds that indicators are accurate enough to measure the pH value. For this reason, a progressive rural tanner, while he is working in his tannery,

should always carry with him a booklet of indicator papers to test his solutions regularly. This method of measuring the pH is obviously more accurate with colorless liquids than with colored liquids.

Indicators are special substances, soluble in alcohol and/or water. These solutions change in color according to the pH value of any liquid into which they are introduced. Thus it is possible to use the color of the solution as a measure of its pH value.

An example is the use of phenol phthalein, which has been already described.

Papers soaked in these indicator solutions and dried out are sold in book form. They are very helpful for the practical tanner who wants to control his bate liquors, pickle liquors and other colorless solutions. Table 1 shows how the full range of pH values, as used in tannery processes, are covered by a variety of indicators.

TABLE 1. - RANGE OF pH VALUES FOR SOME INDICATORS

Name of indicator	pH range
Thymol blue	1.2 - 2.8
Brom phenol blue	3.0 - 4.6
Methylred	4.4 - 6.0
Brom cresol purple	5.2 - 6.8
Brom thymol blue	6.0 - 7.6
Phenol red	6.8 - 8.4
Cresol red	7.2 - 8.8
Thymol blue	8.0 - 9.6
Cresol phthalein	8.2 - 9.8

It is not necessary for the practical tanner to have all these indicators; for, as Table 2 shows, the approximate pH values of the main processes have a specific pH range.

A regular control of the pH value throughout all the processes, it should be realized, goes far to ensure good results.

The most important indicator papers for the practical tanner are "congo" and "delta" papers. Congo paper has a blue color at a pH value of 3.0, a blue-gray color at a pH value of 4.0, and it remains red at a pH value of 5.0. Delta paper undergoes the following changes in color:

pH 5.0	yellow
pH 6.0	grey yellow
pH 7.0 (neutral)	grey
pH 7.2	slight blue
pH 8.0	blue

Indicator *solutions* can be used to determine the pH of a solution. This is done by adding a few drops of the solution to a sample of the liquid in a test-tube and by observing the change of color. Pieces of pelt can also

TABLE 2. - APPROXIMATE pH VALUES OF A NUMBER OF TANNING PROCESSES

Process	pH value
Soaking (almost neutral)	5 - 7.5
Soaking (alkaline), if alkali is added to assist soaking	9 - 10
Liming (strongly alkaline)	approximately 12.5
Deliming and bating (almost neutral when at the end)	7.5 - 8.5
Vegetable tanning (moderate to weak acid)	3 - 5.5
Pickling (acid)	2 - 4
Chrome tanning	approximately 2 at the start, up to 4.5 towards the end

be tested by using suitable indicator solutions — for example, in the delimiting and bating process, by using phenol phthalein; and in the pickling process, by using congo red or methyl orange. Meanwhile, the neutralization of chrome leather can be followed by using brom cresol green, or brom cresol purple, or blue litmas, paper. Table 3 shows the particulars.

TABLE 3. - PROPERTIES OF A RANGE OF INDICATORS

Name of indicator	Color change		pH range applicable
	From	To	
Congo red	blue	red	3.0 - 5.2
Brom phenol blue	yellow	blue	3.0 - 4.6
Brom cresol green	yellow	blue	3.8 - 5.4
Brom cresol purple	yellow	purple	5.2 - 6.8
Phenol phthalein	colorless	red	8.2 - 9.8

There are many more indicators in regular use, but, as a rule, the practical tanner is satisfied with the ones already mentioned. The indicators can be easily bought, either as dry powders or as solutions already prepared for tannery use.

Through suitable mixtures of certain indicators, the color change can extend over a large portion of the pH range. These mixtures are usually called *universal indicators*. One example is the B. D. H. universal indicator. The color changes are: pH up to 3, yellowish green; pH 4, orange-red; pH 5, orange; pH 6, yellow; pH 7, yellowish green; pH 8, greenish blue; pH 9, blue; pH 10, violet; and pH 11, reddish violet.

TANNERY RECORDS

The only way to control the production, to ensure better quality and to make a profit is to keep records. Leather of high quality is the aim of every tanner, but it is only too easy to forget what kind of chemicals were used, the time needed for different processes and even the quality of the raw material which has been obtained. It is essential, therefore, for a good tanner to keep adequate records.

The record sheet should be pinned on a wooden board, and it should remain adjacent to the hides or skins to which it refers as they move from vat to vat. Details of every stage of production which have any bearing on the hides or skins should be entered on the record sheet.

The hides or skins must be marked in relation to the record sheet. Paint or pencil marks are unsatisfactory, for they will be lost during the various processes, or they will produce stains. The use of an 0.5 to 1 centimeter punch permits a whole range of code marks; one, two or three holes in a row; one above the other; triangles; squares and so on. The marks should always be punched in the same place — for example, on the right fore shank — so that they can be found at a glance. It is actually preferable, however, to mark the hides on both sides of the root of the tail.

The interpretation of these records will give the tanner much experience and will prevent him from repeating mistakes.

Table 4 shows a useful example of a tanning record.

TABLE 4. - EXAMPLE OF A TANNING RECORD

REMARKS AND OBSERVATIONS	
STARTING DATE	BATCH NO. MARKING
TYPE (Goat, sheep, calf, cattle, buffalo, etc.)	
TOTAL NUMBER	
WEIGHT	(a) Raw hide (b) Soaked weight (c) Limed weight (d) Pelt weight (e) Wet-leather weight (f) Shaved leather weight (g) Finished leather weight or area.

	PROCESSING TIME	QUANTITY OF CHEMICALS USED
SOAKING	From To	
LIMING	From To	
BATING	From To	
Remarks and Observations		
DRENCHING	From To	
Remarks and Observations		
 OILING, TANNING, FAT LIQUORING OR STUFFING		
	From To	
Remarks and Observations		
DRYING	From To	
Remarks and Observations		
FINISHING OPERATION (Dyeing, fat liquoring, setting, drying, staking, pigment finishing, glazing and ironing)		
FINISHING DATE		
QUALITY REPORT (Area or weight)		
Date	Signature	

Appendix 3

CONVERSION RULES

To convert:

Centimeters to inches
Meters to feet
Square centimeters to square inches
Square meter to square feet
Cubic centimeters to cubic inches
Cubic meters to cubic feet
Liters to cubic inches
Liters to U.S.A. gallons
Liters to Imperial gallons
Grams to pounds
Kilograms to pounds

Multiply by:

0.3937
3.281
0.1550
10.76
0.06103
35.32
61.03
0.2642
0.2203
0.002205
2.205

Centigrade to Fahrenheit

°C	°F
0	32
5	41
10	50
15	59
20	68
21.1	70
25	77
26.7	80
29	84.2
30	86
32.2	90
35	95
37.8	100
40	104
43	109.4
45	113
50	122
60	140
70	158.9
74	165.2
100	212

GLOSSARY

This glossary is compiled from a series of articles entitled "Encyclopaedia of the Leather Trade," by D. Woodroffe which appear regularly in *The Leather Trades' Review*; John Arthur Wilson's *Modern Practice in Leather Manufacture* and the *Glossary of Leather Terms*, British Standard 2780; 1956, published by the British Standards Institution.

ALUM TANNED LEATHER

Leather prepared solely with a mixture of which the essential active ingredient is an aluminium salt. This is often, but not necessarily, alum — for example, alum, salt, egg yolk and flour. The natural color of the leather is white.

ANILINE DYED

Leather which has been dyed by immersion in a dyebath and has not received any coating of pigmented finish.

ASTRINGENCY

This refers to the property of many vegetable tannins in bringing about a contraction, or drawing together, of the pelt fibers, and it varies in its intensity with different materials. Astringency appears to be associated with a high tan to nontan ratio, low acid content and very low salt content of the liquor; for an alteration in any of these factors affects the result. *Mellowness* in a liquor is the reserve, and it refers to one in which the combination rate with hide substance is slow and the penetration rapid.

BABY CALF

Calf skin leather made from small, lightweight skins with a smooth or finely boarded grain surface, free from any artificial surface pattern. The finish is more or less glossy, and it is produced by glazing, ironing or plating.

BACK

The main portion of a hide, obtained by cutting off the two bellies (see Figure 18).

- BAG HIDE** Flexible leather generally embossed with a grain pattern; oat grain is the most usual. Made from cattle hide, usually vegetable tanned, split to a suitable thickness and sometimes hand or machine boarded.
- BARKOMETER** An instrument used for measuring the density ("strength") of tan liquors. In the barkometer scale, one degree specific gravity is divided into 1000 equal subdivisions. Each of these divisions is called a barkometer degree, and it is expressed as X° Bkr. To convert barkometer degree into specific gravity, the former is divided by 1000 and 1 added to the quotient.

$$\text{Specific gravity} = \frac{\text{Degree Barkometer}}{1000} + 1.$$
 Conversely degrees barkometer = (specific gravity - 1) × 1000.
- BARK TANNED** Leather vegetable tanned by means of the tannins contained in the barks of trees. In the process the leather comes in contact with the raw bark.
- BATE** Materials which are used for the removal of nonessential proteins like globular, mucins, elastins and residues of keratin by chemically reacting with them and dissolving, along with some fats. They also remove lime from hides and skins. Formerly hen, pigeon and dog dung were used. With dog dung the process was known as puering. Nowadays artificial bates which contain proteolytic and lipatatic enzymes and deliming chemicals are manufactured. These are quite as efficient as dung bate, and they are not obnoxious. Bating renders the final leather soft and supple to the feel and silky on the surface.
- BATING** To treat skins with a commercially prepared bate or a bate made from animal pancreas and ammonium chloride.
- BEAM** An inclined table with a convex working surface. Used for fleshing, unhairing and scudding.
- BEAMHOUSE (WETHOUSE)** Part of tannery where hides and skins are soaked, limed, unhaired, scudded, bated and drenched. It is that part of the tannery where hides and skins are prepared for the actual tanning.

BELLY	That portion of a hide or skin which covers the underpart of an animal and includes the upper part of the legs (see Figure 18 and OFFAL).
BELLY GRAIN	The tanned outer, hair or grain side split from a belly.
BELLY MIDDLE	The middle part of a cattle hide belly (see Figure 19).
BELTING BUTT	The butt portion of selected cattle hides which have been specially tanned, curried and dressed to produce strong, flexible leather with minimum stretch, suitable for the manufacture of machine belting.
BEND	Half of a cattle hide butt, obtained by dividing it along the line of the back bone. Usually applied only to tanned material (see Figure 18).
BLEACHING LEATHER	For vegetable-tanned leathers this usually consists of making the color lighter by washing and thus removing the oxidized tannins and insoluble matter from the surface with a solution of soda ash, and then by treating with diluted acid, or by using bisulfited tanning or bleaching extracts. Synthetic tanning materials are also used for this purpose. For chrome-tanned leather it usually consists of making the color lighter by treatment with syntans and sometimes also by precipitating white pigments on the surface of the leather to give it a white appearance.
BOARDED LEATHER	Leather which has been softened and its surface lightly creased by folding, grain to grain, and then by working the fold across the leather to and fro by means of hand boarding or a boarding machine.
BOX CALF	Black calf skin leather with a surface pattern of fine box shaped creases formed by boarding the skin in two directions — neck to tail and belly to belly. Full-chrome tanned.
BOX SIDES	Black leather dressed in the same way as box calf, but made from cattle hides cut down the backbone. The tannage may be full-chrome, semichrome or vegetable.

BRAN DRENCH

A warm infusion of bran, in which the puered or bated skins are immersed. The bran contains starch which is converted into organic acids and gases in the skin. The gases, separate the pelt fibers, inflate the pelt and cause it to rise to the surface of the drench liquor; the acids complete the delimiting of the pelt, bring about slight acid swelling and effectively check further bating action by acidification. The bran particles help to scour the pelt and remove the scud, leaving the pelt white and clean.

BRIDLE LEATHER

Strong flexible leather of reasonably uniform thickness with a plain finish and a close shaved flesh. Made from ox or cow hide, vegetable tanned and curried.

BUFF LEATHER

Flexible dry leather with a cream or white surface and finished on the grain side with a velvet-like nap. Made from cattle hides, from which the whole of the grain has been removed, and oil tanned.

BUFFALO

Leather made from the hides of buffalo cattle, excluding the North American buffalo.

BUFFED LEATHER

Leather from which the top surface of the grain has been removed by an abrasive or bladed cylinder or, less generally, by hand. With upholstery leather known as "hand buffed," the buffing process is invariably carried out by means of an abrasive or bladed cylinder.

BUTT

That part of the hide which is left after the bellies and shoulder have been removed (see Figure 18).

BUTT SPLIT

The underlayer split from the butt of a cattle hide.

CALF

In its widest sense, this is leather made from the skins of young or immature bovine animals. In a more limited sense, it is leather made from the skins of those animals of the bovine species which had not been weaned or had only been fed upon milk and which do not exceed a certain weight in the green state; this limit may be 6.8 kilograms, or even higher. The heavier skins of immature milk-fed animals up to 11.3 to 13.6 kilograms in green weight are often termed veals.

CASE HIDE

The skin of a fully grown animal of the bovine species.

CHAMOIS

(a) Suede-finished leather made from the flesh of sheep- or lambskins, or from sheep- or lambskins from which the grain has been removed by frizzing. It is tanned by processes involving the oxidation of fish or marine animal oils in the skins. They make use either of these oils solely (full oil chamois) or, first, formaldehyde and then these oils (combination chamois). The U.S. Federal Trade Commission restricts the term "chamois," without any qualifications, to the flesh splits of sheepskins tanned solely with oils.

(b) Leather made from the mountain antelope or chamois. This leather is rare.

CHEEK

Leather from the cheeks of cattle hides.

CHROME RETAN

Leather which has been, first, chrome tanned throughout its thickness and, second, further treated or tanned with vegetable and/or synthetic tanning agents. These retanning agents penetrate markedly, but not necessarily completely, into the interior.

CHROME TANNED

Leather tanned either solely with chromium salts or with chromium salts, together with quite small amounts of some other tanning agent. This other tanning agent is used merely to assist the chrome tanning process, and not in sufficient amount to alter the essential chrome character of the leather.

CIRCULATORS

Circulators, or a circulator round, consist of a series of tan pits which are interconnected. The leathers, or partly tanned butts, are suspended in these pits. As a rule, there are seven pits in a round, and butts are suspended in six of the pits, leaving one to contain tan liquor only. The butts remain suspended in the pits, and the tan liquor is circulated through all seven pits. Additions of extract, acid or salts are made to the liquor in the spare pit — that is, the one in which no leather is suspended. The temperature of the whole tan liquor in the circulator round can be adjusted by controlling that of the tan liquor in the spare pit. The advantages are: (i) Frequent handling before strengthening and adjusting the liquors is avoided; there is less hauling of the leather; thus labor is saved and labor

costs are reduced. (ii) The tannin penetrates more rapidly. (iii) There are no hook scratches caused by too frequent handling of the leather.

COMBINATION OIL

A tannage, or a process of tannage, in which the skin is first tanned with formaldehyde and subsequently treated by the oil process (see CHAMOIS).

COMBINATION TANNED

Leather tanned by two or more tanning agents — for example, chrome followed by vegetable (chrome retan); vegetable followed by chrome (semichrome); formaldehyde followed by oil (see COMBINATION OIL).

CORRECTED GRAIN

Leather from which the surface of the grain has been partially removed by buffing to a depth governed by the condition of the raw material. Upon this leather, a new surface has been built by various finishes (see BUFFED LEATHER).

COW HIDE

Strictly, this is leather made from unsplit cow hides or their grain split, but the term is sometimes applied to similar leathers from any hides of the bovine species. The term must not be applied to leathers from flesh splits.

CURRIED LEATHER

Leather which has been subjected to the currying process.

CURRYING

A series of dressing and finishing processes which are applied to leather after tanning. During these processes appropriate amounts of oils and greases are incorporated in the leather to give it increased tensile strength, flexibility and water-resisting properties.

DELIMING

The partial or complete removal of the lime or other alkali from lime pelts, by immersion in water, a weak solution of an acid or an acid salt. Not more than 60 percent of the lime can be removed by prolonged washing of the pelts in running water only. The remainder of the lime is chemically combined with the pelt and can only be removed by treatment with an acid or an acid salt. Hydrochloric, lactic, boric and acetic acid and sodium bisulphite or ammonium salts are commonly used. Treatment with acids can be dangerous due to the phenomenon called acid or overswelling, especially if

strong acids, such as hydrochloric or sulphuric, are used. To avoid this and to economize in the use of boric acid, it has become a common practice to delime the surface of pelts or butts with a mixture of borax and sulphuric acid. A pit is filled with a 0.25 percent solution of borax; the limed butts are suspended in this, and diluted sulphuric acid is added from time to time until the grain surface has been completely delimed.

DRAWN GRAIN

A grain showing an irregular pattern of creases or narrow grooves. It is produced by tanning the skin so that the main thickness has contracted relatively to the grain layer, which is then fixed in a puckered or "drawn together" condition.

DRENCH

Fermented bran or flour used for deliming skins.

DRENCHING

Soaking skins in a fermented infusion of bran or flour and warm water.

DRESSING HIDE

Unsplit rough tanned cattle hide, vegetable tanned in a manner giving good tensile strength and mellow feel. Suitable for dressing for harness and straps.

DUBBIN

Stuffing material used for heavy leather. This is usually a mixture of fish oil (preferably cod oil) and tallow in suitable proportion.

DYES (1) ARTIFICIAL

Dyes prepared synthetically.

DYES (2) NATURAL

Coloring matters of natural origin.

E. I.

An abbreviation of East India. A descriptive term applied to crust, vegetable-tanned cowhide (kip), buffalo hide and calf, sheep and goatskin, originating in the Indian subcontinent and tanned in India, mainly in the south, and especially around Madras (see KIP).

EMBOSSED LEATHER

Leather embossed or printed with a raised pattern, either imitating or resembling the grain pattern of some animal or being quite unrelated to a natural grain pattern.

EMULSIFYING AGENT

A substance which helps to form an emulsion.

EMULSION	A suspension of tiny droplets of fat in a liquid in which it is not soluble.
ENZYMES	An enzyme is a soluble, colloidal, organic catalyst, produced by a living organism. They are not themselves alive. When present, they can increase the speed of certain specific reactions without being affected themselves; only very small amounts are required to bring about these changes. The most important enzyme encountered in leather manufacture is trypsin, which is the active principle in the dog dung bacteria responsible for puering action. Trypsin also occurs in certain plants and moulds. Another source of trypsin is cattle and pig pancreas, which contains some other enzymes besides trypsin. Trypsin is the chief ingredient of tryptic bates, which are enzyme bating materials. Trypsin is also the active principle in the enzyme unhairing process. Epidermis is digested by trypsin. An enzyme papain has also been used for bating purposes. Puering and bating bacteria are effective owing to the enzymes which they form and contain. Enzymes are poisoned by some products but stimulated by others — for example, by ammonium salts. Enzymes are destroyed by heat.
FACE	Leather made from the face of cattle hide — that is, a triangular-shaped portion from between the ears and eyes to the nose, excluding the cheek (see Figure 18).
FALL (OR FALLEN)	To deplete or to remove the swelling of limed pelts. It is one of the effects of puering or bating. The bated pelts are soft, silky on the grain and flaccid. This is the condition known as "fallen," and the production of this effect is termed "to fall."
FAT LIQUOR	Is an emulsion of oil or fat in water, and the oil or fat globules in the emulsion are absorbed evenly by leather which is treated with it. The fibers of the leather become coated with the oil or fat, so that the leather is thereby rendered soft.
FAT LIQUORING	The process of applying emulsified fat to light leather.
FINISHING	All operations, such as oiling, dyeing and rolling, which are meant to improve the quality and appearance of the leather.

FULL CHROME (TANNED)	The adjective "full" is sometimes added to chrome tanned to emphasize the fact that the leather is neither semichrome nor combination chrome.
FULL GRAIN	Leather bearing the original grain surface, as exposed by removal of the epidermis, and with none of the surface removed by buffing, snuffing or splitting (see CORRECTED GRAIN).
FUR	The skin of a recognized fur-bearing animal dressed and finished with the hair on.
GLAZING	The operation of producing a bright, glossy or glass-like finish on the grain surface of leather by subjecting it to the action of a machine which rapidly draws, under pressure, a tool of glass, agate or other suitable material across the suitably prepared surface of the leather.
GRAIN	(a) The outer, or hair side, layer of a hide or skin which has been split into two or more layers. (b) The pattern visible on the outer surface of a hide or skin after the hair or wool has been removed.
GRAIN LAYER	The portion of a hide or skin extending from the surface exposed by removal of the hair or wool and epidermis down to about the level of the hair or wool roots.
GRAIN LEATHER	Leather which has the grain layer substantially intact and finished on the grain side.
GRAIN SPLIT	The outer, wool or hair side, layer of a hide or skin which has been split into two or more layers.
HANDLER	The vegetable tanning process for sole leather consisted of suspender liquors, handler liquors and layers. The first development of modern sole leather tannage includes these same three types of liquors. The handlers or handler liquors comprised those tan liquors which followed the suspender liquors. The handler liquors are stronger than the suspender liquors, and they vary between 15 to 45 degrees Barkometer strength. The butts were hung or suspended in the suspender liquors, but they were laid flat in the handler liquors. On alternate days, the butts were hauled, and piled to allow for

the strengthening of the liquors with extracts or stronger tan liquor. These liquors derived their name from this frequent handling. Nowadays, the handlers have been replaced in modern tanneries by rotors in which the butts are enclosed in a lattice drum, which is half immersed in the pit (see also LATTICE DRUM), or by circulators.

- HERSE** A wooden frame used for stretching skins for parchment or vellum manufacture.
- HORSE** A portable wooden vehicle on which leather, hides and skins are piled for draining or for transporting from one department to another.
- HOT PITS** A series of circulator pits in which very strong tannin extract liquors of about 130 degrees Barkometer are used at 41°C. to 43°C. The leather remains in these liquors for up to one week. It becomes filled with the strong extract liquor, and even crude quebracho extract liquors can be used because of the temperature. They are used to increase the amount of tannin fixed by the leather and also to fill the butts. The hot liquors are contained in a set of circulator pits. These comprise six pits in which the leather is suspended and one pit which contains tanning extract liquor only. This one pit is provided with a closed steam coil for maintaining the temperature. All seven pits are interconnected, so that by controlling the strength, temperature and pH value of the liquor in the seventh pit, these properties are also controlled for all the tan liquors.
- HYDRAULIC LEATHER** Leather made from cattle hide which has been so dressed with soft grease that it becomes virtually waterproof.
- HYPODERMIS** Loose connective tissue mixed with fatty tissue, joining the skin to the body.
- INDICATORS** Substances soluble in alcohol and water which undergo a change in color according to the pH value of any solution into which they are introduced, thus making it possible to use the color of the solution as a measure of its pH value. These indicator solutions can be used to control the pH value of bate liquors, pickle liquors and other colorless solutions.

INSOLE BELLY

Vegetable-tanned hide belly, suitable for insoles for footwear.

KERATIN

The basic substance (proteins) in all horny structures such as the epidermis, hair, nails, horns, claws. They are characterized by great resistance to fermentation (enzymes) acids and alkalies. They are extremely sensitive to reducing agents — for example, sodium sulphide and hydrosulphide — for they are speedily disintegrated by them. Hair is completely dissolved after one hour in a 10 percent solution of sodium sulphide. They are only slightly swollen by acids or alkalies. Thus if any epidermis is left adhering to the pelt after unhairing, it impedes the swelling and plumping of the pelt collagen, and this causes the production of thin, flat leather.

KICKER

Receptacle apparatus used for fur skins processing. Fur skins are pickled and rubbed on the pelt side with cod oil or similar fish oil. They are hung up in a warm drying room to oxidize and dry. The dry pelts are softened in the "kicker," which is a box-like receptacle containing sawdust. Into this box dips a foot-like projection which is capable of being moved to and fro mechanically, whereby any dry pelts can be softened. The movement of the fur skin in the sawdust cleans the hair and gives it a polish.

KILLING

A process applied to wool or fur skins in order to make dyeing of the wool or fur more easy. Killing is often done with soda ash (sodium carbonate), ammonia or ammonia and hydrogen peroxide.

KIP

Smaller type of cattle hide. They are:

(a) Hides of fully mature cattle, other than buffaloes, native to the Indian subcontinent; for these are smaller than those of Europe and America.

(b) Hides derived from immature European and American animals of the bovine species which have been grass fed and have sizes intermediate between those of calf and full grown cattle.

(c) As an abbreviation of the full term "East India Tanned Kip" — or "E. I. Kip" — crust, vegetable-tanned leather, made from cow or buffalo hide originating in the Indian subcontinent and tanned in India, mainly in the south and especially around Madras.

KISS SPOT

A light stain or lightly colored portion on vegetable tanned hides or skins caused by the pelts touching each other in the early stages of the tanning process. Movement of pelts in the first tan liquors is designed to avoid this staining. Staining may occur above the kiss mark through the settlement of heavy particles in the tan liquor on to the two grain surfaces. The kiss itself is not a discoloration; for it is the portion which touching has prevented from being colored.

KNEE STAKER

A metal blade set upright on a wooden support, which may be a rigid upright portion of the stand or an upright stake. The skins for staking are worked over the blade. Both hands and knee are used for giving the necessary pressure on the skin. Staking pulls apart the fibers of the skin, which should remain quite soft on drying out.

LATTICE DRUM

Lattice drums are usually designed to rotate in a pit. For washing only, lattice *doors* are used in an ordinary drum. Rotors are lattice drums with the butts fixed to slats inside.

**LAYAWAYS, LAYERS OR
LAYER VATS**

A vat containing relatively strong vegetable tan liquor into which sole leather hides are layed flat after preliminary initial tanning in pits or rocker vats.

LAYING AWAY

Storing hides in layer vats for a long time to ensure that they are tanned through; where only weak liquors are available, the hides are dusted with ground raw vegetable-tanning materials to provide a sufficient amount of tannin.

LEACHING

Extracting the tannins from the tannin-bearing material by immersion in water.

LEATHER

A general term for hide or skin, which still retains its original fibrous structure more or less intact, but from which the hair or wool may, or may not, have been removed and which has been treated so as not to be putrescible, even after treatment with water. Certain skins, similarly treated, or dressed, without removal of the hair are termed "fur." No product can be described as leather if its manufacture involves breaking down the original skin structure into fibers, powder or other fragments by chemical and/or mechanical methods and reconstituting these fragments into sheets or other forms.

LIME, FRESH	Slacked lime freshly dissolved in water.
LIME, MELLOW	Fresh lime in which some hides have already been limed.
LIME, OLD	Lime used many times.
LIME, CALCIUM OXIDE, BURNT LIME	Is produced by "burning" limestone or calcium carbonate. By this process carbon dioxide is driven off, and the burnt lime or calcium oxide remains. It is usually in the form of white lumps, which react violently with water to form slacked lime or calcium hydroxide.
LIME LIQUOR, LIMING	As slacked lime is very slightly soluble in water, excess gives a milky liquor — usually called a lime liquor — in which the raw hides are immersed to loosen the hair or wool and to swell and plump the collagen fibers of the pelt. Lime liquors also exercise a degree of saponification of the grease in the pelts and loosen some of the "scud" or undesirable ingredients in the pelt.
LIME PAINT	Sodium sulphide solution is mixed with slacked lime, hydrated lime or china clay to form a thin paint which can be applied to the flesh side of sheep, goat or calf skins. Alternatively, one can slake a mixture of burnt lime and red arsenic to yield a paint. The mixtures are so called because they are usually "painted" on the flesh side of the hide or skin. After treatment, the skins are folded down the backbone, or they can be placed, flesh to flesh, in pairs and left overnight. As a rule, the hair or wool is loose next morning and it can be pushed off.
MELLOWNESS	See ASTRINGENCY .
MORDANT	See STRIKER .
MUCILAGE	A soft jelly-like material, such as linseed mucilage, which is obtained by soaking whole linseed in water overnight. Next morning, the water is raised to the boil, simmered for a few minutes and allowed to cool; and the coarse particles strained off through coarse muslin. The thin jelly obtained forms the basis of many "binders" for use in finishing leather. Gum tragacanth and many other substances also yield mucilages.

NONTANS

Substances present in a tanning liquor which do not tan, such as sugary matter, gallic acid, soluble mineral salts and other acids.

OAK BARK TANNED

Leather conforming to the minimum requirements of the Oak Bark Tanners' Association Ltd. — that is, an unadulterated, unbleached leather, pit tanned for not less than five to six months by a process which embodies layering for not less than three months and employs oak bark as a basis of tannage.

OFFAL

The bellies, shoulders and head portions of cattle hide, which are cut away to isolate the butt (see Figure 18).

OILING OFF

Black chrome leathers, in particular, are sometimes "oiled off" — that is, they are given a light coat of mineral oil on the grain side before they are hung up for drying. The oil prevents the grain of the leather from becoming too hard and bone dry. As a rule, warm light mineral oil is employed, but other oils can also be applied. Sole leather is also oiled off for a soft grain and to prevent the vegetable tanning materials from drying on the surface.

OIL TANNING

A process of tanning which involves the incorporation of fish or marine animal oils into prepared skins. These oils are subsequently induced to undergo oxidation and other chemical changes in contact with the skin fibers, leading to chemical combination of oil derivatives with the skin.

PANCREATIN

Any enzyme product occurring in the pancreatic glands of mammals. Cattle and pig pancreas is the largest source; the pancreas is dried, ground to powder and then added to ammonium chloride and wood flour to give a substitute bating product. Pancreatin contains enzymes, the chief of which for the leather trade is trypsin, a proteolytic enzyme which functions best at pH 8.5 and 35°C. Substitute bates containing pancreatin are often described as "pancreatic" bates, and they have proved entirely satisfactory in bating hides, calf skins and sheep pelts.

PARCHMENT

Translucent or opaque material with a smooth surface, suitable for writing, bookbinding and other purposes, made from the flesh split of

sheep, goat or ass skin, by drying out the limed material without applying any tannage; the material is thoroughly cleansed and degreased and smoothed during the process. As a rule, parchment refers to the flesh split of a sheep skin.

PASTING OR PAINTING

The application to the flesh side of raw hides and skins of a lime paint, a mixture of slaked lime, water and sodium or arsenic sulphide or sodium hydrosulphide. The term "pasting" is applied also in drying dyed and fatliquored leather over glass or other suitable plates in the drying chamber.

PELT

In the leather trade, as opposed to the fur trade, pelt commonly means the hide and skin prepared for tanning by the hair or wool, epidermis and flesh.

PHENOL PHTHALEIN

A white powder soluble in ethyl alcohol, used as an indicator. Its range of color change is from the pH value 8.3 (colorless) to pH value 10.0 (deep pink, red). It is useful in indicating the extent of the delimiting of limed pelts. A drop of phenol phthalein in a 1 percent solution applied to the cut edge of a partly delimed pelt indicates the presence of lime by a deep pink color (see also PH VALUE).

PH VALUE

A measure of the strength of the acid or alkaline reaction of a solution, where 7.0 represents a neutral solution. Values decreasing from 7.0 represent solutions of increasing acidity and values increasing from 7.0 represent solutions of increasing alkalinity.

PICKLING

The treatment of bated skins or drenched skins with a solution of salt and acid (sulphuric, hydrochloric or formic) to preserve them, or as a preparation for the tanning operation. Pickling increases the rate of penetration of the tanning so as to prevent drawn grain. Pickling brings the pelt to a nonswollen acid condition which is very necessary as a preliminary to chrome tannage; commonly used before chrome tanning, but not generally in vegetable tanning.

PIGMENT FINISHED

Leather to the surface of which a finish containing fine pigment particles in suspension has been applied. Sometimes called "doped."

PIT LIMING

A method in which hides and skins are limed in rectangular brick or concrete pits, varying in size, according to the class of goods to be processed. The smaller pits are used for skins, the larger pits for liming hides. The pits may be sunk from ground level, or they may be built above ground. The raw hides and skins are immersed in lime liquor in the pits for three days. Then the liquor may be strengthened with freshly slaked lime paste (one-pit system) or the goods may be transferred to a pit containing a once-used lime liquor. After a further three days, the goods are transferred to a new lime liquor prepared in the same pit (one-pit system) or to a fresh pit containing a new lime liquor (three-pit system). The pits must be provided with waste exits, or the liquor must be removed by pumping it out of the pits. Pit liming is laborious because the goods must be frequently hauled from the pits to permit the plunging of the liquor in them; for this is necessary to agitate the lime sediment and so to maintain the saturation of the lime liquor. Mechanical devices have been designed for agitating pit lime liquors.

PUERING

The treatment of fleshed, limed pelts or grains with a warm infusion of dog dung for 1½ to 5 hours, according to the type of pelt, in order to remove traces of epidermis tissue, short hairs, lime soaps and "cementing substance," to loosen the scud, to deplete the pelts and to complete the deliming, and to increase the stretch and pliability of the finished leather.

PULLING

A term applied to the removal of the wool loosened in fellmongering. The wool is actually pushed off by hand and sorted as it is removed. The operators are called "pullers."

RAWHIDE BELTING LEATHER

A leather suitable for the manufacture of high-speed machine belting. It is made from dehaired and fleshed cattle hide by treating it, either as such or after alum tawing (tanning), with vegetable tanning agents so as to leave a central layer untanned. The product is subsequently curried.

REIM LEATHER

A kind of leather for the strap of a bridle obtained from oil-tanned hides.

ROTORS

See LATTICE DRUM.

ROUGH TANNED LEATHER	Leather, usually vegetable tanned, which has not been further processed after tanning, but has been merely dried out. The term "rough tanned" is used chiefly in relation to hide leather — for example, tanned strap butts.
ROUNDING	Trimming and cutting the hide into different parts according to the quality and the use to which the leather is to be put.
SAMM (SAMMY)	When wet leather is allowed to dry, it passes through a stage at which it is still damp, but no water can be squeezed out. At this stage, the leather is said to be in a sammed condition. The process of producing this condition in the leather is described as "samming" or "sammying." Sammed leather is in an ideal condition for absorbing grease or fat liquor. Most leather is sammed before it is treated with grease. "Sammed" is, in fact, a contraction for "semidried." Removing the scud from unhaired hides and skins; remnants of epithelial tissues, hair pigment, lime soap, etc., left in the grain layer.
SCUDDING	
SEMICHROME LEATHER	Leather which has been tanned first with vegetable tannin and then retanned with chromium salts.
SETTING OUT OR STRIKING OUT	To smoothen out creases and squeeze out liquor by means of a slicker.
SHAVING	Reducing the thickness of hides after they have been tanned. Reducing the thickness before tanning is called splitting (see SPLIT, SPLIT HIDE).
SHEEP SKIN RUG	A rug made from a woolled sheepskin which has been tanned and dressed.
SHOULDER	That portion of a hide or skin covering the shoulders and neck of the animal, and the leather made therefrom (see Figure 18).
SIDE	Half of a whole hide with offal (head, shoulder and belly) attached. It is obtained by dividing the hide along the line of the backbone.
SIDE LEATHER	Shoe upper leather made from cattle hide sides.

SLICKER	A hand tool used to squeeze out moisture and to smooth the leather.
SOAKING	Immersing hides and skins in water before liming.
SOLE LEATHER BEND	Leather made from the bend region of cattle hides, tanned and finished to be suitable for the outer soles of footwear (see BEND).
SPLIT	The underlayer of a hide or skin, or part of a hide or skin separated by splitting, or leather made therefrom. If the name of the animal from which it originates, or the word "hide" or "skin," or the part of the animal from which it comes is included in the description, then the word "split" must be used as a noun — for example, pig split, hide split, butt split — and not as an adjective — for example, split pigskin (see SPLIT HIDE).
SPLIT HIDE	The outer or grain layer of a hide from which the under, or flesh side has been split to give it a reasonably uniform thickness, or leather made therefrom.
STAKING	To soften light leather by rubbing it over a vertical slicker.
STRIKER	The name often given to a tannin mordant used on leather to develop a particular color. Besides vegetable tannin mordants there are also some metallic salts which are used to "strike" or to develop a particular color. Thus, if tanned leathers are first treated with a vegetable tannin or with fustic, they can be subsequently treated with a metallic salt "striker" — for example, potash alum to strike a rich yellow shade. If other metallic salts are used as "strikers," different colors are produced.
STUFFING	The process of applying hot fats to heavy leather.
SYNTAN (SYNTHETIC TANNING AGENT)	May be defined as any synthetic high molecular organic compound or a mixture of compounds, which is capable of converting animal hide or skin into leather.
TAN	The process or method used to convert raw hides and skins into leather (see LEATHER). There are many different ways of tanning

and a large variety of materials which possess the property of being able to "tan." The process is called "tanning" and the person responsible for it, or in charge of it, is known as a "tanner."

TANNAGE, DEGREE OF

The proportion of combined tannin in a leather expressed as a percentage of the hide substance in that leather.

TANNIN

Normally, the substance or substances in a vegetable tanning material by means of which raw hides or skins can be converted into leather.

TANNING

The process of treating skins or hides with tanning agents, such as vegetable tannins, chromium salts, formaldehyde and fish oils, to produce leather.

TAN LIQUOR

A liquid containing tannins prepared either by leaching or by dissolving concentrated tannin extracts or any vegetable tanning material, such as barks, leaves and fruits.

TENSILE STRENGTH

The force required to pull apart a piece of the leather which has a specific square cross section.

TRYPSIN

See ENZYMES.

UNHAIRING

The removal of the hair or wool from hides or skins which have been treated to loosen the hair or wool. The hair or wool can be loosened by a so-called "liming" process, in which the hides or skins are immersed in an alkaline liquor prepared from slaked lime and water, or from slaked lime, sodium sulphide or hydrosulphide and water. These alkaline liquors hydrolyse and destroy the epidermis, thus loosening the hair or wool. Wool on sheepskins is sometimes loosened by sweating — that is, the epidermis is destroyed by means of a controlled putrefaction process in which the raw skins are hung in damp semi-underground chambers at a temperature of 10°C. to 15°C. After 48 hours in these chambers, the wool is loose and can be pulled off. This is usually called "pulling." Another process makes use of an enzyme to attack the epidermis. The soaked skins are first swollen by soaking them for 48 hours in a weak solution of caustic soda. This treatment is followed by the enzyme process — that is, using 1.5 to

2 percent of the enzyme on the dry weight of the skins in the hair. The enzyme treatment should be at 24°C. to 29.5°C. The epidermis will be loosened and the hair or wool can be removed in 24 hours. The hair or wool is quite undamaged. The process has proved to be popular with glazed goat tanners and with producers of gloving sheep.

UNHAIRING KNIFE

A curved knife with a blunt edge on the inner side. The knife is used to push or scrape off the hair which has been loosened on hides and skins after the liming (and unhairing) process. The knife is also used to scrape the grain of unhaird hides and skins and to work out the scud. The knife is tilted away from the operator and worked on the blunt edge.

VATS

Wooden, brick or stone tanks used for liming, tanning, etc.

VAT, CIRCULATORS

Vats full of strong tan liquor which is circulated by pump.

VAT, HANDLERS

Vats in which butts are laid horizontally, immersed in tan liquor.

VAT LAYERS OR LAY-AWAYS

Vats, similar to handlers.

VAT SUSPENDERS

Vats full of tan liquor, in which heavy hides are suspended from wooden slats.

VEGETABLE TANNED

Leather tanned exclusively with any vegetable-tanning material.

VELLUM

Translucent or opaque material with a smooth surface and suitable for writing, bookbinding and other purposes. It is made from unsplit calf, sheep and other skins, by drying out the limed skin without applying any tannage. The material is thoroughly cleansed and degreased, and the grain surface is smoothed during the process. The best vellum is made from calf (see PARCHMENT).

WHITING

Calcium carbonate or chalk.

NOTE: See also the glossary in FAO Agricultural Development Paper No. 49: *Flaying and Curing of Hides and Skins as a Rural Industry*,

SELECTED REFERENCES

Articles

- A. D. Contrôle des opérations de tanneries. *Rev. tech. Indust. Cuir.* Vol. 45, No. 11, p. 227, 1953.
- A. D. Préparation des bains de chrome. *Ibid.* Vol. 45, No. 12, p. 241, 1953.
- A. D. Gomme laque. *Ibid.* Vol. 46, No. 4, p. 80, 1954.
- ADZET, J. M. and GRATACOS, E. Nuevos métodos de curtición. *Bol. Asoc. Quim. Esp. Ind. Cuero.* Vol. 10, No. 73, 27 February 1959.
- ADZET, J. M. Aspergillus, penicillium et paecilomyces rencontrés en tannerie. *Bull. Ass. franç. Chim. Cuir.* Vol. 21, No. 4, p. 79, 1959.
- AIROLDI, R. Contributo alla conoscenza della concia all'olio. *La Chimica e l'Industria.* Vol. 40, p. 634, 1958.
- ANDERSON, H. The tanning of certain eucalyptus species and pinus radiation. *J. Soc. Leath. Tr. Chem.* Vol. 36, p. 211, 1952.
- ANONYMOUS. The Japanese "Himeji" white leather. *Leath. Tr. Rev.* p. 100, 16 April 1958.
- . Etude de quelques bactéries rencontrées en tannerie. *Bull. Ass. franç. Chim. Cuir.* Vol. 21, No. 3, p. 68, 1959.
- ANNUNZIATA, A. Der Sumak in Sizilien. *Das Leder.* Vol. 10, No. 9, p. 254, October 1958.
- BARAT, S. K. Tan fractions in Indian vegetable tanstuffs. *Leath. Tr. Rev.* p. 352, 20 November 1957.
- BEATON, W. G. Tanning and dyeing of goat skins (Northern Nigeria). *Bull. Imp. Inst., Lond.*, p. 56, 1933.
- BEEBY, K. J. The wonderful story of leather. Issued by the Leather Institute (United Kingdom) for free circulation by schools.
- BELAVSKY, E. and HREBICEK, T. Tests in one bath chrome tanning without pickle. *Leath. Tr. Rev.* pp. 369-370, 21 November 1956.
- BELAVSKY, E. et al. Basis of modern tropical chrome leather manufacture. *Leath. Tr. Rev.* p. 187, 1 May 1957; p. 236, 8 May 1957.
- BELAVSKY, E. and TERMIGNONI. Brazilian tannins. *J. Amer. Leather Chemists Ass.* Vol. 47, p. 68, 1959.

- BISCH, VICENTE YSAMAT. Defensa del cuero frente a los sucedáneos. *Bol. Asoc. Quím. Esp. Ind. Cuero*. Vol. 5, p. 97, 1954.
- BLANCHER, M. G. But et importance de l'indice d'hydroxyle. *Bull. Ass. franç. Chim. Cuir*. Vol. 19, No. 2, p. 47, 1957.
- . Depilado enzimático. *Bol. Asoc. Quím. Esp. Ind. Cuero*. Vol. 9, p. 143, 1958.
- BOIDIN, J. Les eaux résiduaires de tannerie. Leur nocivité et les possibilités de leur purification. Conférence faite au Centre de perfectionnement technique, Paris, 12 November 1952. Published by *Rev. tech. Indust. Cuir*.
- BOIDIN, J. and PRÉVOT, J. Les aspergillus rencontrés en tannerie. Leurs actions. *Bull. Assoc. franç. Chim. Cuir*. Vol. 18, No. 2, p. 47, 1957.
- BOIDIN, J. Attaque fongique des jus tannants et des cuirs de tannage végétal. *Ibid.* Vol. 20, No. 6, p. 118, 1958.
- BOIX, MIGUEL and BARBERO, ENRIQUE. El control automático en la teneria. *Bol. Asoc. Quím. Esp. Ind. Cuero*. Vol. 9, June-July 1958.
- BOSE, S. M., MADHAVA KRISHNA and DAS, B. M. An improved process for the enzymic unhairing of skins and hides by Madar (*Calotropis gigantea*). Latex for the manufacture of leather. *Bull. Central Leather Research Inst., Madras*. Vol. V, No. 1, 1958.
- . Enzymic unhairing. *Ibid.* Vol. II, No. 5, 1955.
- and MADHAVA KRISHNA. Studies on proteases and amylases as unhairing agents for skins and hides with particular reference to reactions of skin mucoids with amylases. *Ibid.* Vol. IV, No. 5, 1957.
- BRAVO, G. A. Le bois de châtaignier et son extrait tannant. *Rev. Tech. Indust. Cuir*. Vol. 44, No. 9, p. 165, No. 10, p. 185, 1952.
- . Cuoio e pelli nell'antica Roma. *Cuoio, pelli, materie concianti*, Naples. Vol. 37, p. 391, 1957.
- BULLETIN of the CENTRAL LEATHER RESEARCH INSTITUTE, Madras, India. Series of Articles called: Research bears fruit (Practical demonstrations).
- BURTON, D. and BARAT, S. K. The properties of babul bark. *J. Soc. Leath. Tr. Chem.* Vol. 38, p. 223, 1953.
- . Vegetable tanning VIII. The properties of babul bark, *Acacia arabica*. *Ibid.* Vol. 38, p. 223, 1954.
- BURTON, D. and BICKLEY, J. C. Vegetable tanning. A study of several methods for determining the natural acidity in vegetable-tanning liquors. Part I. *Ibid.* Vol. 38, p. 249, 1954.
- CABANNES, J. ARNAUD. Le pH pondéré et ses possibilités. *Chim. anal.* Vol. 35, p. 28, 1953.
- CARRERAS, JULIO and YSAMAT, LUIS. Productividad, organización del trabajo en las fábricas de curtidos. *Bol. Asoc. Quím. Esp. Ind. Cuero*. Vol. 10, No. 73, 27 February 1959.
- CARRIE, M. S., MOORE, J. B. and CHRISHOLM, J. S. The depilation of sheep skins with acetic acid. *New Zealand Journal of Science and Technology*. Vol. 38, No. 1, p. 19, 1956.
- CHAMBARD, P. and JULLIEN, I. Travaux exécutés à l'atelier de l'Institut de recherches des industries du cuir sur l'écorce d'eucalyptus sideroxydon. *Bull. Ass. franç. Chim. Cuir*. Juin 1950.

- CHAMBARD, P. Essais de salage de peaux de veaux. *Ibid.* Vol. 14, No. 9-10, p. 152, 1952.
- CHAMBARD, P. and LASSERRE, R. Le retannage végétal du cuir au chrome. *Bull. de l'Ass. Fr. des Chim. des Ind. du Cuir.* Vol. 17, No. 12, p. 219, 1955.
- CHAMBARD, P. and GASTELLU, CH. Etude sur le salage et la conservation des peaux de veaux en poil. *Rev. tech. Indust. Cuir.* Vol. 46, No. 10, p. 210, 1954.
- CHAMBARD, P., GASTELLU, CH. and JULLIEN, I. Cuir en huile de tannage chrome végétal. *Bull. Assoc. franç. Chim. Cuir.* Vol. 19, No. 1, p. 11, 1957.
- CHAMBARD, P. and JULLIEN, I. Cuirs à semelle de tannage chrome végétal. *Ibid.* Vol. 19, No. 1, p. 17, 1957.
- CHAMBARD, P. and JULLIEN, I. Vachettes en huile de tannage semi-chrome. *Ibid.* Vol. 17, No. 6-7-8, p. 121, 1955.
- CHAMBERS, M. F. Le tannage de peaux de mouton: Etude systématique de l'influence de divers facteurs dans les processus de tannage. *Rev. tech. Indust. Cuir.* Vol. 50, No. 5, p. 104, 1957.
- CZEPELAK, V. Die Trane in der Lederindustrie. *Das Leder.* Vol. 2, p. 43, 1957.
- DANBY, J. P. Swelling and plumping of hides and skins. *Leath. Tr. Rev.* p. 511, 17 December 1958; p. 161, 29 April 1959.
- DAS, B. M. and MITRA, S. K. Photomicrographic study of leather. *J. Sci. Indust. Res., Delhi.* Vol. 13B, p. 517, 1954.
- DAVOOD, O. S. and DAS, B. M. Tanning investigations for the reduction of consumption of babul bark in the North Indian bag tanning by using mixtures of sodium sulphite and bisulphite in the tannage. *Bull. Central Leather Research Inst., Madras,* Vol. II, No. 9, 1956.
- DE, J. K., CHOUDHURY, P. C. ROY and GHOSH, S. K. Method for preparation of artificial degreas. *Journal of the Indian Leather Technologists' Association.* Vol. 6, No. 4, p. 172, 1958.
- DOUGLAS, G. W. Raw materials from the Commonwealth. *Leath. Tr. Rev.* p. 445, 1957; p. 355, 1957.
- . Survey of the production of hides, skins and rough-tanned leathers in India, Pakistan, Ceylon and Africa. *British Leather Manufacturers Research Association.* September 1956.
- . White leather tannages. *Leath. Tr. Rev.* p. 217, 7 August 1957; p. 259, 14 August 1957.
- ERDI, PAUL. Quelques problèmes pratiques du tannage combiné chrome-végétal. *Rev. tech. Indust. Cuir.* Vol. 51, No. 2, p. 31, 1959.
- FEHER, STEPHAN and KERESE, STEPHAN. L'effet de déchromage des tanins végétaux de retannage dans les tannages de combinaison. *Ibid.* Vol. 52, No. 5, p. 95, 1959.
- FREUDENBERG, H. Die Bedeutung der Luftfeuchtigkeit bei der Trocknung von Chromoberledern. *Das Leder.* p. 245, October 1956.
- FURLONG, J. R. Tanning materials of the British Empire: Resources and development. *J. Int. Soc. Leath. Chem.* p. 229, 1932.

- GASTELLU, C. Les Applications du pH et du rH en tannerie. *Bull. Ass. franç. Chim. Cuir.* Vol. 14, No. 3, p. 45, 1952.
- GASTELLU, C. and JULLIEN, I. Fabrication du collet à première chrome-végétal. *Ibid.* Vol. 19, No. 12, p. 256, 1957.
- . Etude de la fabrication des collets pour semelles premières chrome-végétal. *Ibid.* Vol. 21, No. 1, p. 11, 1959.
- GASTELLU, C. et al. Etude concernant l'amélioration de la qualité de la peau brute. *Ibid.* Vol. 21, No. 1, p. 16, 1959.
- GHOSH, D., BARAT, S. K. and DAS, B. M. Weight giving property of some vegetable tannins. *Bull. Central Leather Research Inst., Madras.* Part I, Vol. I, No. 8, 1955.
- GOURLAY, PIERRE. Rappel de quelques données sur les peaux de reptiles et leur fabrication. *Rev. tech. Indust. Cuir.* Vol. 45, No. 4, p. 66, 1953.
- . Les influences électriques dans la fabrication du cuir. *Ibid.* Vol. 47, No. 7, p. 147, 1955.
- GRALL, F. Les résines synthétiques et leur emploi en tannerie. *Ibid.* Paris, 3 décembre 1952.
- GRANELL, JOSÉ MIGUEL. Curticiones combinadas. *Bol. Asoc. Quím. Esp. Ind. Cuero.* Vol. 3, p. 4, 1952.
- GRASSMANN, W. Über den Gerbstoff der Fichtenrinde. *Das Leder.* Vol. 9, No. 8, p. 193, August 1958.
- GRATACOS, E. and ADZET, J. M. Ensayos y normas de calidad del cuero para suela. *Bol. Asoc. Quím. Esp. Ind. Cuero.* Vol. 10, No. 75, p. 79, 1959.
- GREGORY, JOHN C. and RODDY, WILLIAM T. The thermal stability of leather. *J. Amer. Leather Chemists' Ass.* Vol. 47, p. 787, 1952.
- GREEN, G. H. Leather Science. Some recent developments. *Research,* London. Vol. XI, No. 9, pp. 330-334, 1958.
- GREEN, H. F. How goat skin diseases affect finished leather. *Leath. Tr. Rev.* p. 275, 7 November 1956.
- . A survey of the skin disease of goats in Kenya and their effect on the finished leather. *J. Soc. Leath. Tr. Chem.* 40, p. 259, 1956.
- GREEN, H. F. A survey of the skin diseases of cattle in Kenya and their effect on the finished leather. *J. Soc. Leath. Tr. Chem.* 41, p. 418, 1957.
- . A survey of the skin diseases of hair sheep in Kenya and their effect on the finished leather. *Ibid.* 43, p. 85, 1959.
- . Lumpy skin disease. Its effect on hides and leather and a comparison in this respect with some other skin diseases. *Bulletin of Epizootic Diseases of Africa.* 7, p. 63, 1959.
- GUSTAVSON, K. H. The destructive action of foot perspiration on leather. *J. Amer. Leather Chemists' Ass.* p. 414, 1955.
- HARNLY, JOHN, W. Tannery waste disposal methods. *Leather and Shoes.* pp. 14, 38. September 1952.
- HEMMERLING, KLAUS. The coloring of chrome-tanned grained calfskin leather. *The Textile Journal of Australia.* p. 599, 20 July 1956.
- HERFELD, H. De l'influence exercée sur la perméabilité à l'eau du cuir par la modification des conditions de fabrication. *Rev. tech. Indust. Cuir.* Vol. 51, No. 3, p. 45, 1959.

- IMMENDORFER, E. Tanning of chamois and gloving leather. *Leath. Tr. Rev.* 16 July 1952.
- INNES, R. F. The deterioration of vegetable-tanned leather on storage. V. Preparation of various leathers for storage of a prolonged period. *British Leather Manufacturers' Research Association*. Vol. XI, p. 268, Reports 1932.
- INNES, R. F., MAYER, M. H. and MITTON, R. G. The durability of upholstery leather from split hides. *J. Soc. Leath. Tr. Chem.* Vol. 37, p. 158, 1953.
- INNES, R. F. and PANKHURST, K. G. A. The degreasing of woolskins. *Ibid.* Vol. 36, p. 358, 1952.
- JACQUET, M. D. Le graissage du matériel en tannerie. *Rev. tech. Indust. Cuir.* Vol. 47, No. 10, p. 221, 1955.
- JANIS, DOROTHY C. Production of industrial quebracho. *Economic Geography*. Vol. 21, No. 2, p. 145, 1945.
- JULLIEN, I. and GASTELLU, C. Fabrication de collets pour semelles premières de tannage chrome végétal. *Bull. Ass. franç. Chim. Cuir.* Vol. 20, No. 6, p. 99, 1958.
- KIBRIA, M.A.M.G. Pretanning processes for manufacturing different types of industrial leathers. *Journal of the Indian Leather Technologists' Association*. Vol. 6, No. 4, p. 169, July-August 1958.
- KNEW, E. The influence of colored light on the drying and storage of catechol-tanned leather. *J. Soc. Leath. Tr. Chem.* p. 215, October 1943.
- KNEW, E. and RAY, A. T. The decolorising of myrobalan extract (Bhimlitan). *Ibid.* p. 186, August 1944.
- KOLLER, P. The significance of pH in leather manufacture. *CIBA Review*. No. 112, p. 4093, October 1955.
- KROCHMAL, A. and PAUR, S. Canaigre — a desert source of tannin. *Economic Botany*. p. 367, October-December 1951.
- KUBELKA, VACLAV. Le problème des eaux résiduaires de fabriques dans l'économie de l'eau en considération particulière des eaux résiduaires de tannerie. *Rev. tech. Indust. Cuir.* Vol. 50, No. 7, p. 147; No. 8, p. 168, 1958.
- LANGENBECK, WOLFGANG. Contribution à la théorie de l'action enzymatique. *Ibid.* Vol. 47, No. 6, p. 119, 1955.
- LASSERRE, R. Etude des conditions du pelanage. Influence de la température. *Bull. Ass. franç. Chim. Cuir.* Vol. 18, No. 6, p. 111; No. 7, p. 147; No. 11-12, p. 243, 1956.
- LEISTNER, H. P. Luftführung und Hygroskopisches Gleichgewicht. *Das Leder*. p. 241, October 1956.
- MARTIN, H. Formation de taches colorées sur cuirs et peaux par des microorganismes. *Bull. Ass. franç. Chim. Cuir.* Vol. 18, No. 8, p. 175, 1956.
- Utilisation rationnelle de l'acidité de l'extrait de châtaignier dans le tannage du cuir lissé. *Ibid.* Vol. 17, No. 9, p. 147; No. 10, p. 169, 1955.
- MEDINA, G. Nuevos productos para el depilado de pieles. *Bol. Asoc. Quím. Esp. Ind. Cuero*. Vol. 1, p. 4, 1950.

- MITTON, R. G. The diffusion of water vapour in leather. *J. Amer. Leather Chemists' Ass.* p. 385, 1955.
- MITTON, R. G. and POMEROY, C. D. Trocknung von Leder, das viel gelöste Stoffe enthält. *Das Leder.* p. 247, October 1956.
- , Damage to pelt caused by overheating during drying. *J. Soc. Leath. Tr. Chem.* p. 104, March 1957.
- MUDALIAR, RAJABATHER. General method of manufacturing East India tanned kips. *Bull. Central Leather Research Inst., Madras.* Vol. 1, No. 6, 1955.
- NAYUDAMMA, Y. Some chemical engineering aspects of leather manufacture. *J. Sci. Indust. Res., Delhi,* Vol. 13A, p. 438, 1954.
- NAYUDAMMA, Y. Combination tannages: Chrome-vegetable tanning. I. *Ibid.* New Delhi, Vol. 12A, p. 462, 1953.
- NAYUDAMMA, F., RANGANATHAN, T. S. and DAS, B. M. Physical and chemical characteristics of some Indian leathers. III. Indian chamois leathers. *Bull. Central Leather Research Inst., Madras,* Vol. III, No. 1, 1956.
- NAYUDAMMA, Y., JAYARAMAN, K. S. and KRISHNAN, T. S. The effect of acids and salts in vegetable tanning. I. The effect of some salts in sole-leather tannage. II. The effect of salts and myrobing on the chemical and physical properties of wattle-tanned sole leather. III. The effect of pre-treatment of the pelt or the liquor with a number of salts on wattle, wattle and myrob, tannage of sole leather. *Ibid.* Vol. III, Nos. 4 and 5, 1956.
- NIVERT, R. and FORÉ, J. Contribution à la solution des problèmes de nourriture posés par le séchage sur glace. *Rev. tech. Indust. Cuir.* Vol. 51, No. 2, p. 25, 1959.
- OTTO, G. 25 Jahre Lederzurichtung mit Kunststoffdispersionen. *Das Leder.* p. 252, October 1956.
- , Ein Beitrag zur Kenntnis der Pflanzlichen Nachgerbung von Chromleder. *Ibid.* Vol. 9, No. 12, p. 299, 1958.
- PAGANS LLAURO, REINERIO. Influencia del quebracho en la calidad de la suela. *Bol. Asoc. Quím. Esp. Ind. Cuero.* Vol. 6, p. 171, 1955.
- PEARMAN, R. W. Mangrove bark. Its value as a tanning material. *Leath. Tr. Rev.* p. 315, 28 August 1957.
- PENAUD, P. Pigments et produits de finissage. *Bull. Ass. franç. Chim. Cuir.* Vol. 18, No. 9, p. 203, 1956.
- PERLMUTTER, M. L'évolution et l'état actuel de la décoloration des peaux de fourrures. *Rev. tech. Ind. Cuir.* Vol. 51, No. 1, p. 1, 1955.
- PETRIE, W. Preparing dry hides for tanning. *Leath. Tr. Rev.* p. 163, 21 January 1953.
- , 43 process defects which tanners have to avoid. *Ibid.* p. 601, 27 June 1956.
- , Basic tanning principles for making sound leather. *Ibid.* p. 511, 12 December 1956.
- PEUREAUX, PIERRE. Les extraits spéciaux de châtaignier. *Rev. tech. Indust. Cuir.* Vol. 47, No. 9, p. 188, 1955.
- , Le déchaulage. *Bull. Ass. franç. Chim. Cuir.* Vol. 19, No. 4, p. 106, 1957.

- P. G. Les *Caesalpinia* comme matières tannantes. *Rev. tech. Indust. Cuir.* Vol. 45, No. 3, p. 52, 1953.
- PORTAVELLA, MANUEL. Comparación entre dos modalidades de piquel. *Bol. Asoc. Quím. Esp. Ind. Cuero.* Vol. 9, p. 265, 1958.
- PRESSLEY, T. A. Fellmongering. *The Australian Leather Trades Review.* Vol. 48, p. 5, 1952.
- RAHIM, MUSTAIFIZUR SYED. Utilization of the by-products of the tanning industry. *Ibid.* Vol. 50, p. 3, 1954.
- RANGANATHAN, T. S. and NAYUDAMMA, Y. Combination tannages. Part IV. Combination chrome-vegetable tanning in single bath. *Bulletin of the Central Leather Research Institute.* Vol. III, No. 11, June 1957; No. 12, July 1957; Vol. IV, No. 1, August 1957.
- RAO, J. B. and NAYUDAMMA, Y. Survey of the indigenous tanning materials of the Madras State. Part IV. Dhawa leaves (*Anogeissus latifolia*). *Ibid.* Vol. IV, No. 3, October 1957.
- RAO, A. L. SUNDARA and SELVARANGAN, R. Studies in the East Indian tannage of skins. Part I. *J. Sci. Industr. Res.* Delhi, Vol. 11B, p. 176, 1952.
- RAO, J. BUDAGA, NAYUDAMMA, Y. and DAS, B. M. A survey of the indigenous tanning materials of the Madras State. Part I. White-valein bark (*Acacia leucophloea*). *J. Sci. Industr. Res.*, Delhi. Vol. 13B, p. 867, 1954.
- RAO, P. HANUMANTA. Inactivation of basic groups of collagen by treatment with syntans and its effect on vegetable tannin fixation. *Ibid.* Vol. 14C, p. 75, 1955.
- READER, D. E. On the use of shark skins for leather. *Leath. Tr. Rev.* p. 181, 29 October 1952.
- RIVIÈRE, M. Communication relative aux meilleures conditions de conservation des cuirs et peaux bruts. *Bull. Ass. franç. Chim. Cuir.* Vol. 21, No. 2, p. 44, 1959.
- ROGERS, J. S. and PULTZ, L. M. Canaigre. A possible domestic source of vegetable tannin. *Shoe and Leather Reporter.* 27 December 1952.
- ROSE, C. D. and TURNER, S. N. Mould growth on leather as affected by humidity changes. *J. Soc. Leath. Tr. Chem.* Vol. 35, pp. 37, 82 and 290, 1951.
- ROUANET, CHARLES. L'amélioration des solidités des teintures sur peausseries. *Bull. Ass. franç. Chim. Cuir.* Vol. 18, No. 9, p. 195, 1956.
- SAGONCHEN, J. A. Qualitätsbestimmung von Vache- und Sohlleder. *Das Leder.* Vol. 4, p. 37, 1953.
- . La détermination quantitative des sédiments dans les extraits tannants. *Rev. tech. Indust. Cuir.* Vol. 50, No. 6, p. 121, 1958.
- SARKAR, S. K., MITRA, S. K. and DAS, B. M. A study on the effect of shell lime on the fibre structure of the pelt in liming cow hides. *Bull. Central Leather Research Inst., Madras,* Vol. III, No. 2, 1956.
- SCHOLZ, HERBERT. Procédés pour l'épuration des eaux résiduaires de tanneries. *Rev. tech. Indust. Cuir.* Vol. 50, No. 4, p. 74, 1958.
- . L'état de la technique des eaux résiduaires dans les fabriques de cuir d'Europe. *Ibid.* Vol. 51, No. 1, p. 13, 1959.

- SELVARANGAN, R. Arecanut as a tanning material. *Bulletin of the Central Leather Research Institute*. Vol. I, No. 10, 1955.
- SELVARANGAN, R., GHANI, M. A. and NAYUDAMMA, Y. Manufacture of white glove and lining leathers using basic aluminium sulphate. *Ibid.* Vol. V, No. 3, October 1958.
- SESHACHALAM CHOUDRAY, K. and NAYUDAMMA, Y. Avaram bark, analysis-extraction and use. *J. Soc. Leath. Tr. Chem.* Vol. 31, p. 284, 1947.
- Studies on Konnam bark. *Ibid.* Vol. 32, p. 211, 1948.
- SHUTTLEWORTH, S. G. Recent South African developments in rapid wattle sole leather tannage. *Journal of the Indian Leather Technologists' Association*. Vol. 6, No. 4, July-August 1958.
- Sohlledergerbung in warmen Mimosa extraktbrühen von konstant gehaltener Konzentration. *Das Leder*. Vol. 10, No. 5, p. 97, 1959.
- The mechanism of vegetable tannage. *J. Amer. Leather Chemists' Ass.*, Vol. 47, p. 603, 1952.
- SNIJDERS, J. H. Inleiding tot de Dermoplastiek [Introduction to the dermoplastic]. *Indonesian Journal for Natural Science*. Vol. 108, Nos. 4 and 5, p. 80, 1952.
- SORMANI, R. Die Edelkastanie in Europa. *Das Leder*. Vol. 7, No. 9, p. 229, 1956.
- SPIERS, C. H. The rise and development of leather manufacture. *Leath. Tr. Rev.* p. 307, 19 February 1958.
- STATHER, F. Schweinshaut und Schweinsleder. *Das Leder*. Vol. 9, No. 2, p. 35, 1958.
- STRATTA, RAINERO. La représentation graphique des principes du travail en tannerie. *Bull. Ass. franç. Chim. Cuir*. Vol. 19, No. 5-6, p. 115, 1957.
- THUAU, URBAIN, J. Méthode scientifique et pratique de conservation parfaite et de salage des peaux. *Rev. tech. Indust. Cuir*. Vol. 45, No. 1, p. 1, 1953.
- Cuir à semelle perméables à l'air imperméables à l'eau. *Ibid.* Vol. 46, No. 10, p. 205, 1954.
- VARMA, M. K. U., MATHEW, E. C. and DAS, B. M. Effect of acid and salt adjustment in E. I. tannage with *Peltophorum ferrugineum* bark. *Bull. Central Leather Research Inst., Madras*, Vol. IV, No. 2, 1957.
- Effect of acid and salt adjustment in E. I. tannage with *Pithecolobium dulce*. *Ibid.* Vol. III, pp. 110-14, 1956.
- New barks for E. I. tannage. II. *Pithecolobium dulce*. *Ibid.* Vol. II, pp. 204-9, 1956.
- VARMA, M. K. U., MATHEW, E. C. and DAS, B. M. Sole leather tannage using *Pithecolobium dulce* bark. *Ibid.* Vol. II, No. 12, July 1958.
- VENKATACHALAM, P. S. Manufacture of suedes and lining leathers from E. I. goats. *Ibid.* Vol. III, No. 10, May 1957.
- VIVENTE BEL, J. L. Estudio bibliográfico sobre el proceso de engrasado en bombo. *Bol. Asoc. Quím. Esp. Ind. Cuero*. Vol. 6, p. 26, p. 59, 1955.

- VLIMMEREN, P. J. Die zeitliche Änderung der Wasserabgabeschwindigkeit im Laufe der Ledertrocknung. *Das Leder*. p. 248, October 1956.
- VOURLLOUD, H. and DESJOURS, G. Essais de salage de veaux en présence d'antiseptiques. *Bull. Ass. franç. Chim. Cuir*. Vol. 14, No. 9-10, p. 133, 1952.
- WOODROFFE, D. Alum tannage. *Leath. Tr. Rev.* Vol. 104, p. 64, 1952.

Books

- ANNUNZIATA, A. *Fellmongering*. Wool Science Review. December 1951 and 1952. Published by the International Wool Secretariat, London.
- ARNOLD, T. R. *Hides and Skins (Raw Material Markets)*. Shaw, Chicago and New York. 1925.
- ATEN, A., INNES, R. F. and KNEW, E. *Flaying and Curing of Hides and Skins as a Rural Industry*. See Food and Agriculture Organization of the United Nations, 1955.
- BÉRARD, J. *Cuir et peaux. « Que sais-je? » Le point des connaissances actuelles*. Presses Universitaires de France, 1951.
- BRITISH LEATHER MANUFACTURERS' RESEARCH ASSOCIATION. *Hides, Skins and Leather under the Microscope*. Milton Park, Egham, Surrey, 1955.
- . *Progress in Leather Science 1920-1945*. 1946; 1948.
- CARNELL, H. A. *Leather*. George Gill and Sons, London.
- CASSEL, J. M., DAHL, S. and KANAGY, J. R. *Quality Control of Leather in the U.S.A.* Leather Section, U.S. Department of Commerce, Washington (pamphlet undated).
- CLARKE, IRA D. and OTHERS. *Tannin Content and Other Characteristics of Native Sumac in Relation to its Value as a Commercial Source of Tannin*. Technical Bulletin No. 986, United States Department of Agriculture, Washington, December 1949.
- COMMISSION INTERNATIONALE des INDUSTRIES AGRICOLES. *Bibliographie sur le mimosa*. Paper No. B/2688, 27 September 1955.
- . *L'épilage aux enzymes*. 28 January 1957.
- DAS, B. M. *Handbook of Tanning*. Bengal Government Press, Alipore, West Bengal.
- DAS GUPTA, SATISH CHANDRA and VALUNJKAR, G. R. *Dead Animals to Tanned Leather*. Wardha, India, April 1942.
- DE BEUKELAER, L. FRANK and HSI WANG. *Important Factors in Effective Dehairing of Hogs and Improving Quality of Skins*. Bulletin No. 23, American Meat Institute Foundation, Chicago, 1955.
- FOOD AND AGRICULTURE ORGANIZATION OF THE UNITED NATIONS. *Equipment for the Tanning of Hides and Skins*, by Luther R. Ray and E. Beekman. FAO Agricultural Development Paper No. 13, 1951.
- . *Flaying and Curing of Hides and Skins as a Rural Industry*, by A. Aten, R. F. Innes and E. Knew. FAO Agricultural Development Paper No. 49. 1955.

- FURLONG, J. R. *The Preparation of Empire Hides and Skins*. Imperial Institute, London, 1937.
- GNAMM, H. *Fachbuch für die Lederindustrie*. Wissenschaftliche Verlagsgesellschaft, Stuttgart, 1940.
- . *Die Fettstoffe des Gerbers*. Wissenschaftliche Verlagsgesellschaft, Stuttgart, 1951.
- GOBILLARD, J. *Tannage et corroyage des cuirs et peaux*. Editions Peyrolles, Paris, 1955.
- GRASZMANN, W. *Handbuch der Gerbereichemie und Lederfabrikation*. Springer-Verlag, Vienna, 1938, 1939, 1944.
- GUSTAVSON, K. H. *The Chemistry of Tanning Processes*. Academic Press, New York, 1956.
- GUSTAVSON, K. H. *Chemistry of Collagen*. Academic Press, New York, 1956.
- FREUDENBERG, H. *Internationales Wörterbuch der Lederwirtschaft*. 2nd ed. Spring-Verlag, Berlin, 1951.
- HÉRITIER, PHILIPPE. *Cuirs d'art et poésie - Airs anciens*. Editions du Pigeonnier. Rodez (Aveyron), 1958.
- HOWES, F. N. *Vegetable Tanning Materials*. Butterworths Scientific Publications, London, 1953.
- KNEW, E. *A Note on the Native Tanner of the Sudan and Some Proposed Production Developments*. Sudan Government, Pam. 10/47, October 1947.
- KNEW, E. *Leather Manufacture in Britain*. Sudan Veterinary Service [undated].
- LAURENCE-LORD, D. *Sole Leather*. Faval Press, London, 1938.
- LEATHER TANNING INDUSTRY in the PHILIPPINES. National Economic Council, Industrial Development Centre, Manila, 1958.
- LEATHER INDUSTRIES RESEARCH INSTITUTE. *Wattle Tannin and Mimosa Extract*. Grahamstown, Union of South Africa, 1955.
- LOEWE, H. *Einführung in die Chemische Technologie der Lederherstellung*. Eduard Roeter Verlag, Darmstadt, 1959.
- MANN, I. *A Handbook on Hides and Skins*. The Government Printer, Nairobi, Kenya. Revised 1951.
- . *The Preparation of Crocodile Skins for Export*. The Government Printer, Nairobi, Kenya, 1954. (See also the *Leather Trades' Review*, p. 605, 16 December 1953.)
- . *A Handbook on Nigerian Hides and Skins*. The Government Printer, Kaduna, Nigeria, 1957.
- MCLAUGHLIN, G. D. and THEIS, E. R. *The Chemistry of Leather Manufacture*. Reinhold Publishing Corp., New York.
- MERRY, E. W. *The Chrome Tanning Process*. Harvey, London, 1936.
- MEUNIER, LOUIS and VANEY, CLÉMENT. *La tannerie* (2 vol.). Gauthier-Villars, Paris, 1951.
- MINNOCH, J. K. *Hides and Skins*. Prepared by Education Committee National Hide Association. Jacobsen Publishing Co., Chicago, 1956.
- MUDD, J. S. *Leather Finishes*. A. Harvey Publisher, London, 1939.

- NOPITSCH, M. *Micro-Organic Attack on Leather*. CIBA Review, 100, p. 3600. Basle, October 1953.
- O'FLAHERTY, F., RODDY, W. T. and LOLLAR, R. M. *The Chemistry and Technology of Leather*. Vol. I. *Preparation for Tannage*. Vol. II. *Types of Tannages*. Vol. III. *Process Control of Quality Leather*. Reinhold Publishing Corporation, New York.
- ORGANIZATION for EUROPEAN ECONOMIC COOPERATION. *The Hides and Skins Industry in Europe*. Paris, 1956.
- ORTHMANN, A. C. *Tanning Processes*. Rumpf Publishing Co., Chicago, 1945.
- OTTO, GERHARD. *Die Lederherstellung*. Carl Hanser Verlag, Munich, 1954.
- PAILLARD, PIERRE. *Le tanneur et le mégissier*. J. B. Baillièrè, Paris, 1945.
- PROCTER, H. R. *The Making of Leather*. University Press, Cambridge, 1914.
- *Principles of Leather Manufacture*. F. N. Spon, London, and Van Nostrand, New York, 1922.
- QUEF, PIERRE. *La maroquinerie*. Lamarre, Paris, 1951.
- *Technologie du cuir*. Lamarre, Paris, 1951.
- QUEF, PIERRE and AUDRAIN, EMILE. *La sellerie-marroquinerie, articles de voyages et de chasse*. Montély, Paris, 1949-50.
- RAY, LUTHER R., and BEEKMAN, E. *Equipment for the Tanning of Hides and Skins*. See Food and Agriculture Organization of the United Nations, 1951.
- RAYMOND, W. D. *The Use of Acacia Pods and Bark as Tanning Materials*. Colonial Products Advisory Bureau (Plant and Animal). H.M. Stationery Office, London, 1952.
- RECUEIL DES MÉTHODES OFFICIELLES D'ANALYSE DE L'ASSOCIATION FRANÇAISE des CHIMISTES des INDUSTRIES du CUIR. Ecole française de tannerie. Lyon, 1959.
- SAGOSCHEN, J. A. *Einführung in die Technologie des Leders*. Format, Vienna, 1951.
- SAGOSCHEN, J. A. and KIRNBAUER, F. *Der Gerber in der Kunst*. Eigenverlag VOLT Verein Osterreichischer Ledertechniker, 1958.
- SMITH, P. I. *Principles and Processes of Light Leather Manufacture*. Chapman and Hall, London, 1942.
- STATHER, F. *Gerbereichemie und Gerbereitechnologie*. Akademie-Verlag, Berlin, 1951.
- TANCOUS, J. J., RODDY, W. T. and O'FLAHERTY, F. *Skin, Hide and Leather Defects*. Tanners' Council Laboratory, Cincinnati, Ohio, 1959.
- TOMISEK, M. *Haut- und Lederfehler*. Staatsverlag Technische Literature, Prague, 1957.
- UNITED NATIONS, ECONOMIC COMMISSION FOR ASIA AND THE FAR EAST. *Promotion and coordination on research and experiments on the leather industry in the ECAFE region*. Working Party on Cottage and Small-Scale Industries and Handicraft Marketing. Fifth Meeting, 17-24 June 1947. 1957.
- WATERER, J. W. *Leather in Life, Art and Industry*. Faber and Faber, London, 1946.

- WILSON, J. A. *Modern Practice in Leather Manufacture*. Reinhold Publishing Corp., New York, 1941.
- . *The Chemistry of Leather Manufacture*. Reinhold Publishing Corp., New York, 1958.
- WOODROFFE, D. *Leather Manufacture*. Jos. Tebbutt Swan Press, Northampton, 1950.
- . *Leather Dressing, Dyeing and Finishing*. Quality Books, Teignmouth, Devon, England, 1953. (For further information on this subject in French, see the *Revue technique des industries du cuir*).
- WOODROFFE, D. *A Handbook on Chrome Tanning*. Quality Books, Teignmouth, Devon, England, 1956.

FAO Expanded Technical Assistance Program Reports

- INNES, R. FARADAY. *Report to the Government of Libya on the Improvement in Flaying, Curing and Tanning of Hides and Skins*. No. 216, December 1953.
- ANDERSON, C. M. *Report to the Government of Ethiopia on Improvement, Preparation and Processing of Hides and Skins*. No. 303, December 1954.
- HARDING, C. F. *Report to the Government of Libya on Improvement of Flaying and Curing of Hides and Skins*. No. 441, January 1956.
- VAN HOORN, G. C. *Report to the Government of Iraq on Improvement of Flaying, Curing and Tanning of Hides and Skins*. No. 474, March 1956.
- DUNNILL, E. *Report to the Government of Egypt on Improvement of Hides and Skins*. No. 472, March 1956.
- HARDING, C. F. *Report to the Government of Iraq on the Improvement in Flaying, Curing and Tanning of Hides and Skins*. No. 651, 1957.
- STEINER, FRITZ. *Rapport au gouvernement d'Haïti sur l'amélioration des méthodes de dépouillement et de conservation des cuirs et peaux et les problèmes connexes*. No. 699. 1957.
- HOEK, F. H. *Report to the Government of India (State Government of Uttar Pradesh) on Improvements in Flaying, Curing and Tanning of Hides and Skins, and Related Matters*. No. 664, 1957.
- VAN HOORN, G. C. *Report to the Government of Gambia on the Improvement of Hides, Skins, Leather and Leather Articles*. No. 826, 1958.
- VAN HOORN, G. C. *Report to the Government of Libya on the Improvement of Hides, Skins, Leather and Leather Articles*. No. 975, 1958.

On Trade Products

A number of technical publications are invariably made available by the manufacturers of particular tannery chemicals, vegetable-tanning extracts, dyes and so on, which can be very helpful to the practical man.

FAO SALES AGENTS AND BOOKSELLERS

Algeria	Société nationale d'édition et de diffusion (SNED), Algiers.
Argentina	Librería de las Naciones, Cooperativa Ltda., Alsina 500, Buenos Aires.
Australia	Hunter Publications, 58A Gipps Street, Collingwood, Vic. 3066; The Assistant Director, Sales and Distribution, Australian Government Publishing Service, P.O. Box 84, Canberra, A.C.T. 2600, and Australian Government Publications and Inquiry Centres in Canberra City, Melbourne, Sydney, Perth, Adelaide and Hobart.
Austria	Wilhelm Frick Buchhandlung, Graben 27, Vienna 1.
Bangladesh	Shilpa Niketan, 29 D.I.T. Super Market, Mymensingh Road, Dacca-2.
Belgium	Agence et Messageries de la Presse, 1 rue de la Petite-Ile, Brussels 7.
Bolivia	Librería y Editorial "Juventud," Plaza Murillo 519, La Paz; Librería Alfonso Tejerina, Comercio 1073, La Paz.
Brazil	Livraria Mestre Jou, Rua Guaipá 518, São Paulo 10; Rua Senador Dantas 19-S205/206, Rio de Janeiro.
Bulgaria	Hèmus, 11 place Slaveïkov, Sofia.
Canada	Information Canada, Ottawa.
Chile	Biblioteca, FAO Oficina Regional para América Latina, Av. Providencia 871, Casilla 10095, Santiago; Editorial y Distribuidora Orbe Ltda., Galería Imperio 256, Santiago; Cámara Latinoamericana del Libro, Casilla Postal 14502, Correo 21, Santiago.
China	China National Publications Import Corporation, P.O. Box 88, Peking.
Costa Rica	Imprenta y Librería Trejos S.A., Apartado 1313, San José.
Cuba	Instituto del Libro, Calle 19 y 10 N° 1002, Vedado.
Cyprus	MAM, P.O. Box 1722, Nicosia.
Denmark	Ejnar Munksgaard, Norregade 6, Copenhagen S.
Dominican Republic	Librería Dominicana, Calle Mercedes 45-47-49, Santo Domingo.
Ecuador	Librería Universitaria, García Moreno 739, Quito; Su Librería, Plaza de Independencia, Quito.
Egypt	Al Ahram, El Galaa St., Cairo.
El Salvador	Librería Cultural Salvadoreña S.A., 6ª Calle Oriente 118, Edificio San Martín, San Salvador.
Finland	Akateeminen Kirjakauppa, 2 Keskuskatu, Helsinki.
France	Editions A. Pedone, 13 rue Soufflot, 75005 Paris.
Germany, F. R.	Alexander Horn Internationale Buchhandlung, Spiegelgasse 9, Postfach 2163, Wiesbaden.
Ghana	Ghana Publishing Corporation, P.O. Box 3632, Accra.
Greece	"Eleftheroudakis," 4 Nikis Street, Athens.
Guatemala	Agencia de Representaciones "Orbes," Apartado Postal 753, Guatemala.
Haiti	Max Bouchereau, Librairie "A la Caravelle," B.P. 1118, Port-au-Prince.
Hong Kong	Swindon Book Co., 13-15 Lock Road, Kowloon.
Iceland	Snaebjörn Jónsson and Co. h.f., Hafnarstraeti 9, P.O. Box 1131, Reykjavik.
India	Oxford Book and Stationery Co., Scindia House, New Delhi; 17 Park Street, Calcutta.
Indonesia	P.T. Gunung Agung, 6 Kwitang, Djakarta.
Iran	Economist Tehran, 99 Sevom Esfand Avenue, Tehran.
Iraq	Mackenzie's Bookshop, Baghdad.
Ireland	The Controller, Stationery Office, Dublin.
Israel	Emanuel Brown, P.O. Box 4101, 35 Allenby Road, and Nachlat Benyamin Street, Tel Aviv; 9 Sblomzion Hamika Street, Jerusalem.
Italy	Libreria Internazionale Rizzoli, Largo Chigi, 00187 Rome; Libreria Scientifica Dott. L. De Biasio "Aeiou," Via Meravigli 16, 20123 Milan; Libreria Commissionaria Sansoni, S.p.A., Via Lamarmora 45, 50121 Florence; Libreria Macchiaroli, Via Carducci 55/59, 80121 Naples.
Japan	Maruzen Company Ltd., P.O. Box 5050, Tokyo Central 100-31.
Kenya	The E.S.A. Bookshop, P.O. Box 30167, Nairobi; University Bookshop, University College, P.O. Box 30197, Nairobi.
Korea	The Eul-Yoo Publishing Co. Ltd., 5 2-Ka, Chong-ro, Seoul.
Kuwait	All Prints Distributors and Publishers, P.O. Box 1719, Kuwait.
Lebanon	Dar Al-Maaref Liban S.A.L., place Riad El-Solh, B.P. 2320, Beirut.
Malaysia	Caxton Stationers Ltd., 13-15 Leboh Pasar Besar, Kuala Lumpur; Parris Book Centre, 25 Lobby Arcade, K.L. Hilton, In. Treacher, Kuala Lumpur.

FAO SALES AGENTS AND BOOKSELLERS

Mauritius	Nalanda Company Limited, 30 Bourbon Street, Port Louis.
Mexico	Sucesión de Manuel Gómez Pezuela y M., Donceles 12, México, D.F.; Editorial Iztaccihuatl, S.A., Miguel Schultz 21, México 4, D.F.; Av. Morelos Ote 437, Monterrey, N.L.; Colón 175, Guadalajara, Jal.; Librería Casarrubias, S.A., Apartado Postal 1-992, Guadalajara, Jal.; Librería Agropecuaria, Av. La Paz 1522, Guadalajara, Jal.
Morocco	Librairie "Aux Belles Images," 281 avenue Mohammed V, Rabat.
Netherlands	N.V. Martinus Nijhoff, Lange Voorhout 9, The Hague.
New Zealand	Government Printing Office: Government Bookshop at Rutland Street, P.O. Box 5344, Auckland; Mulgrave Street, Private Bag, Wellington; 130 Oxford Terrace, P.O. Box 1721, Christchurch; Princes Street, P.O. Box 1104, Dunedin; Alma Street, P.O. Box 857, Hamilton.
Nicaragua	Librería Universal, 15 de Septiembre 301, Managua.
Nigeria	University Bookshop Nigeria Ltd., University College, Ibadan.
Norway	Johan Grundt Tanum Forlag, Karl Johansgt. 43, Oslo.
Pakistan	Mirza Book Agency, 65 The Mall, Lahore 3.
Panama	Agencia Internacional de Publicaciones J. Menéndez, Apartado 2052, Panama.
Peru	Librería La Universidad, Av. Nicolás de Piérola 639, Lima; Librería Studium, Amargura 939, Lima; Distribuidora Inca, Emilio Althaus 470, Lince, Lima.
Philippines	The Modern Book Company, 928 Rizal Avenue, Manila.
Poland	Ars Polona-Ruch, Krakowskie Przedmiescie 7, Warsaw.
Portugal	Livraria Bertrand, S.A.R.L., Apartado 37, Amadora; Galeria Itau, Rua de Entrecampos 66-A, Lisbon 5.
Romania	Rompresfilatelia, P.O. Box 2001, Bucharest (periodicals only); Romlibri, Str. Biserica Amzei 3-5, Bucharest (nonperiodical publications).
Saudi Arabia	Khazindar Establishment, King Faysal Street, Riyadh.
Singapore	Parrys Book Centre, 25 Lobby Arcade, K.L. Hilton, Iln. Treacher, Kuala Lumpur (Malaysia).
Somalia	"Samater's," P.O. Box 936, Mogadiscio.
Spain	Librería Mundi-Prensa, Castelló 37, Madrid; Librería Agrícola, Fernando VI 2, Madrid 4; José Bosch, Librero, Ronda Universidad 11, Barcelona; "Adlha," Av. General Mitre 100, Barcelona.
Sri Lanka	M.D. Gunasena and Co. Ltd., 217 Norris Road, Colombo 11.
Sweden	C.E. Fritze, Fredsgatan 2, 103 27 Stockholm 16; Universitetsbokhandel, Sveavägen 166, Stockholm Va.; Gumperts A.B., Göteborg.
Switzerland	Librairie Payot S.A., Lausanne and Geneva; Hans Raunhardt, Kirchgasse 17, Zurich 1.
Syrian Arab Rep.	Librairie Internationale, B.P. 2456, Damascus.
Tanzania	Dar es Salaam Bookshop, P.O. Box 9030, Dar es Salaam.
Thailand	FAO Regional Office for Asia and the Far East, Maliwan Mansion, Bangkok; Suksapan Panit, Mansion 9, Rajadamnern Avenue, Bangkok.
Togo	Librairie du Bon Pasteur, B.P. 1164, Lomé.
Turkey	Librairie Hachette, 469 Istiklal Caddesi, Beyoglu, Istanbul.
Uganda	The E.S.A. Bookshop, P.O. Box 2615, Kampala.
United Kingdom	Her Majesty's Stationery Office, 49 High Holborn, London, W.C.1; P.O. Box 569, London, S.E.1 (trade and London area mail orders); 13a Castle Street, Edinburgh EH2 3AR; 109 St. Mary Street, Cardiff CF1 1JW; 7 Linenhall Street, Belfast BT2 8AY; Brazennose Street, Manchester M60 8AS; 258 Broad Street, Birmingham 1; 50 Fairfax Street, Bristol BS1 3DE.
United States of America	UNIPUB, Inc., 650 First Avenue, P.O. Box 433, Murray Hill Station, New York, N.Y. 10016.
Uruguay	Barreiro y Ramos, 25 de Mayo esq. J.C. Gómez, Montevideo; Librería Albe, Soc. Com., Cerrito 566, Montevideo.
Venezuela	Librería Politécnica, Apartado 50738, Sabana Grande, Caracas; Librería del Este, Pericás S.A., Av. Fco. de Miranda 52, Edificio Galipán, Caracas.
Yugoslavia	Jugoslovenska Knjiga, Terazije 27/11, Belgrade; Prosveta Export-Import Agency, Terazije 16, Belgrade; Cankarjeva Založba, P.O. Box 201 - IV, Ljubljana.
Other countries	Requests from countries where sales agents have not yet been appointed may be sent to: Distribution and Sales Section, Food and Agriculture Organization of the United Nations, Via delle Terme di Caracalla, 00100 Rome, Italy.

FAO publications are priced in U.S. dollars and pounds sterling. Payment to FAO sales agents may be made in local currencies.