

Magnet Man

Cool Experiments with Magnets

This web site is devoted to magnetism and the cool experiments you can do with permanent magnets and electro-magnets. Some of the experiments are very basic - things you've done since second grade. Others are unique; perhaps you hadn't thought of doing some of these before, or had difficulty in trying to set them up. Lists of the materials needed for the demonstrations, directions on how to assemble them, instructions on how to show them, and notes on how they work are all here for you. Also shown are several cool magnetic toys you can buy. Of course, there are also links to useful sites, sources and books on magnets.

Have fun experimenting!

[Rick Hoadley](#)

(For other [cool toys and puzzles](#), check this out)



Last updated: 15Dec2003. More to come! [Here's what's new.](#)

Wherever you see **EXPT**, that means that at the underlined link there is some kind of experiment you can buy or build which will help you learn about the world of magnetism.



Magnet basics

- [Safety Considerations](#)
- [What is magnetism?](#)
 - What is a magnet?
 - History
 - Ferromagnetism
 - Diamagnetism **EXPT**
 - Paramagnetism
 - What are magnets used for?
- [Ten Facts About Magnetism](#)
- [What types of magnets are there?](#)
 - Permanent magnets
 - Temporary magnets
 - Electromagnets
 - Materials used for permanent magnets
 - Shapes
 - What does the inside of a magnet look like?
 - Magnetization configurations **EXPT**
- [What affects the strength of a magnet?](#)
 - Material
 - Temperature **EXPT**

- Demagnetizing fields **EXPT**
- Physical impact **EXPT**
- What is near the Geographic North Pole, a Magnetic North or a Magnetic South?
- Experiment **EXPT**
- Flip-flopping poles
- Magnetism in space
- Earth
- Sun
- Planets
- Meteorite Dust **EXPT**
- How do magnets work?
- Atomic Magnetism
- Magnetic Domains
- Magnetic Poles
- Is there free energy in magnets?

Experiments with magnets and our surroundings

- What is attracted to magnets?
- Metals **EXPT**
- Minerals **EXPT**
- Ferrofluids **EXPT**
- Other Objects (vcr tapes, dollar bills, floppy disks, iron in cereal) **EXPT**
- Problems with 2 and 3 unknown rods
- How strong are magnets?

- Typical values
- Measuring the strength of magnets
- Hall effect devices
- Helmholtz coils **EXPT**
- Halbach Array
- Paper clips and ball bearings **EXPT**
- Magnetometer
- Answers to the rod problems
- What do magnetic fields look like?
- What are magnetic fields
- What creates the magnetic field?
- What is the relationship between current flow and magnetic fields?
- A word about conventions regarding the direction of current and field lines
- What do we know about magnetic field lines?
- What are magnetic fields made of?
- How can I visualize a magnetic field? **EXPT**
- What can shield a magnetic field? **EXPT**
- A science fair project **EXPT**
- Magnet math
- Terms and definitions
- Conversions
- Equations and calculations
- Lenz's Law
- Faraday's Law of Induction

- Maxwell's Equations
- Designing magnetic circuits
- Magnets and biology
- Do magnetic fields affect biological organisms? **EXPT**
- Navigating with magnets **EXPT**
- Cool magnetic toys you can buy **EXPT**

Experiments with magnets interacting with other magnets

- Donut magnets **EXPT**
- Herky-Jerky **EXPT**
- Levitating Train **EXPT**
- Ball Bearing Launcher **EXPT**
- More cool magnetic toys you can buy **EXPT**

Experiments with magnets and conductors

- Types of conductors and their properties
- Pendulum **EXPT**
- Aluminum Disk **EXPT**
- Magnetic Plumb **EXPT**
- Copper Pipes **EXPT**
- Spinning Copper Plate **EXPT**
- Superconductors **EXPT**

Experiments with electromagnets

- Electromagnets

- What is an electromagnet?
- Winding a coil **EXPT**
- Transformers **EXPT**
- Jacob's Ladder **EXPT**
- Battery Powered Electromagnet **EXPT**
- The Plank **EXPT**
- Audio Speakers **EXPT**
- Make A Speaker! **EXPT**
- AC Electromagnets **EXPT**
- DC Electromagnets **EXPT**
- An Easy Electromagnet Experiment **EXPT**
- Solenoids **EXPT**
- Doorbells **EXPT**
- Floating Tube **EXPT**
- Jumping Ring **EXPT**
- Cool electromagnetic toys you can buy **EXPT**

Experiments with magnetic levitation

- How can you magnetically levitate objects?
- Donut magnets **EXPT**
- Levitating Train **EXPT**
- Spinning Copper Plate **EXPT**
- Superconductors **EXPT**
- Solenoids **EXPT**

- Floating Tube **EXPT**
- Floating Paper Clips **EXPT**
- Floating Pie Pan **EXPT**
- Suspended Objects **EXPT**
- Home-Built Magnetic Levitator **EXPT**
- Floating Ball **EXPT**
- Floating Plate **EXPT**
- Diamagnetic Levitation **EXPT**

Experiments with motors

- Generators
 - What happens when a wire moves with respect to a magnetic field? **EXPT**
 - Teathers in space
- Motors
 - What happens when a wire carrying current is within a magnetic field? **EXPT**
 - Types of Motors
- DC Motors **EXPT**
- AC Motors **EXPT**
- Linear Motors

Experiments with electronics

- Build your own Gaussmeter
- An inexpensive Gaussmeter **EXPT**
- A slightly more expensive Gaussmeter **EXPT**

- Modifications to the Gaussmeter **EXPT**
- Suspended Objects **EXPT**
- Home-Built Magnetic Levitator **EXPT**

Where to obtain the supplies and equipment

- Catalog houses and stores

Good books on magnets

- What are some good books on magnets?

Links to other sites on magnets

- Who else has cool stuff on magnets?

Live demonstrations

- Interested in having a live demonstration of the above exhibits?
- Professional background

Copy of the above exhibits

- If you are a museum or school interested in purchasing a copy of a hand-built exhibit similar to one seen on this web site, please drop me a note! I do not have ready made kits of these.

Additions or suggestions

- Do you have any additions or suggestions for other ideas or experiments that should be mentioned here or linked here? Let me know what you think. Drop me a note!
- If you would like to reference any of the information contained in this Magnet Man web site, please add the following to your bibliography or list of credits:
Hoadley, Rick. "Magnet Man". <http://my.execpc.com/~rheadley/magindex.htm> 1998-2003

Thank-you for being visitor number since June, 1998.

See a plot of the number of hits vs date since June, 1998.

Britannica.com has given this site a **THREE STAR** rating as The Web's Best Sites on magnets!

SciLinks selected the pages on Copper Pipes and the Pendulum as resource links.

Schoolzone has awarded this site "Highly Recommended for educational usefulness".





The Rick Hoadley Family "Home" Page

Welcome to the Rick and Sandy Hoadley home page.
Come on in, stay awhile, and meet the family.

Let us introduce ourselves!

- Visit our [church's home page](#)
 - Visit some interesting [links to other sites](#)
 - How can you become a [Christian](#)?
 - Want to see some cool experiments you can do with **magnets**? Check out [Magnet Man!](#)
 - Here are some cool [puzzles and toys](#) which don't use magnets, including pentominoes and executive toys.
 - Visit a link on creating clay models of cars and [automobile design](#)
-

What's new with the Hoadley Family?

Place for things in the future, such as a Family Tree, our Holiday Greetings, family member e-mail addresses, graduation photos, favorite links, etc.

You can send e-mail to the [Hoadley Family](#)

or, send an e-mail to [Rick at work](#)

This page last updated on 11/26/03

Thank-you for being visitor number since May, 2000.





What's New?

This page will keep you up to date on the changes to the Magnet Man site so you don't have to hunt and peck to see what's different!

Please note: the information at the end of several articles refers to the part number of that item at the source indicated. Arbor is [Arbor Scientific](#), Edmund is [Edmund Scientific](#), AS&S is [American Science and Surplus](#), EdIn is [Educational Innovations](#).

Future

(some possible additions in the future)

New toys that use magnets

Expand page on constructing the floating pie pan experiment

Expand page about levitating an aluminum sphere above a coil

Expand page about levitating an aluminum sphere between two coils

Expand page about the jumping ring experiment

How to make a magnetic can crusher

How to make a simple 3 phase ac motor drive

How to build an aluminum can motor

12/15/03

Added more photos of "[Make-Your-Own-Sculptures](#)"

Added photos of experiment showing [diamagnetic property of water](#)

Added photos of experiment with a [doorbell](#)

Added new patent and schools to [vita](#)

12/06/03

Added "Previous", "Home", "Next" links to the top of each page

Corrected some misspellings and other minor changes

Added links concerning [biomagnetic therapy](#)

Added [virtual physics link](#) to [links page](#)

Added another [virtual physics link](#)

Updated link on [maglev trains](#) (this has the info from <http://bmes.ece.utexas.edu/~jcamp/physics/>)

11/22/03

Added [Geomag toy](#)

Added [Joe Bender](#)

Added [diamagnetic levitator](#) page and to [toys](#)

Added [Amazing Magnets](#) as a source for [magnets](#)

Added "[Make-Your-Own Sculpture](#)"

Added "[Highly Recommended for Educational Usefulness](#)" award from [Schoolzone](#) to the [main page](#)

Added [Arabesk](#) link to [Executive Toys](#)

Updated the [hit chart](#)

Updated link to [Dowling Magnets](#)

07/05/03

Added search engine for web site

Filled in information on [Hall Effect](#) devices materials

Added a digit to the hit counter

Removed a dead link from magfield.htm

Updated the [hit chart](#)

02/22/03

Added page on [How do Magnets Work?](#)

Fixed link for [science fair project](#) on magnetic fields

Added links to [resources for teachers](#)

Added schematic for the [simple gaussmeter](#)

02/02/03

Added the [Home-Built Magnetic Levitator](#)

Added a big list of [uses for magnets and electromagnets around the house and car](#)

Added more photos and text about the [simple AC motor](#)

Added link to a [commercial magnetic levitator](#) on [page](#)

12/26/02

Added an [Easy Electromagnet Experiment](#)

Added [Make a Speaker!](#)

Added a link to the [Pentominoes](#) page

Cleaned up the schematics for the [gaussmeter](#) and [options](#)

12/19/02

Added the [Ball Bearing Launcher](#) experiment

11/29/02

Added links to [amazon.com](#) for books on magnets

Added link to the [Magnet Shop](#) in Australia

Added SciLink to the page describing the [pendulum](#) experiment

Added info on [FREE Student Version of Ansoft's Maxwell 2D software](#)

Added info on collecting [micrometeorite dust](#)

Corrected some of the hypertext links and spellings

11/28/01

Corrected spelling errors (clever, not cleaver!)

Added a couple of new links about magnetic suspension and [sculptures](#)

Added links for high [voltage kits](#) and for [software for simulating electrical circuits](#)

Additional information on where to find [magnesium](#)

(Thank you to those who have written with the above suggestions and corrections!)

By the way, it appears that the link to <http://bmes.ece.utexas.edu/~jcamp/physics/> is no longer active. This was an excellent site. I'll try to see if it has been moved to another location or if I can publish a copy of it.

04/20/01

Added SciLink to the page describing the [copper pipes](#) experiment

Updated [chart](#) showing number of hits

Added photos and descriptions of more [DC motors](#)

Added photos of "The Plank" to [Electromagnets](#)

Added photo of a solenoid from a dishwasher to [Solenoids](#)

Added photos of battery powered electromagnet to [Cool Electromagnet Toys](#)

Added photos of dissecting a speaker to [Electromagnets](#)

Added photos of a Jacob's Ladder in a box to [Electromagnets](#)

Added photos of using BBs to measure the [strength of magnets](#)

Added photos of the [Levitron Perpetuator](#) working

Added photos of a [Perpetual Calendar](#) using magnets

Added photos of unusual configurations with [superconductors](#)

Added photos of the [Zero Gravity Levitator](#) toy, [here](#) too

Added photos of a demo of [Fleming's Left Hand Rule](#)

Added photos of transformer action using [AC electromagnets](#)

Added info on the [sun's magnetic field](#) flipping every 11 years at the peak of the sunspot activity

Added photo on an [Atomic Clock](#)

01/01/01

Fixed patent links since the site changed from ibm to delphion.

Expanded and modified page on [inexpensive Gaussmeter](#).

Showed the three pages of Gaussmeter information on the [magindex.htm](#).

Added link to <http://www.greatsouth.net/> for minerals on [What is attracted to magnets?](#)

12/22/00

Added photos of [Meissner](#) effect.

12/15/00

Greatly expanded page on [What is magnetism?](#)

Added page on [What types of magnets are there?](#)

Added page on [What affects the strength of a magnet?](#)

Expanded page on [What is near the Geographic North Pole, ...?](#)

Expanded page on [Magnetism in space](#)

Added page on [Is there free energy in magnets?](#)

Greatly expanded page on [What is attracted to magnets?](#)

Greatly expanded page on [How strong are magnets?](#)

Greatly expanded page on [What do magnetic fields look like?](#)

Added page on [Magnet math](#)

Added page on [Magnetism and biology](#)

Expanded page on [Superconductivity](#)

Added page on [Solenoids](#).

Greatly expanded section on Experiments with motors

Added an item to the [Pentominoes](#) page.

Added some more cool new items to the end of the page of [Executive Toys](#).

Added info on [brushless DC motors](#) and fixed link on page.

Added the **EXPT** key to items that have experiments you can buy or build.

I think I touched just about every page.

7/23/00

Added some cool new items to the end of the page of [Executive Toys](#).

5/23/00

Corrected the hit counter. Added 40,000 to the present number.

Fixed the link to <http://www.oz.net/~coilgun/levitation/home.htm>

4/9/00

Added link to the list of sites on [AC motor design](#)

Noted change in the hit counter. It was reset sometime in March 2000.

2/19/00

Added the page on [Types of Magnets](#).

Added the three navigation boxes (previous page, home page, next page) to each page. So now you can visit every page in this site by clicking on the "NEXT" button at the bottom of each page. (Hope you like those horseshoe magnets!)

Removed a dead link.

Added to list of ways to [levitate objects](#).

12/3/99

Added some great [links](#) to sites on the science of magnets, how to design magnets, and magnetic glossaries.

Added another link to show the [North and South](#) poles of Earth.

Added link to a handbook on [Copper Pipes](#) (Tubes).

11/12/99

Added science fair project information to page on [How strong are magnets?](#)

Added project information to page on [Suspended Objects](#).

Added a few more choice [links](#) to the list, again.

11/11/99

Added items to [Executive toys without magnets](#), including a Jacob's Ladder and Drinking Bird.
Added items to [Cool toys you can buy](#).
Added a section on magnetic minerals to [What's attracted to magnets?](#).
Added an improvement to [Magnetic Plumb](#).
Added page and links on [Magnetism in space](#).
Added pages and links on [AC and DC motors](#). Important addition! Don't miss this!
Added several [books](#) to the list.
Added a few more [links](#) to the list, too.
Added a couple of [field](#) views to the list and a link with animated fields.

4/18/99

Added this page on What's New.
Added photos of [large floating donuts and other smaller donuts](#).
Added free [magnetic field FEA](#) link.
Added links on [Suspended Objects](#).
Added link to [pioneers in electromagnetism](#).
Added link to [science museums](#).
Added link to [Magnetic Formulas](#).
Added photo of another chaotic pendulum, [ROMP](#).
Added photo of [magnetic sculpture toy](#).

4/10/99

Added page on [Modifications to the Gaussmeter](#).

3/25/99

Added bio to the Demo page.
Added link to "How Strong are Magnets?" page.
Added links to "Who else has cool stuff on magnets?" page.

3/22/99

Added page on building a Gaussmeter.

2/16/99

Added information on where to obtain items for levitating train.
Added links to "Suspended Objects" page.
Modified links page.

12/22/98

Added pages on pentominoes, puzzles and executive toys without magnets.
Added more magnetic toys to the other pages.

12/8/98

Added links to pages on earth's magnetic poles and material attractions.

10/24/98

Modified reference to Grolier Encyclopedia.
Added link to future Gaussmeter page.

8/18/98

Added plots of fields from simulation program, Ansoft.

6/20/98

Put Magnet Man page on the net.





Number of visits to this Magnet Man web site

Number of hits since June, 1998

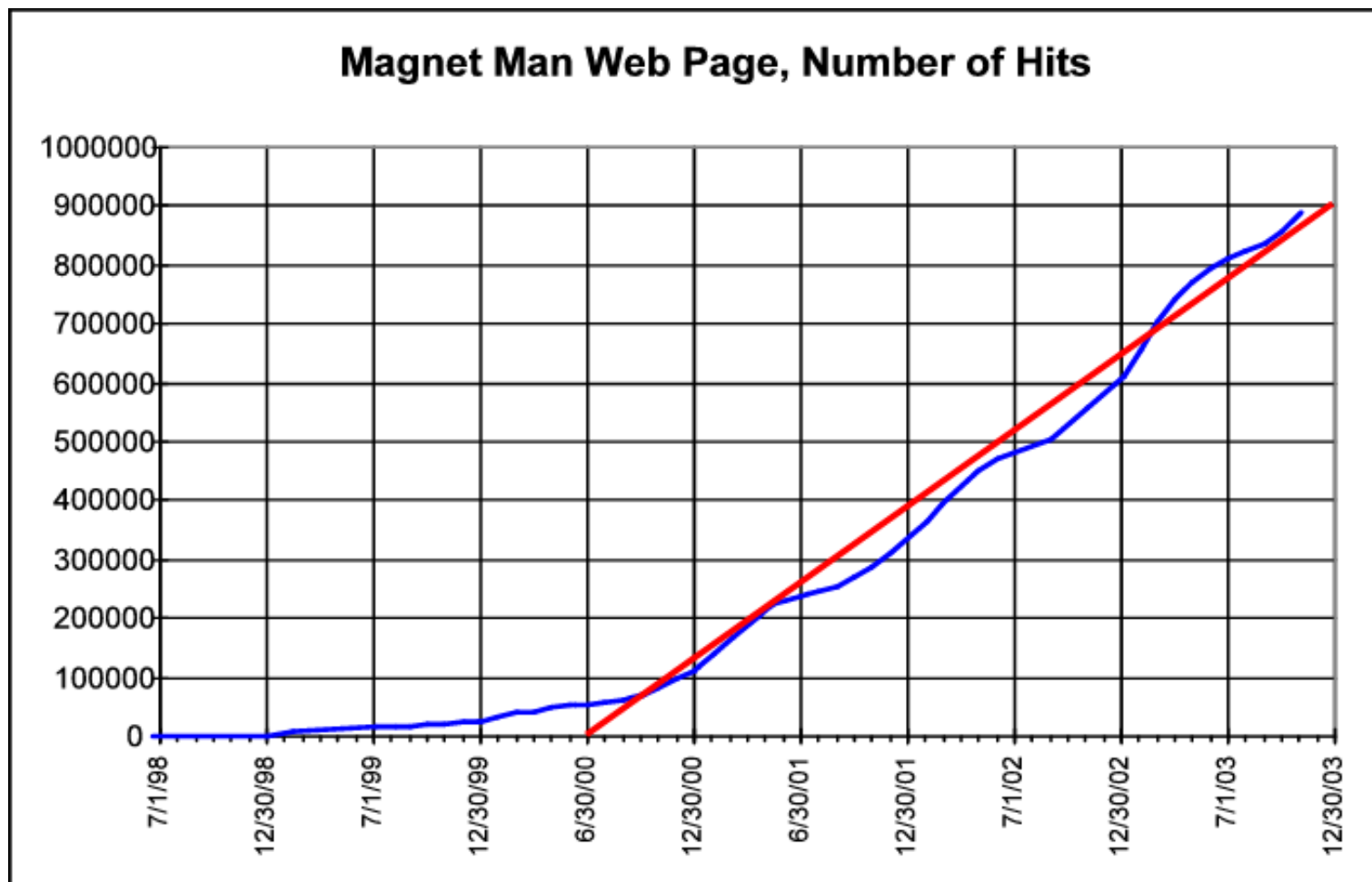

Thank-you for your visits! I hope that you are learning something new.
If you have some ideas that would help make this site more interesting, [please let me know!](#)
I've incorporated most of the suggestions sent in.





Live demonstrations

Interested in having a live demonstration of the above exhibits?

If you are in the Milwaukee, Wisconsin area and are interested in scheduling a live demonstration of the above exhibits with a talk about all these cool things you can do with magnets, please contact me via [e-mail](#). The demonstration can be customized to fit your time schedule, anywhere from 30 minutes to 90 minutes, depending on what exhibits would be shown and the age of the audience. It is suitable for grades 4 through 12, Cub Scouts, Boy Scouts, Girl Scouts, engineering college students, after dinner talk for a company function, or anyone with an interest in physics.

Professional Background

Mr. Rick Hoadley of [Rockwell Automation](#) ([Allen-Bradley](#)) will demonstrate many of the “Cool Experiments with Magnets” described on his web site at <http://my.execpc.com/~rroadley/magindex.htm>. Among the hands-on experiments are various methods of levitation using permanent magnets and eddy currents. Several of the executive toys using magnets will also be shown for you to try out. These experiments have been shown to several student groups as a method to learn more than just the basics about magnets and magnetism. Until recently, most of the experiments were either not possible or too expensive for classrooms since powerful Neodymium-Iron-Boron permanent magnets were not readily available. Simulations of magnetic fields using Ansoft’s Maxwell 2D Field Simulation program will also be shared.

Rick Hoadley received the B.S. and M.Eng. degrees in electrical engineering from [Cornell University](#), Ithaca, NY, in 1973 and 1974, respectively. From

1974 to 1987, he had been involved with product development of AC and DC motor drives with Borg-Warner Power Electronics in Ithaca, NY, and the Seco Division of Warner Electric Brake and Clutch in Charlotte, NC. Since 1987, he has been with the Rockwell Automation/Allen-Bradley Co. in Mequon, WI, where he has held management positions with their Configured Drives group, Drives Systems group, Drive Systems Product Development group and Standard Drives Development group. His interests include adjustable speed drives, drive applications, magnets, and teaching engineering.

Rick has authored and presented several papers on AC drive applications at Powercon, AISE, PCIM, IEEE/PCIC, IEEE/IAS and for Allen Bradley's seminars and publications, and holds patents [4,521,840](#) and [6,657,322](#) associated with AC drives.

He is an alumnus of the [Bad Godesberg American School on the Rhine](#) in Bad Godesberg, Germany; [Aiglon College](#) in Chesieres-Villars, Switzerland; [Dearborn High School](#) in Dearborn, Michigan; and [Cornell University](#) in Ithaca, NY.

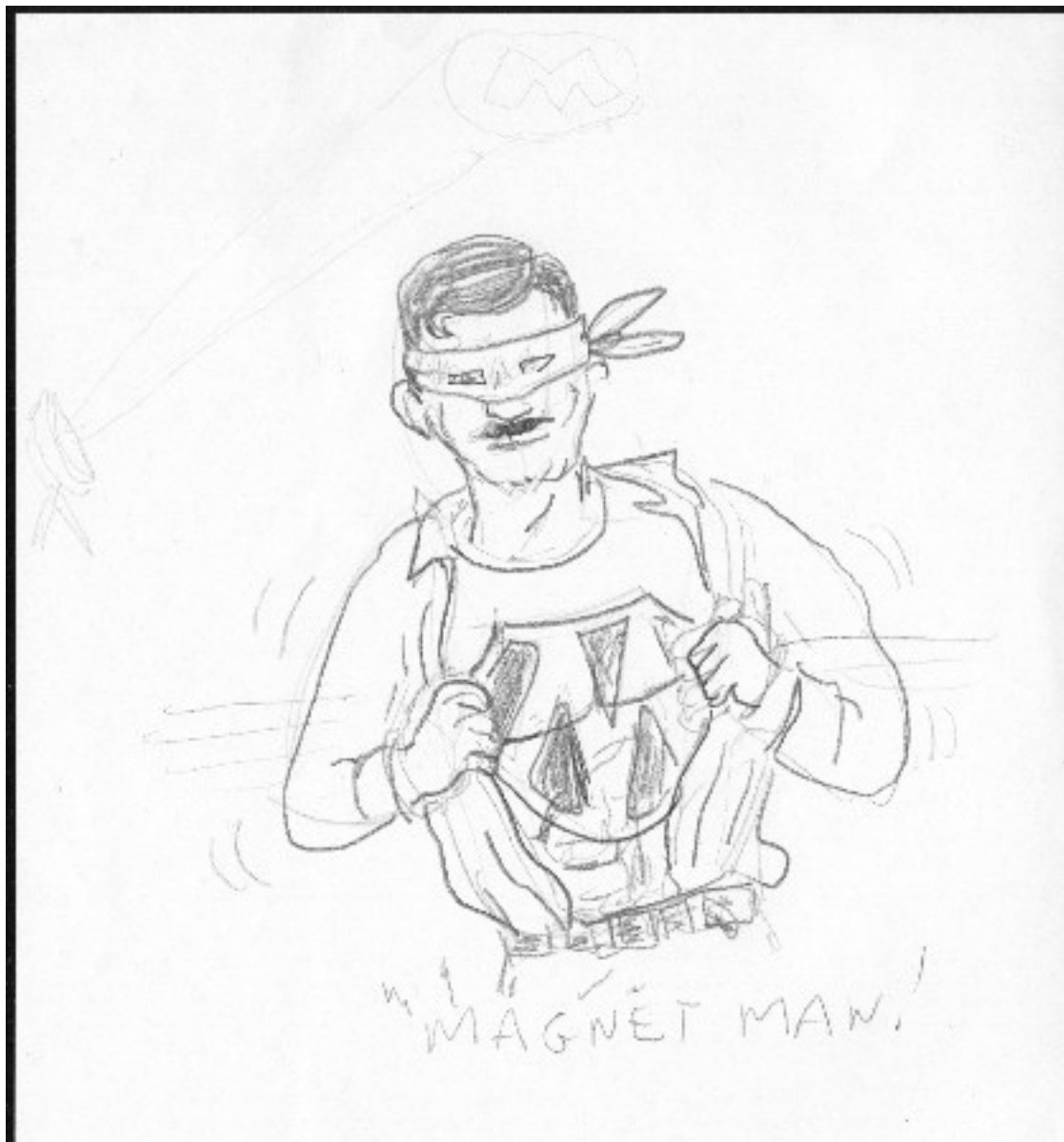

A sketch of Magnet Man by Dick Soliva!



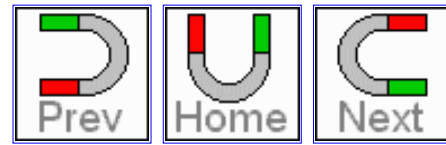

Links to other sites on magnets

Who else has cool stuff on magnets?

Magnetic Levitation

www.calpoly.edu/~cm/studpage/clottich/fund.html
<http://www-hfml.sci.kun.nl/hfml/levitation-possible.html>
<http://tech.dep.anl.gov/act/maglev.html>
<http://www.physics.ucla.edu/marty/diamag/>
<http://scitoys.com/scitoys/scitoys/magnets/suspension.html>
<http://www.magmotor.com/maglev/index.html>
<http://www.geocities.com/Area51/Shire/3075/maglev.html>
<http://www.amasci.com/maglev/maglev.html>

Magnet Demonstrations

<http://www.eskimo.com/~billb/neodemo.html>
<http://www.netcomuk.co.uk/~ww1/neodym.html>
http://www.netroglycerine.com/education_and_training.html
<http://www.howstuffworks.com/electromagnet.htm>
<http://freeweb.pdq.net/headstrong/mag.htm>
<http://sprott.physics.wisc.edu/demobook/chapter5.htm>

Resources for Teachers

<http://www.exploratorium.edu/snacks/iconmagnetism.html>
http://www.geo.umn.edu/orgs/irm/hg2m/hg2m_index.html
<http://www.galaxy.net/~k12/electric/index.shtml>
<http://www.scitoys.com/scitoys/scitoys/magnets/magnets.html>
<http://www.sciencejoywagon.com/physicszone/lesson/08magnet/default.htm>
<http://www.school-for-champions.com/science/magnetism.htm>
<http://school.discovery.com/lessonplans/programs/understanding-magnetism/>
<http://buphy.bu.edu/~duffy/electricity.html>
<http://www.pausd.palo-alto.ca.us/k6science/electric/electric.html>
<http://www.sasked.gov.sk.ca/docs/elemsci/gr4ueesc.html>
<http://www.utm.edu/departments/ed/cece/second/2B2.shtml>
http://news.nationalgeographic.com/news/2003/01/0106_030106_lobster.html
<http://earthview.sdsu.edu/trees/mag.html>
<http://www.schoolzone.co.uk>
<http://education.jlab.org/beamsactivity/6thgrade/magnetsandelectromagnets/>

Other Physics Demos

<http://www.eskimo.com/~billb/scied.html#demo>
<http://www.shef.ac.uk/chemistry/web-elements/index-fr.html> (periodic table of elements)
[Physics Demonstrations, A Sourcebook for Teacher of Physics](#) by Julien C. Sprott
<http://www.amazing1.com/voltage.htm> for some high voltage kits and experiments, using magnetic fields

Virtual Physics Labs

<http://micro.magnet.fsu.edu/electromag/java/> great site for playing with magnets using the computer as a lab

<http://www.phys.hawaii.edu/~teb/java/ntnujava/index.html> has other physics stuff with java

Electricity and Magnetism

<http://yara.ecn.purdue.edu/~smag/>

<http://www.science-tech.nmstc.ca/mainindex.cfm?idx=1367&language=english&museum=sat&function=link&pidx=1367>

Magnets

<http://www.microweb.com/nature/dowling.html>

<http://www.stanfordmaterials.com/magnet.html#ntb>

<http://nyelabs.kcts.org/>

<http://www.adamsmfg.com/novelty.htm#novelty>

The Science of Magnets, How to Design Magnets, Glossary of Magnetic Terms (great sites to learn about Magnets!)

<http://www.magnetsales.com/>

http://www.magnetsales.com/design_guide.html

<http://www.magnetsales.com/glossary.html>

<http://www.dextermag.com/pmp.htm>

[Introduction to Magnetics](#)

[The Science of Magnets](#)

[Magnetic Design](#)

<http://www.grouparnold.com/mtc/index.htm>

<http://www.grouparnold.com/mtc/manuals.htm>

<http://www.grouparnold.com/mtc/glossary/index.htm>

<http://www.stanfordmaterials.com/magnet.html>

<http://www.stanfordmaterials.com/magnet.html#glos>

Mr. Magnet

<http://www.foe.er.doe.gov/slide.html>

Discovering Electricity and Magnetism

<http://www.ronkurtus.com/physicien/magnetism.htm>

<http://www.magnet.fsu.edu/>

http://www.newton.mec.edu/brown/mag-lev_links.html

<http://www.newi.ac.uk/BUCKLEYC/magnet.htm>

<http://www.ee.surrey.ac.uk/Workshop/advice/coils/terms.html>

<http://www.wiretron.com/>

<http://www.oz.net/~coilgun/sitemap.htm>

Have a question?

<http://www.askanexpert.com/>

<http://k12.magnet.fsu.edu/>

<http://k12.magnet.fsu.edu/FAQ/index.html>

Pioneers in Electromagnetism

<http://www.ee.umd.edu/~taylor/frame1.htm>





Experiments with magnets and our surroundings

Cool magnetic toys you can buy EXPT

Please note: the information at the end of each article refers to the part number of that item at the source indicated. Arbor is [Arbor Scientific](#), Edmund is [Edmund Scientific](#), AS&S is [American Science and Surplus](#), EdIn is [Educational Innovations](#).

Magnetic Marbles



These are plastic marbles or balls which have a magnet in them so that they will stick to one another. You can make some interesting shapes with them. They cost only about \$4 for 20 marbles.

Arbor P8-1122, Edmund 34-968, AS&S , EdIn M-620

Mysterious Magnet Tube



This is a great device to help see magnetic fields. It is a tube within a larger tube, containing iron filings. Place a magnet inside the smaller tube and

shake the filings around to see how they form on the magnet. If you place another magnet inside, you'll see the opposing fields form. This is a super toy! It even comes with a real cow magnet. From [Dowling Magnets](#). Cost is only about \$12.

Arbor , Edmund 52-976, AS&S , EdIn

Magnetic Field Viewer



This is another great device to help you see magnetic fields. It is a thin film containing powdered iron and a green oil. Place the film onto a magnet and see where the poles are located and the line between the poles. You can easily see the strips of N and S poles on the back of inexpensive refrigerator magnets! The way it works, is that either a North pole or a South pole will appear very dark green, almost black. The line which divides the North from the South poles appears very light green, almost white. This way, you can see how many N and S dividing lines there are. From [Arbor Scientific](#). Cost is only about \$2.50.

Arbor P8-1152, Edmund 33-447, 37-906, AS&S , EdIn M-555

Iron Filing Case



This is similar to the mysterious magnet tube, but flat. It is a thin plastic box with iron filings in it. Place a magnet onto the surface of the box and see the fields appear. The plastic box keeps the filings contained, which is real nice! Cost is only about \$2. From [American Science and Surplus](#). The third photo is similar but has pink sand mixed in with the iron filings. Placing a magnet on it will allow you to separate the iron from the sand. Also cost about \$2, from [Educational Innovations](#).

Arbor , Edmund , AS&S 91408, EdIn M-610, EdIn M-615

Magnetic Wands



These wands are popular items in several stores. They are fairly strong and are great to demonstrate the attraction between unlike poles and the opposition between like poles. They also work well to see what objects are attracted to magnets. Cost is about \$2-\$3 each. (Just don't get them close to the screen of a color TV! You'll see more colors than you want, and they won't go away easily!)

Arbor P8-1165, Edmund , AS&S , EdIn M-510.

Here are some tips on how they interact with each other:

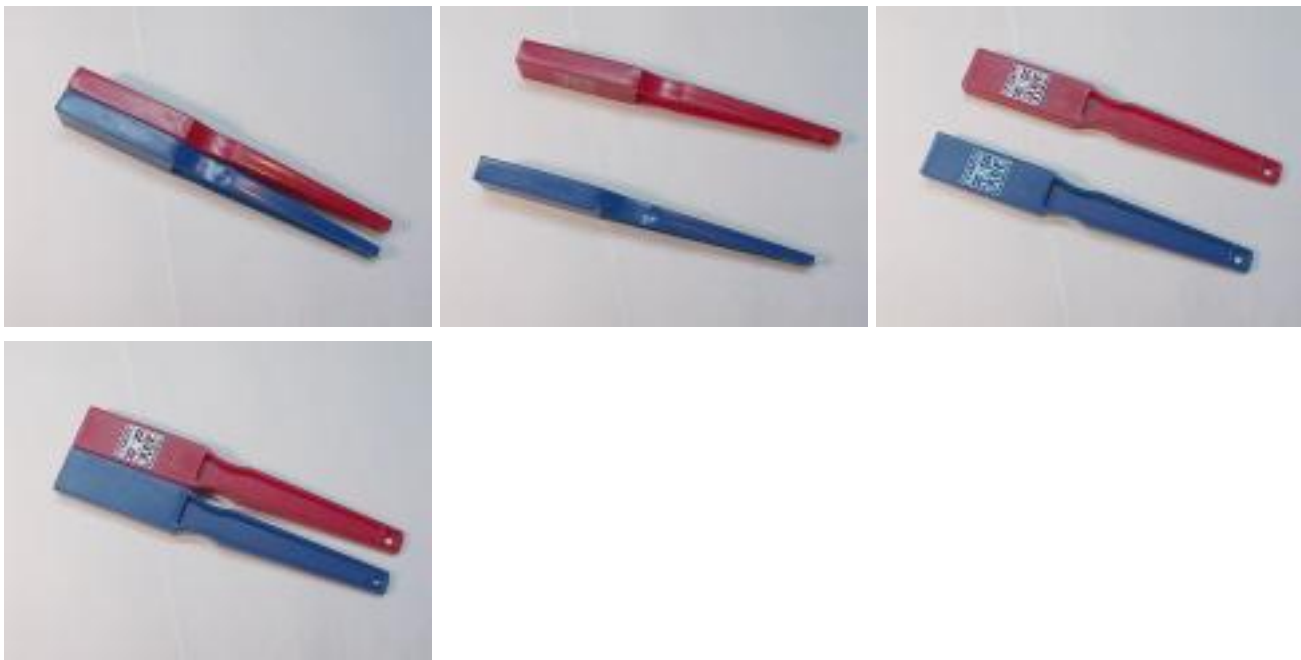

First photo is where they are attracted to each other, North to South. The large flat faces are the strongest areas of the wand magnets.

Second photo is where they are repelled by each other, South to South.

Third photo is where both of their South poles are facing up, and they don't want to stick. The sides are weaker than the faces.

Fourth photo is where red is South up and blue is North up, so they stick.



Fifth photo is like the third, both of their South poles are facing up, and they don't want to stick. The ends are the weakest part of the magnet.

Sixth photo is like the fourth, red is South up and blue is North up, so they stick very weakly.

Seventh photo shows how a magnet can pick up a bar of steel. It only works with the large flat face, not the sides nor the end.

Eighth photo shows how the wand magnet can be modified to be very strong on the end, easily

picking up the bar of steel. Just strap or tape or rubber band two pieces of steel onto the flat faces of the magnet. This re-directs the magnetic flux to the end of the magnet where the steel bar is located. The wand magnet is very strong this way!

Magnetic Sculptures



There are several types of magnetic sculptures where you have two strong permanent magnets in a base and shapes of iron pieces (temporary magnets) which stick to one another and the base. You can form them into towers, bridges, etc. The one on the right is called Magnetic Magic from Carlisle Co (1-800-233-3931).

Arbor , Edmund 81-985, AS&S , EdIn

Roger's Connection



This is a clever toy which uses magnets at each end of the black plastic tubes and steel balls to form various geometrical shapes. The photo on the right shows how you can even magnetically suspend a structure and spin it. From [Roger's Connection](#). Cost is about \$36, but it is a well constructed kit of parts.

Arbor , Edmund , AS&S , EdIn

Geomag or Supermag



These kits are very similar to Roger's Connection. The construction of the plastic connectors that hold the magnets is better than the other, but they are a lot shorter. Nice thing is that the plastic connectors come in different colors and that there are two sizes of them. Cost is still kind of high, but they are fun to play with. They can be found in Zany Brainy and many other stores. A couple of other sources are www.plastwoodusa.com and www.geomags.com. A kit of 50 pieces, (magnetic connectors plus steel balls) is about \$22.

Arbor , Edmund, AS&S , EdIn

Make-Your-Own Sculptures



You can buy a bunch of magnets and steel balls and make your own sculptures! Be creative! I had these three steel balls, 1.875" diameter (and weigh 1 lb each), and some NIB magnets sitting around. The grouping on the left is using magnets measuring 3/8" long, 1/2" dia, with a 1/4" hole in the center. The grouping on the right is using magnets measuring 1/8" thick, 3/4" dia, with a 7/16" hole in the center. I kind of like the one on the right more. What I want to do next is buy a few more balls and magnets and add to it. The balls cost about \$3.25 each from AS&S. Everybody at work likes to pick this up and see if they can pull the balls apart. This is what I call a "heavy-duty" sculpture.



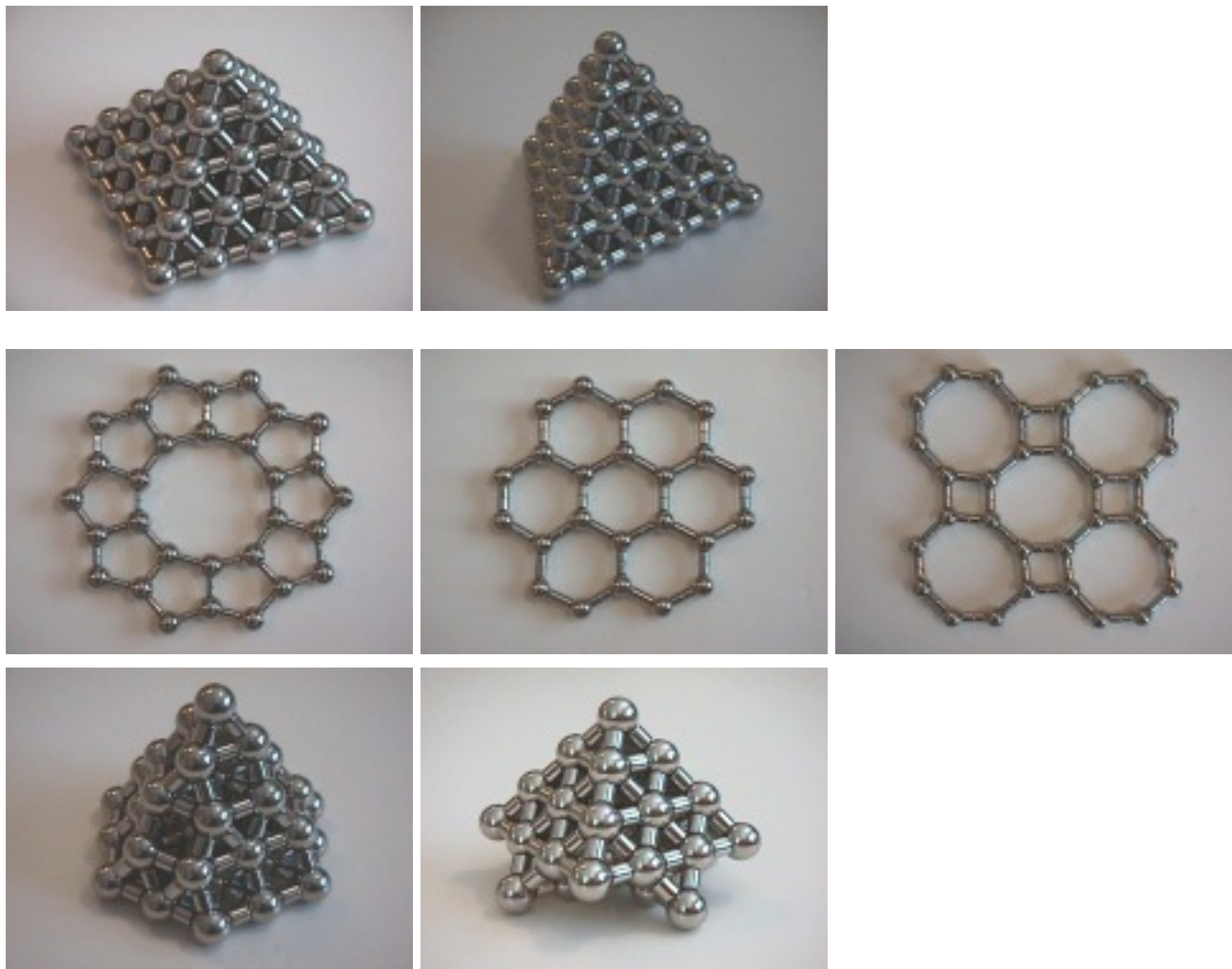

If you want, here's a site that puts kits of magnets and balls together for you. They have some great stuff at www.amazingmagnets.com. These photos show some of the things I was able to do with their kits, like the superbball and the 6 pointed star and some 3/4" balls and spherical magnets. The superbball I am holding is simply an [icosahedron](#) or a [stellated dodecahedron](#) (20 equilateral triangles arranged in groups of 5, like the first photo in this grouping showing two of them) using fancy triangles. This is great fun!

In order to plan for how many balls and magnets you will need, use this table for the cube, square pyramid (like the Egyptian pyramids) and the triangular pyramid. The number of layers refers to the number of balls along the edge of the shape. For example, the cube shown in the photo above has 3 cubes along each side, but has 4 balls along each edge, so it is a cube with 4 layers. The square pyramid shown has 5 layers. The triangle pyramid shown has 6 layers.

Number of Layers	Cubes		Square Pyramid		Triangle Pyramid	
	balls	magnets	balls	magnets	balls	magnets
1	1	0	1	0	1	0
2	8	12	5	8	4	6
3	27	54	14	36	10	24
4	64	144	30	96	20	60
5	125	300	55	200	35	120
6	216	540	91	360	56	210
7	343	882	140	588	84	336
8	512	1344	204	896	120	504

Arbor , Edmund, AS&S , EdIn

Joe Bender

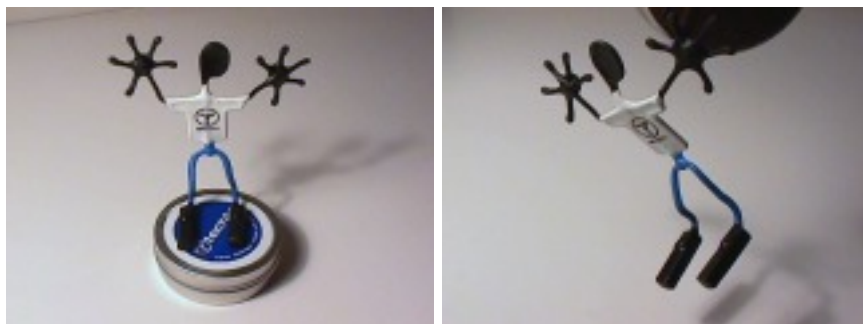

This is another fun toy which uses magnets on each hand and foot so that you can twist the poor fellow around and hang him from a hand or foot from any steel structure. They come in all sorts of outfits and colors. When you buy them, they are all folded up within the can shown in the photo on the left. This was a freebie, but they usually cost about \$10. Available at www.toymagnets.com/desk_toys/index.cfm.

Arbor , Edmund , AS&S , EdIn

Magnetic Space Wheel



This toy has been around since the 1960's, maybe before! It is a clever toy which uses a magnet as an axis for the wheel, keeping it in contact with the wire frame which acts as a track. The wheel follows the track around on the inside and outside of the frame. From [Action Products International](#). Cost is about \$4

Arbor , Edmund 81-795, AS&S 91608, EdIn

Wizmo XT



This is the updated version of the space wheel, where XT means extra long. There is even an "Executive" version, with a black handle and chrome wheel! Cool! Cost is about \$10.

Arbor , Edmund , AS&S , EdIn

Spiraculum



A variation on the theme. Clever design. The wheel can roll on the outside

of the spiral or between the center rod and the spiral. Cost is about \$45.

Arbor , Edmund , AS&S 91668, EdIn JV-200

Similar units called Explorer and Spiral Spinner from Edmund 82-285, 82-283

Orbitron



Another variation where the wheel rides on the outside of the wheel. Cost is about \$15.

Arbor , Edmund , AS&S , EdIn

A larger, similar unit called Revolution from Edmund 82-284

Magnetizer / Demagnetizer



Just pull your screwdriver through the center to magnetize it, or scrape it along the outside to demagnetize it. Works well! Cost is about \$4.

Arbor , Edmund 81-665, AS&S , EdIn

Horseshoe Magnet



A horseshoe magnet of Alnico, great for small experiments. Please note the keeper on the end of the magnet - needed to help prevent the magnet from becoming demagnetized. Cost is about \$4.

Arbor , Edmund , AS&S , EdIn

Magnetic Pick-Up Tool



A very handy telescoping tool with a strong NIB magnet on the end. Great for picking up something that may have fallen into a tight place. Remember, if the walls of the tight place is steel, this won't help much. Cost is about \$5.

Arbor , Edmund , AS&S , EdIn

Magnetic Mysteries Set



This is a super kit of magnets, coins, magnetic viewing film, a ball bearing and steel plates! It came with a very well written booklet full of interesting experiments. This is a great buy from [Arbor Scientific](http://www.arbor.com). Cost is about \$30.

Arbor P8-1155, Edmund , AS&S , EdIn

Magic Pennies



Another great kit with two magnets and several British one pence and two pence coins. Great booklet with several experiments and tricks. Cost is about \$22.

Arbor , Edmund 81-463, AS&S , EdIn

Magnet Man



How about that? A fridge magnet in the shape of a man which doubles as a clip! From Ace Hardware. Cost is about \$2.

Arbor , Edmund , AS&S , EdIn

The Funny Thing Oscillator



This item is almost a one of a kind. I was browsing through Edmund Scientific's retail store in Barrington, NJ, when I came across this. It is similar to the MagnaSwing, but is more versatile. Essentially you have a coupled oscillator using the two arms made of spring steel. The magnets on

the arms affect the oscillation frequency, and also provide repulsion between them. There is plenty of physics involved here. This is a copyrighted sculpture, 1997, by Funny Things, Ltd. Cost is about \$25.

Arbor , Edmund 81-401, AS&S , EdIn

Luna Balls



This has some clever experiments for you to try. There are 4 balls, each a different size, each magnetized. The way they interact is not always what you'd expect. From Edmund. Cost is about \$2.

Arbor , Edmund 60-508, AS&S , EdIn





Magnet basics

What is magnetism?

What is a magnet?

A magnet is an object made of certain materials which create a [magnetic field](#). Every magnet has at least one north pole and one south pole. By convention, we say that the magnetic field lines leave the North end of a magnet and enter the South end of a magnet. This is an example of a magnetic dipole ("di" means two, thus two poles). If you take a bar magnet and break it into two pieces, each piece will again have a North pole and a South pole. If you take one of those pieces and break it into two, each of the smaller pieces will have a North pole and a South pole. No matter how small the pieces of the magnet become, each piece will have a North pole and a South pole. It has not been shown to be possible to end up with a single North pole or a single South pole which is a monopole ("mono" means one or single, thus one pole).

<http://encarta.msn.com/find/Concise.asp?ti=004AD000>

History

The ancient Greeks and Chinese discovered that certain rare stones, called lodestones, were naturally magnetized. These stones could attract small pieces of iron in a magical way, and were found to always point in the same direction when allowed to swing freely suspended by a piece of string. The name comes from Magnesia, a district in Thessaly, Greece. For more history, check <http://www.newi.ac.uk/BUCKLEYC/magnet.htm>

Several scientists from the 1600s to today have greatly increased our understanding of magnets and their properties. Be sure to check:

<http://www.worldwideschool.org/library/books/hst/biography/FaradayasaDiscoverer/toc.html>

<http://www.ee.umd.edu/~taylor/frame1.htm>

<http://www-istp.gsfc.nasa.gov/Education/whmfield.html>

Ferromagnetism

When a ferromagnetic material is placed near a magnet, it will be attracted toward the region of greater magnetic field. This is what we are most familiar with when our magnet picks up a bunch of paperclips. Iron, cobalt, nickel, gadolinium, dysprosium and alloys containing these elements exhibit ferromagnetism because of the way the electron spins within one atom interact with those of nearby atoms. They will align themselves, creating magnetic domains forming a permanent magnet. If a piece of iron is placed within a strong magnetic field, the domains in line with the field will grow in size as the domains perpendicular to the field will shrink in size.

Diamagnetism EXPT

When a diamagnetic material is placed near a magnet, it will be repelled from the region of greater magnetic field, just opposite to a ferromagnetic material. It is exhibited by all common materials, but is very weak. People and frogs are diamagnetic. An interesting experiment showing this is at <http://www.sci.kun.nl/hfml/froglev.html> where a frog is levitated at the top of a very strong electromagnet. Metals such as bismuth, copper, gold, silver and lead, as well as many nonmetals such as graphite, water and most organic compounds are diamagnetic.



For example, here are some photos of a very strong neodymium-iron-boron magnet sitting in a dish with a shallow amount of water covering the magnet. Looking at the reflection of the light above the sink off of the surface of the water, you can see how the reflection is distorted because the

water is concave just above the magnet, and flat everywhere else. (The fuzzy object in the two photos on the right is the magnet; the camera is focused on the reflected light.) This is because the magnet has pushed the water away since water is repelled by strong magnetic fields.

Also check http://www.exploratorium.edu/snacks/diamagnetism_www/index.html

Here's a [fixture](#) using diamagnetic disks that you can purchase and experiment with.

Paramagnetism

When a paramagnetic material is placed near a magnet, it will be attracted to the region of greater magnetic field, like a ferromagnetic material. The difference is that the attraction is weak. It is exhibited by materials containing transition elements, rare earth elements and actinide elements. Liquid oxygen and aluminum are examples of paramagnetic materials.

What are magnets used for?

This is a question I'll let you answer. There are hundreds and hundreds of uses which you will discover here at "Magnet Man" and in the links. Yes, some are used to hold the family's schedule and photos onto the refrigerator door, but that is just one use for magnets. Magnets were first put to use to help navigate since they would always point in a North / South direction, no matter what the weather was. Daniel Boone once said, "**I can't say I was ever lost, but I was bewildered once for three days.**" Perhaps if he had a compass, his bewilderment would have only lasted a few hours!

For the most part, magnets are used to hold, separate, control, convey and elevate products and to convert electrical energy into mechanical energy or convert mechanical energy into electrical energy.

Some more unusual uses for magnetism are:

[refrigeration](#) (see also [Patent #4107935](#))

bending an electron beam or proton beam in a synchrotron

Here's a list of things I've found around the house and in the car that uses magnets or electromagnets to make them work:

Around the house:

Headphones
Stereo speakers
Computer speakers
Telephone receivers
Phone ringers
Microwave tubes
Doorbell ringer solenoid
Refrigerator magnets to hold things
Seal around refrigerator door
Plug-in battery eliminators
Floppy disk recording and reading head
Audio tape recording and playback head
Video tape recording and playback head
Credit card magnetic strip
TV deflection coil
TV degaussing coil
Computer monitor deflection coil
Computer hard drive recording and reading head
Dishwasher water valve solenoid
Shower curtain weights / attach to tub
Power supply transformers

Motors for use in:

CD spinner and head positioner
DVD spinner and head positioner
Audio tape transport
VHS tape transport
VHS tape loader
Microwave stirring fans
Kitchen exhaust fans
Garbage disposal motor
Dishwasher
 Pump
 Timer
Refrigerator
 Compressor
 Ice maker dumper
Sump pump
Furnace
 Blower
 Exhaust
Garage door opener
Clothes washer
 Pump and agitator
 Timer

- Clothes dryer
 - Timer
 - Drum turner
- Bathroom exhaust fan
- Electric toothbrush
- Ceiling fan
- Pager or cell phone vibrator
- Clocks (not the wind-up type or LCD type)
- Computer
 - Cooling fans
 - Floppy disk spinner
 - CD spinner
 - DVD spinner
 - Hard disk spinner
- Can opener
 - Motor
 - Lid holder magnet

Things in the Car:

- Starter motor
- A/C clutch
- Interior fan motor
- Electric door locks
- Windshield wiper motor
- Electric window motor
- Side-view mirror adjuster motor
- CD player motor
- Audio tape player motor
- Audio tape recorder and playback heads
- Engine speed sensors
- Alternator
- Starter relay
- Windshield washer pump motor

Can you find more?

How to find out more

To learn more about [magnets](#) and magnetism, you should spend some time reading articles about magnets in encyclopedias at home or on the [web](#), other related [websites](#) and other [books](#). When looking for articles, here are some suggestions for keywords you can use in a search:

- magnets

- permanent magnets
- magnetics
- magnetism
- electromagnetism
- magnetic field
- dipole
- Helmholtz coil
- magnetic moment
- diamagnetism
- paramagnetism
- ferromagnetism
- ferrimagnetism
- antiferromagnetism
- levitation
- suspension
- Gilbert
- Faraday
- Lenz
- Oersted
- Maxwell
- Henry

- Langevin
- a [glossary](#) of magnetic terms

There is also a very nice review of magnetism found in the [1998 Grolier Multimedia Encyclopedia](#) which may have been included in the pack of software applications that came with your computer.





Experiments with electromagnets

Solenoids

Description:

A solenoid is simply a coil of wire connected to a DC or AC voltage source. It is just like an electromagnet, except it has an air core.

Construction: EXPT



The construction would be the same as the [DC electromagnet](#) or [AC electromagnet](#). The difference would be that instead of inserting a 3/4" diameter iron bolt into the middle of the coil, place a 2" long 1/4" bolt part way into the core, letting the bolt rest on the table as shown. The power can come from connecting it directly to the output of a variac, or by connecting the output of the variac to a diode bridge, and connecting the coil to the DC output terminals of the diode bridge. To smooth out the DC output, a capacitor can be connected in parallel with the coil. I prefer the DC connection since the coil is stronger without the AC impedance created by the varying voltage.

Demonstration:



As shown here, the power is turned on, causing the 1/4" bolt to be pulled into the middle of the air core of the solenoid. When the power is turned off, the bolt drops to the table.

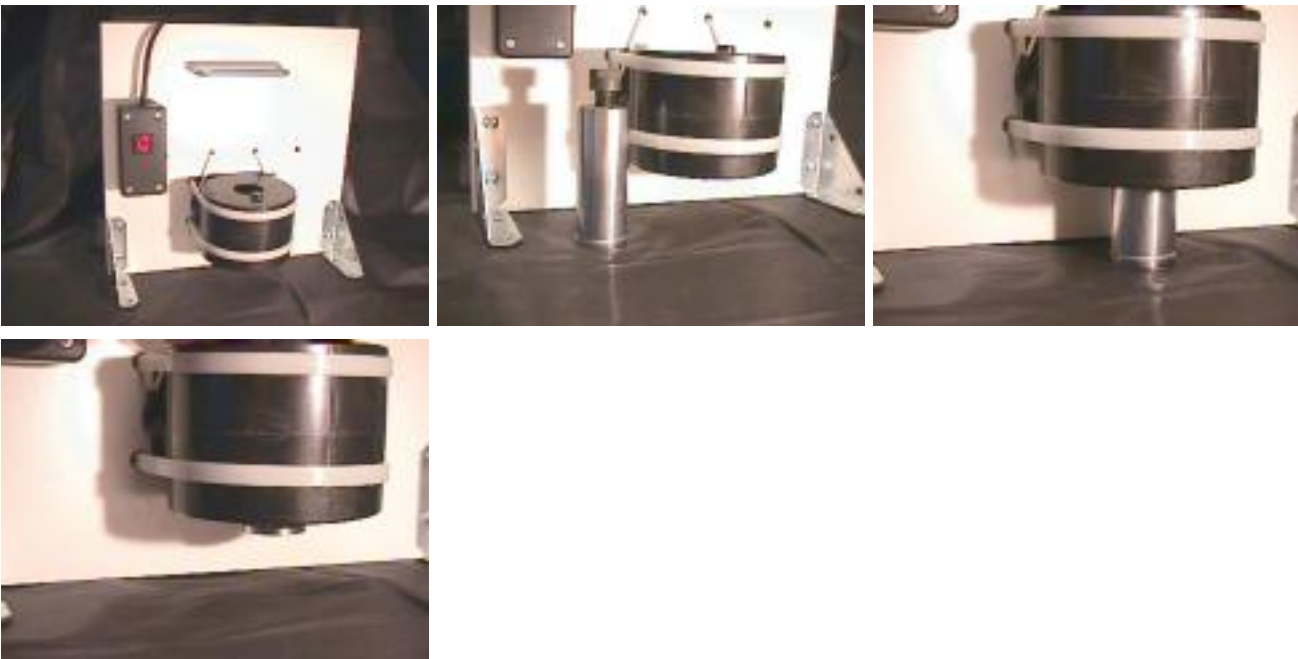

This shows the construction of a more powerful solenoid demonstrator. It uses a DC coil from a large contactor. The iron armature weighs about 2 pounds. When the power is turned on, the iron armature is pulled into the solenoid. If the solenoid were laid down onto its back, the iron armature can be pulled out part way from the solenoid and released, allowing it to be pulled back in just like it's attached to a spring. Great fun to play with!



Here's a commercial solenoid from an appliance. Some spring or other mechanical action would be attached to the ring on the left. When energized, the armature is pulled in as shown on the right. When de-energized, the spring (or gravity) would pull the armature back out. This can be used for door locks, for home door chimes, actuators, and thousands of other things.



This is a solenoid from a dishwasher. When energized with 120Vac, it will open a valve allowing the water to fill the dishwasher. De-energizing it causes the valve to close, shutting off the water.

Conclusions:

A solenoid will hold an iron armature within its air core as long as there is power applied to it. When held vertically, the armature will be suspended in the air (but will be pulled to one side of the inside of the core). When de-energized, the armature will fall or be pulled back to its rest position.

Doorbells EXPT

Have you ever taken a close look at your doorbell? The one that goes "Bing-bong" for the front door button and just "Bing" for the back door button? How does it work? Why is the back door sound different? (It was

made different so you would know if the back doorbell was being pushed instead of the front doorbell. But, how do they do that?)

I found an unused doorbell over at my in-law's basement and mounted it onto a board, along with two push buttons and a 19Vac plug-in power supply. This has been a great demonstrator for kids.



First, you will notice that there are two solenoids in this thing. One that is energized when the button at the front door is pushed (the one on the left in the photos), and one that is energized when the button at the back door is pushed. When a button is pushed, the solenoid is energized, pulling the iron armature into the coil, causing the end of the armature to hit the higher sounding (shorter) gong at the bottom. It then stays in the solenoid while the button is held closed. When the button is released, the spring on the armature pulls it out of the solenoid causing it to hit the lower sounding (longer) gong at the top. That is why there is a "Bing" when the button is pushed, and a "bong" when the button is released.

For the back door, it is almost identical. When the back door button is pushed, the iron armature on the right is pulled into its energized solenoid, causing it to hit the higher sounding gong at the bottom. Notice one thing, though. The spring on the back door armature has fewer turns, making it weaker than the spring for the front door. This was done on purpose. Also, there is a side marked "TOP" for this doorbell, with the lower sounding gong at the top, not at the bottom. So, when the back door button is released, the weaker spring on the armature pulls it out of the solenoid with little force, so it would not hit the lower sounding gong at the top with much force. Not only that, but the top end of the armature for the back door has a piece of cork on it instead of hard plastic, so that when it did hit the lower sounding gong, it would be muffled. This is why it goes "Bing" when the button is

pushed, and "(quiet)" when the button is released. Pretty neat, huh?

Next time, try your doorbell to see if it also works this way. After a few minutes, your mom might ask you to stop, but let her know that you are doing engineering work figuring out how solenoids work. Then do what she asks you to do (like stop ringing the doorbell)!



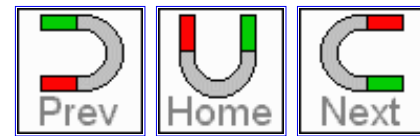

Experiments with magnets and our surroundings

Magnets and biology

This is a fascinating field of study, and still very new with a lot more to learn. I am not an expert in this area, so I will refer you to some links and articles where you can start a search of your own.

Do magnetic fields affect biological organisms?

Here are some references that can start you out. Science fair demonstrations in this field is not easy, and requires several months to grow and observe plants or animals.

Science News Online, Jan 10, 1998, **EMF's Biological Influences**, Janet Raloff

<http://www.spor4u.com/post/doc.html> Bioelectromagnetics Applications in Medicine

<http://grants.nih.gov/grants/guide/rfa-files/RFA-ES-94-001.html> Cellular Effects of Low Frequency Electromagnetic Fields

Biomagnetic therapy

Many people claim that wearing innersoles in their shoes containing a magnet, or bracelets made of copper with small magnets on the ends, or other magnetic therapy helps to relieve them of some pains or reduce depression. I don't know. Perhaps some of this is real, perhaps most of this is imaginary. Some therapists define North magnetic poles opposite to what is accepted by the engineers who fabricate the magnets. This makes you wonder if the promoters of these therapeutic magnetic devices know what they are talking about. However, for you to start checking into this yourself, here are a few links to start you out:

<http://www.magnetman.com>

<http://skepdic.com/magnetic.html>

<http://www.quackwatch.org/04ConsumerEducation/QA/magnet.html>

<http://www.holcombhealthcare.com/reports/pub-bio.html>

<http://www.cbsnews.com/stories/2003/09/16/earlyshow/contributors/emilysenay/main573628.shtml>

<http://www.hinduonnet.com/thehindu/mp/2002/11/11/stories/2002111101030300.htm>

<http://www.painrelief.org.uk/>

<http://www.painreliefmagnets.com/catalog.html>

<http://www.pubmedcentral.nih.gov/articlerender.fcgi?artid=155398>

<http://www.sciam.com/article.cfm?articleID=00041472-13DF-1D9A-815A809EC5880000>

<http://www.csicop.org/si/9807/magnet2.html>

http://www.findarticles.com/cf_0/m0HKL/5_7/66918308/p1/article.jhtml?term=Atheletes+attracted+to+magnets

<http://www.garynull.com/Documents/magnets.htm>

I have also heard of some who have made the statement that you should only cook with non-magnetic pots and pans. This usually means stainless steel. However, there are some stainless steels that are slightly magnetic. It depends on the amount of impurities making the alloy, and the processing of the steel. Cold rolled versus hot rolled have an affect on this property. All of these change the crystalline structure, that in turn can change the magnetic properties. I have not seen any

study that can show how the magnetic property of a pot or pan can affect the leeching of impurities into the food you prepare in those pots. Sounds like a gimmick to sell something expensive.

Navigating with magnets

According to Tim Taylor of Home Improvement, men have magnetic boogers in their noses, allowing them to sense which direction is north. That is why men don't need to ask for directions! Ha, ha!

Seriously, what do we know?

First, magnets have been used to determine which direction is north. However, because the geomagnetic north pole is always moving and is not located where the geographic north pole is located, navigators have needed to maintain a chart of deviations between true north and magnetic north, depending on where they are located on the surface of the earth.

<http://antwrp.gsfc.nasa.gov/apod/ap001203.html> (be sure to check out all the related links - very useful information!)

Also, since ships have been made with iron, that affects the compass located on the deck of the ship. Often you see two grapefruit-sized iron balls, located on either side of the ship's compass. They were used to null the effects of the iron in the ship, so the compass readings would be true.

What about biological compasses?

Here are some links you may wish to use as starting points in your research. I'd like to express my thanks to Professor John Buntin at UW-Milwaukee for these references.

1: Biosystems 1981;13(3):181-201

Biogenic magnetite as a basis for magnetic field detection in animals.

Kirschvink JL, Gould JL

Bacteria, sharks, honey bees, and homing pigeons as well as other organisms seem to detect the direction of the earth's magnetic field. Indirect but reproducible evidence suggests that the bees and birds can also respond to very minute changes in its intensity. The mechanisms behind this sensitivity are not known. Naturally magnetic, biologically precipitated magnetite (Fe₃O₄) has been found in chitons, magnetotactic bacteria, honey bees, homing pigeons, and dolphins. Its mineralization in localized areas may be associated with the ability of these animals to respond to the direction and intensity of the earth's magnetic field. The presence of large numbers (approximately 10⁸) of superparamagnetic magnetite crystals in honey bees and similar numbers of single-domain magnetite grains in pigeons suggests that there may be at least two basic types of ferrimagnetic magnetoreceptive organelles. Theoretical calculations show that ferrimagnetic organs using either type of grain when integrated by the nervous system are capable of accounting for even the most extreme magnetic field sensitivities reported. Indirect evidence suggests that organic magnetite may be a common biological component, and may account for the results of numerous high

field and electromagnetic experiments on animals.

PMID: 7213948, UI: 81161405

2: J Exp Biol 1988 Jan;134:27-41

Homing of magnetized and demagnetized pigeons.

Walcott C, Gould JL, Lednor AJ

Laboratory of Ornithology, Cornell University, Ithaca, NY 14850.

Homing pigeons appear to use the earth's magnetic field as a compass and perhaps as part of their position-finding system or 'map'. The sensory system they use to detect magnetic fields is unknown, but two current possibilities are some mode of response by the pineal organ or by the visual system, or it may be based on the magnetite crystals found in their heads. Three series of experiments to test the involvement of magnetite are reported here. The alignment of the permanent magnetic domains in the birds heads was altered by (a) demagnetizing the birds, (b) magnetizing them with a strong magnetic field and (c) exposing the birds to a strong magnetic gradient. None of these treatments had a marked effect on the pigeon's orientation or homing under sunny skies, but a few results obtained under overcast skies suggest that demagnetizing the birds may have increased the scatter of their vanishing bearings. Perhaps pigeons use one magnetic sensor for their magnetic compass and another for some component of the map.

PMID: 3356963, UI: 88187587

P.S. Here's another cool thing you can do with magnets: if you have an aquarium full of shrimp with a sandy substrate, the shrimp will incorporate sand grains into their statocysts, which are sensory organs of balance and equilibrium very similar to our semicircular canals. The sand grains move around in a fluid filled sac as the animal moves, tilts, etc., and in the process, the grains bend sensory hairs which provide information about the animal's position in space. There is a famous anecdotal story about an Austrian scientist by the name of Kreidl who, in the late 1800s, dramatically demonstrated how the statocyst worked by removing all the sand in the bottom of an aquarium filled with shrimp. Shortly before the animals molted (which is the time that normal animals acquire new sand grains for their statocysts) he replaced the sand with iron filings. The shrimp incorporated the filings into their statocysts instead of sand, and Professor Kreidl then had hours of fun making the shrimp assume all sorts of bizarre postures and orientations by making the filings move in various ways by dragging a magnet around on the bottom of the aquarium.

I've never tried it but it sounds interesting and fun!

See also:

http://www.nature.com/cgi-taf/DynaPage.taf?file=/nature/journal/v400/n6742/abs/400324a0_fs.html

Nature 400, 324 - 325 (1999) © Macmillan Publishers Ltd. (Nature magazine, July 22, 1999, p324)

Extraocular magnetic compass in newts

M. E. DEUTSCHLANDER, S. C. BORLAND & J. B. PHILLIPS

Geomagnetic orientation is widespread among organisms, but the mechanism(s) of magnetoreception has not been identified convincingly in any animal. In agreement with biophysical models proposing that the geomagnetic field interacts with photo-receptors, changes in the wavelength of light have been shown to influence magnetic compass orientation in an amphibian, an insect and several species of birds (reviewed in ref. 5). We find that light-dependent magnetic orientation in the eastern red-spotted newt, *Notophthalmus viridescens*, is mediated by extraocular photoreceptors, probably located in the pineal complex or deeper in the brain (perhaps the hypothalamus).

Nature 390, 371 - 376 (1997) © Macmillan Publishers Ltd.

Structure and function of the vertebrate magnetic sense

MICHAEL M. WALKER, CAROL E. DIEBEL, CORDULA V. HAUGH, PATRICIA M. PANKHURST,
JOHN C. MONTGOMERY & COLIN R. GREEN

Some vertebrates can navigate over long distances using the Earth's magnetic field, but the sensory system that they use to do so has remained a mystery. Here we describe the key components of a magnetic sense underpinning this navigational ability in a single species, the rainbow trout (*Oncorhynchus mykiss*). We report behavioural and electrophysiological responses to magnetic fields and identify an area in the nose of the trout where candidate magnetoreceptor cells are located. We have tracked the sensory pathway from these newly identified candidate magnetoreceptor cells to the brain and associated the system with a learned response to magnetic fields.

Experiments EXPT

What kinds of experiments can we do to learn more?

1. Try growing peas with a strong magnet located under the roots. Try a south pole and a north pole.
2. Try growing peas within a Helmholtz coil assembly with a constant (dc) magnetic field.
3. Try growing peas within a Helmholtz coil assembly with an ac magnetic field
(Remember to have a control for the experiment where there is not a magnetic field at all, except for the earth's natural one.)
4. Do you have other ideas?





Experiments with magnetic levitation

Diamagnetic Levitation EXPT

This is an experiment where a magnet will float between two diamagnetic plates. No electromagnets are needed, no sensors are needed, no current source is needed. Only one other magnet is needed to help balance the force of gravity.



The fixture seen here was purchased from www.magnetlevitation.com and is a very well assembled and thought out demonstrator of diamagnetic levitation. As you remember, [diamagnetism](#) is a property of some materials where they repel magnetic fields, both North and South poles. Is it possible to make a magnet float on top of a diamagnetic piece of material? Is it possible to make a piece of diamagnetic material float on top of a magnet? The answer is YES to both of these questions.

With this fixture, we have a magnet that will float between two pieces of [pyrolytic graphite](#), a fairly good diamagnetic material. If it is too close to the graphite on the bottom, it will rise. If it is too close to the graphite on the top, it will drop. Eventually, it will find a happy mid-point where it will hover, or levitate, stably. Since the magnet is a bit heavy, though, a lifter

magnet is needed to counteract the force of gravity on the floater magnet. This lifter magnet is seen here at the top of the photo. It is a 1/2" diameter by 1/2" long cylindrical NIB magnet, stuck to the head of a flat-head screw. The screw is used to adjust the distance between the lifter magnet and the floater magnet.

I started the set-up by attaching the lifter magnet to the end of the flat-head screw. Then I moved the adjustable arm, holding the top graphite disk, so that the distance between the graphite disks is about 7mm.

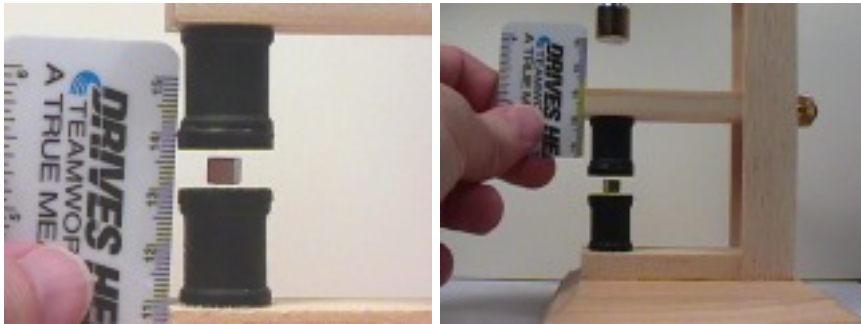

Next, I adjusted the screw of the lifter magnet to be about 20mm above the top surface of the adjustable arm. Then I placed the small cube magnet between the graphite disks to see what would happen.

If the lifter magnet was too close to the floater magnet, the floater magnet would be touching the top disk.



If the lifter magnet was too far away from the floater magnet, the floater magnet would be touching the bottom disk.

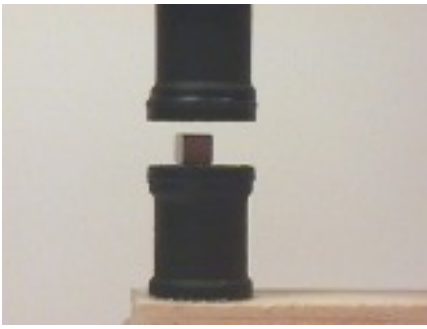

By carefully adjusting the lifter magnet, I was easily able to get the floater magnet to hover between the two disks as shown here.



I even tried tipping the fixture at an angle to see what would happen. The floater magnet would get close to the edge of the disk and start to drop down since it didn't have the diamagnetic support beneath it.



The two black objects are small spools to which the graphite disks are glued.

Hats off to Seth Troutner for making such an elegant fixture for demonstrating diamagnetic levitation!

He notes a couple of things you should be aware of:

- a) temperature variations will cause the floater magnet change its position up or down
- b) nearby magnets, steel screws and hinges or a steel table surface will have an affect on the floater magnet

The thing to do is to set this up in the middle of a wooden table.

After you have it working, then you can start having even more fun trying things like:

- 1) how will a magnet in your hand about 8" from the floater magnet affect it? (rotate it in your hand)
- 2) what if you place another magnet below the table?
- 3) try placing the fixture onto a steel desk
- 4) what happens when the room temperature increases?
- 5) what happens when the room temperature decreases?
- 6) try a different shape for the floater magnet, like a disk or a ring magnet
- 7) try slipping various pieces of material underneath the lifter magnet like aluminum, copper, brass, lead, paper, an American quarter, a Canadian quarter, wood, your fingers, a shallow glass dish of water, a shallow glass dish of ice, plastic, a CD, etc. What happens to the floater magnet?
- 8) try building your own levitator
- 9) try using your fingers for the top and bottom diamagnetic material
- 10) try building a seismometer using a diamagnetic levitator (or using two of them)

Here are some other links to diamagnetic levitation experiments:

www.magnetlevitation.com

www.fieldlines.com/other/diamag1.html

www.physics.ucla.edu/marty/diamag/

www.sensorsmag.com/articles/0301/30/main.shtml

davidfiedler.com/levitation.htm

www.erg.sri.com/automation/diamagnetic.html

www.otherpower.com/newmaglev.html

www.hep.princeton.edu/~mcdonald/examples/diamagnetic.pdf

www.matchrockets.com/ether/diacglev.html

www.geocities.com/Area51/Shire/3075/maglev.html

kuestler.bei.t-online.de/whatis.htm

www.hfml.sci.kun.nl/levitate.html

www.scitoys.com/scitoys/scitoys/magnets/suspension.html

www.scitoys.com/scitoys/scitoys/magnets/pyrolytic_graphite.html

4ua.com/scitoys/cgi-bin/shop.exe?page=magnet_desc.html

www.jclahr.com/science/physics/diamag/phillips.html

www.rnw.nl/science/html/magnets990813.html

www.phys.ens.fr/~schreck/MagicMagnets/

www.graphitemachininginc.com/page7.htm

www.spmtips.com/products/hopg/

www.geocities.com/meredithlamb/page061.html

www.geocities.com/meredithlamb/page060.html

www.geocities.com/meredithlamb/index.html

www.graphite-eng.com/





Experiments with magnets interacting with other magnets

More cool magnetic toys you can buy

Please note: the information at the end of each article refers to the part number of that item at the source indicated. Arbor is [Arbor Scientific](#), Edmund is [Edmund Scientific](#), AS&S is [American Science and Surplus](#), EdIn is [Educational Innovations](#).

Magnetron:

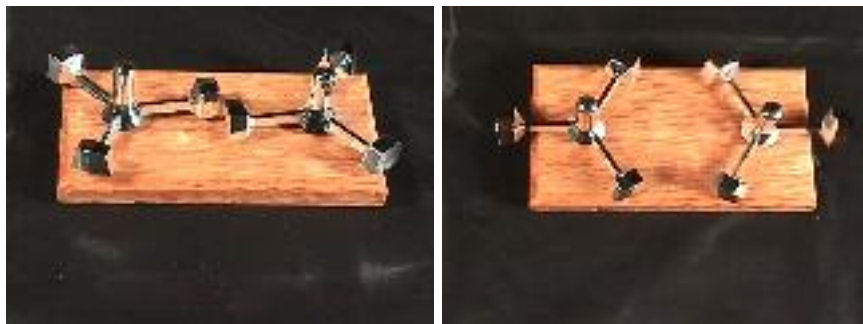

Each rotor has three arms, each containing a magnet with its North pole facing out. As you give one rotor a gentle spin, the other one will eventually begin to interact with it and the angular momentum will begin to bounce back and forth between the two rotors, one stopping and the other abruptly starting, then reversing. It is great fun in the office. See [Patent #5135425](#).

This costs about \$12.

Arbor P8-1160, Edmund 81-452, AS&S , EdIn

Revolution:



This demonstrates a magnetic bearing, since the spinner floats on magnetic fields. There is a Plexiglas wall at one end on which a steel point pushes against and minimizes the friction seen by the spinner. There is some windage (friction between the spinner and the air as it rotates) but it will continue to spin for 3 or 4 minutes after you give it a good spin. It isn't balanced real well so sometimes it wobbles as it slows down, but not too bad. It also is great for your desk in the office. See [Patent #5182533](#). This costs about \$15.

Arbor P8-6000, Edmund 53-435, AS&S 89340, EdIn

Levitron:



This is a great toy which is a real attention getter. The spinning magnetic top will float above its base for about 3 minutes before it slows down too much and stops. There are some great web sites which discuss the physics of this exhibit. It does take some practice to get the top to spin smoothly, and it takes several tries to determine the proper amount of weight to place

on the top so that it will just barely stay afloat. If the top is too light, it will not stay on top of the magnetic field of the base. If the top is too heavy, it will not float at all.

The way to make it work is to start the top spinning in the middle of the plastic plate while it is sitting on the base. Then you gently lift the plastic plate, with the top still spinning on it, about 1" upward, so that the top now finds a place in the air above the base where it will remain. If things are not right, the top will fall to one side or another, like a ball rolling off of another ball. To fix this, the base has to be tipped very slightly up on the side where the top falls off. Another thing to keep in mind is that as it warms up (due to room temperature changes or playing with it), some of the weights need to be removed for it to still be able to float.

Also check out these sites about how this toy works:

<http://www.physics.ucla.edu/marty/levitron/>

<http://koerner.chem.yale.edu/levitron.html>

<http://www.lauralee.com/levitron.htm>

[Patent #5404062](#)

[Patent #4382245](#)

<http://www.levitron.com/>

This costs about \$40 (but it's really cool!).

This is hard to find, now, since the Super Levitron is available.

Super Levitron



This is a super, stronger, higher flying version of the original Levitron above. I just purchased this, and am getting this to work. This costs about \$50.

Arbor P8-3000, Edmund 81-525, AS&S 89942, EdIn M-3

Levitron Perpetuator:



This is for the person who does not want to see his Levitron stop spinning and floating in mid-air. It has an electromagnet in the base which keeps the top spinning indefinitely. It took a while to make mine work with my Super Levitron, and it will stay put for a max of about 15 minutes before something happens to make it fall off to the side. It's a bit tricky to set up. Costs about \$60.

Arbor P8-3100, Edmund 81-527, AS&S , EdIn M-4

MagnaSwing:



This has 5 pendulums, very similar to a toy which uses five steel balls. The difference is that each pendulum has a magnet in it, oriented so that they repel each other. Start one swinging, and watch the others bounce around. The motion continues for a long time since there is no energy lost in the collisions, and little energy lost in windage and friction on the wire supports. This is a real nice toy! See [Patent #5026314](#). (Fascination Toys & Gifts, Inc., Seattle, WA) This costs about \$14.

Arbor , Edmund 81-551, AS&S 91213, EdIn

Decision Maker, ROMP:



A novel way to make decisions or selections which are somewhat random. There's a magnet in the pendulum, and you place the other colored magnets on the base, without knowing what their polarity is. Swing the pendulum and see which colored magnet on the base it ends up pointing to. Similar to the [Herky-Jerky](#). The one on the right is called the Randomly Oscillating Magnetic Pendulum (ROMP) from [Hog Wild, Inc.](#) This cost about \$8.

Arbor , Edmund 82-172, AS&S 91379, EdIn

Magnetic Earrings:



A new way to attach earrings to your ears; using magnets! There is a small pair of NIB magnets for each earring, one attached to the back of the decorative flower, and the other loose. They are strong enough to attract each other when they are about 1/2" away from one another. The 3/16" thickness of an earlobe is no problem for this. (And you don't have to have your ears pierced, either.) They cost about \$5 at an earring shop in the mall.

Arbor , Edmund , AS&S , EdIn

Magnaprobe and Magnetic Earth:



The Magnaprobe holds a small alnico magnet in a jewelled gimbal so that it can orient itself in any direction as needed. The ball which looks like earth has a strong magnet inside of it. Bringing the probe close to the earth causes the probe to swing around to point to the magnetic north or south pole as you move it over the surface of the earth. Great way to teach how the magnetic field on the earth works. Purchased from [Arbor Scientific](#). The probe costs about \$12, the earth costs about \$5.

Arbor P8-8005, P8-1130, Edmund 42-217, AS&S , EdIn

Seal and Ball



This is a cute toy where the seal can cause the ball to spin, or it can balance the ball on its nose. Purchased from Arbor Scientific. Costs about \$6.

Arbor , Edmund , AS&S , EdIn

Moo Magnet



A very well put together kit with a set of ring magnets, washers, end-caps and a threaded rod. Great ideas in the booklet which is a part of this! Super!
Costs about \$7.50.

Arbor , Edmund , AS&S , EdIn M-450

Perpetual Calendar



This is a piece of art. It is a calendar that uses magnets to set the month and the date. Very sharp! Costs about \$35.

[Museum of Modern Art](#)

Diamagnetic Levitator



This is a great item that demonstrates the diamagnetic property of certain materials. A small magnet floats between two graphite disks. No batteries, no wires, just magnets. Very cool! Costs less than \$20.

www.magnetlevitation.com





Where to obtain the supplies and equipment

Catalog houses and stores

Please note: the information at the end of several articles refers to the part number of that item at the source indicated. Arbor is [Arbor Scientific](#), Edmund is [Edmund Scientific](#), AS&S is [American Science and Surplus](#), EdIn is [Educational Innovations](#).

Wondered where to purchase the magnets, motors, and other things you need to make the demonstrations discussed on these web pages? Try these places:

Magnets, experimental kits, etc:

[Edmund Scientific](#)

[Arbor Scientific](#) Arbor has very handy instruction sheets and ideas which they ship with their kits

[Teachersource](#) Educational Innovations

[Dowling Magnets](#) for a [train maglev kit](#) and strip magnets

[AUSSIE magnets](#) (the Magnet Shop) for those in Australia who need a great source for magnets!

[The Magnet Source](#)

[ForceField](#)

[Amazing Magnets](#) for NIB magnets, steel balls, magnetic sculptures, great site!

[K&J Magnetics](#)

[Radio Shack](#) for electronic parts, kits, a few magnets

[Digi-Key](#) for electronic components, Hall-effect sensors, etc.

[Marlin P. Jones & Assoc.](#)

[Pasco](#)

www.amazing1.com/voltage.htm for some great high voltage kits

NIB magnets, motors, aluminum tubes, plug-in power supplies, other odds and ends:

[American Science and Surplus](#)

[Neon sign company, has high voltage neon transformers!](#)

Hardware, screws, tee-nuts, stainless steel screws and bolts, shelving boards, metal plates (aluminum, brass, copper):

Menards Hardware or Handy Andy or Home Depot

[Ace Hardware](#)

[True Value Hardware](#)

Copper bars and plates:

[Central Steel & Wire Co.](#)

Cool Toys:

[Arabesk](#) (Netherlands) super sculptures and toys with magnets!

[The Nature Company](#)

[The World of Science](#)

[The Museum of Science and Industry](#)

[Discovery World](#)

[Science Stuff](#)

[Shop for Science](#)

[Science Museum links](#)

www.e20.physik.tu-muenchen.de/~cucke/toylinke.htm

www.toymagnets.com

Software for simulating magnetic and electromagnetic fields:

[Ansoft Corporation](#) they just released a **FREE Student Version** of their 2D Maxwell program!!! Get a copy now!!

[Simplorer](#) software for simulating electrical circuits, **FREE Student Version** available!!

[Free finite element program for solving and seeing magnetic fields!](#)

[Formulas used for solving magnetic problems](#)

[Vector Fields software](#)





Executive toys without magnets

Cool executive toys you can buy (or make)

Please note: the information at the end of each article refers to the part number of that item at the source indicated. Arbor is [Arbor Scientific](#), Edmund is [Edmund Scientific](#), AS&S is [American Science and Surplus](#), EdIn is [Educational Innovations](#).

Euler's Disk



This consists of a fairly heavy disk and a concave mirrored surface. Giving the disk a spin, like a coin, causes it to wobble and rotate for a long time. Very clever! (from Tangent Toy Co., Sausalito, CA) Check out www.eulersdisk.com. Cost is about \$30.

Arbor , Edmund 81-183, AS&S , EdIn

Illusion Kaleidoscope



This is a new type of kaleidoscope where you don't have to move the objects

you are looking at. It uses a space tube (sealed glass tube with glitter and color in water). Hold the tube vertically and look through the kaleidoscope while the particles slowly fall past the end of the mirrors. A nice toy to have around. (from Wildewood, 1-800-458-8255) Cost is about \$20.

Arbor , Edmund , AS&S , EdIn

Gyro-Ring



Once you start the small rings spinning, you can keep them going by rotating the large metal ring. Something unusual! Takes a bit to master. (from Fascinations, Seattle, WA) Cost is about \$10.

Arbor P3-3600, Edmund , AS&S , EdIn SS-18

Mini Rubik's Cube



A smaller version of the popular 3x3x3 Rubik's cube. Not quite as difficult to sort out, but still a challenge. (from OddzOn, Campbell, CA) Check these sites out for the solution, realize you only have corner cubes, no edge cubes or face cubes.

<http://www.rubiks.com/>

<http://www.stanford.edu/~offsky/cube/index.html>

<http://www.math.brown.edu/~reid/rubik/index.html>

Cost is about \$6.

Arbor , Edmund , AS&S , EdIn

Magic Sand Wand



How can you get the steel ball to go from one end to the other? See [Patent # 4506892](#). Cost is about \$6.

Arbor , Edmund 81-555, AS&S 91214, EdIn SS-19

Slipper or Water Wiggler or Water Weenie



I'm not sure of the name, but it sure is slippery, wierd and fun! Cost is about \$3.

Arbor , Edmund , AS&S 91383, EdIn

Soma Cube



Similar to [pentominoes](#), but not quite as versatile. You can make your own, or find them in a store.

Arbor , Edmund , AS&S , EdIn

Tri-Zonal Space Warper



Very cool! See immovable things move! (from [Binary Arts](#)) Cost is about \$5.

Arbor , Edmund , AS&S , EdIn

Twin Tangle



There are a lot of different twisted metal puzzles out there, but this is a fairly nice one to actually own. (from [Binary Arts](#)) Cost is about \$8.

Arbor , Edmund , AS&S , EdIn

Wire Puzzle



This is a clever puzzle made of bent wire pieces held together by copper springs. Several different types of shapes are possible! (I received this as a

gift, so I don't know how much it cost or where it came from).

Arbor , Edmund , AS&S 91402, EdIn

Klxxx



Fun to play with when there's nothing else to do. (from [Chase Toys](#),
Ventura, CA) See [Patent # 5172537](#).

Arbor , Edmund , AS&S , EdIn

Drinking Bird



Once you start the bird drinking, it will keep on going as long as the water level is kept above a minimum height. This has been around for many years, but it still works great and is fun to watch. (from [Arbor Scientific](#), Ann Arbor, MI) Cost is about \$5.

Arbor P3-5001, Edmund 53-617, AS&S 3808, EdIn DB-100

Rattleback, also known as Celt



Very unusual device. Start it spinning in one direction, it will slow down, wobble back and forth for a moment, then start spinning in the opposite direction all by itself! I first saw this on the Johnny Carson show about 20 years ago. (Can be obtained from TEDCO, Hagerstown, IN, 1-800-654-6357 or at <http://www.sciencestuff.com/toys2.htm>). Costs about \$3.50. Also available from [Arbor Scientific](#) at 2 for \$3.95.

Arbor P2-2120, Edmund 39-089, AS&S 88910, EdIn SS-300

more info: <http://fourier.dur.ac.uk:8000/~dma0rcj/torque.html>
http://www.ps.ic.ac.uk/~astolfi/Section/Events/Seminars/abs_m_hub.html

For a rattleback about 12 inches long, contact Charles W. Sherburne, 3409 Patton Avenue, San Pedro, CA 90731. He calls it an ARK, and it is an art object beautifully molded in black plastic. Price is about \$20. His literature indicates that he has a design patent on the ARK #D.E.S. 210,947.

Jacob's Ladder



This was a lot easier to make than I thought! I purchased a used neon sign transformer from a neon sign company. It is rated at 15,000V out at 30mA. I cut a coat hanger into two pieces and formed them as shown. The gap at the bottom is about 1/4", the gap at the top is about 3". Plug it in, and watch the arc climb! **Be very careful. This will give you a very bad shock if you touch it while it's on, and a bad burn!**

<http://www.misty.com/people/don/jacobs.htm>

<http://fig.cox.miami.edu/~burgess/tesla.html>

Cost is about \$25.

Arbor , Edmund , AS&S , EdIn

Moving Spool



Great fun to fool your friends! Check out the [reference](#). You can make this roll either toward you or away from you as you pull the string. The spool is a roller for boat trailers. It cost about \$3. That's all there is to it. I added a bolt for some additional weight.

Arbor , Edmund , AS&S , EdIn

Pendulum Man



A new way to investigate simple periodic motion as well as chaotic motion. The various arms and legs attach to a central rotating connector which can be stuck to a refrigerator door (yes, it is magnetic). It cost about \$10 and is from www.hogwildtoys.com. See [Patent # 5145378](#).

Arbor , Edmund (they have this, don't know the number), AS&S , EdIn

Tops



I always enjoy checking out new styles of spinning tops. Here are two which are a little unusual. The one on the left actually spins on a glass marble embedded in the bottom of the wooden disk. This provides a hard, smooth, low friction surface for long spins. The top in the middle is also known as a "tippe top" since it will tip over or invert itself and spin on its stem after it is started. The real surprise with this top is that it will spin in the opposite direction than you may think after it inverts itself! For more info, check out the book "Physics Demonstration Experiments" by Harry F. Meiners, published by the Ronald Press Company, NY, 1970, vol 2, pp297-299 (there is even a photo of Professors Pauli and Bohr watching a tippe top spin). The one on the right is simply a nice top from the Greenfield Village.

<http://bart.aero.psu.edu/courses/emch520/html/node4.html>

Arbor , Edmund , AS&S 88697, EdIn SS-8A

"Hour Glass"



There are a lot of different kinds of hour glasses around, including those that provide some spinning motion as a liquid drips from one location to another.

However, this is more like a conventional pair of hour glasses, but where the black sand falls, and the yellow sand rises in their respective liquids.

Cost was about \$10.

Arbor , Edmund , AS&S 91377, EdIn

Fly Shooter



This is more than a toy, it is a real fly swatter. By pressing the white "dart" with the round flyswatting grid onto the gun, a spring is compressed. You aim the swatter and when the trigger is pulled, it is launched and squashes the pesty insect. The string prevents the swatter from getting lost or zooming across the office and landing in someone else's cubicle, by accident. Be the envy of your peers!

<http://www.martinpaul.com/flyshooter.html>

Cost was about \$5.

Arbor , Edmund , AS&S , EdIn

SwissCard



Now this is a clever tool! You have, in a card which measures only 3.25" x 2.125" x 0.1875", a knife, scissors, nail file, screwdriver, toothpick, tweezers, ball-point pen, straight pin, mm scale and inch scale! Cool! This one was a gift from Rockwell Automation (hence the logo) but they are available in stores that sells Victorinox Swiss Army knives.

<http://www.lazarsluggage.com/lazarsluggage/5120.html>

Cost is about \$27.

Arbor , Edmund , AS&S , EdIn

Flashing Ball



This is a real eye catcher! Bounce the ball, and it will start to flash a couple of LEDs inside. After a few seconds, it'll stop. After the batteries die, there's no way to replace them. Still, it's fun. I received this as a prize, but here are a couple of web sites which may help you find your own:

<http://dogtoys.com/willie/fetchglowjr.html>

<http://shop.petmarket.com/petmarket/lasflasbal.html>

Arbor , Edmund , AS&S 91304, EdIn

Tangle Puzzle



An interesting little item to twist and turn.

Arbor , Edmund , AS&S , EdIn

Roller Ball



This is a lot cooler than I thought. You start the yellow ball spinning with a small string, then you hold the green case and rotate your wrist back and forth, causing the yellow ball to speed up. After a couple of minutes, your wrist actually will start feeling tired due to the workout it's getting. I got this at American Science & Surplus for only \$8, but also found it in a store in a mall for \$23!

Arbor , Edmund 82-416, AS&S 91247, EdIn

Radiometer



I'm sure you know how this works: heat creates a lot of molecular activity in front of the dark colored vanes, causing it to spin. I picked this up from Arbor Scientific. Cost about \$8.50.

Arbor P3-8105, Edmund 60-082, AS&S 26569, EdIn RAD-100

Hydro Gyro



Another unusual type of top or gyroscope. It is filled with water which flings to the outside of the spinning section, creating a vertical wall of water near the center! Cost about \$9.

Arbor , Edmund 82-362, AS&S 91652, EdIn

Marble Twister

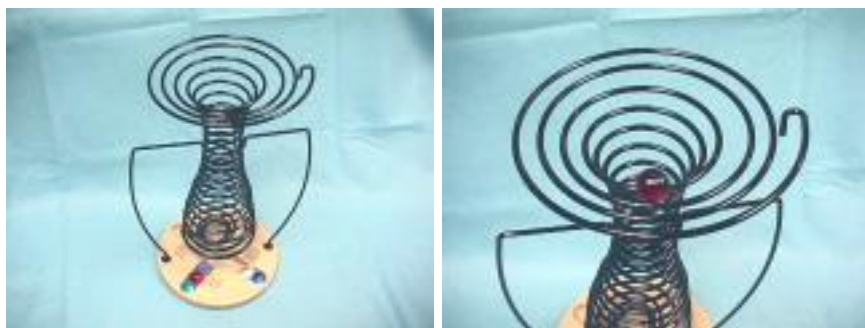

This is a fairly new item on the market. It is well built and works great!
Interesting idea with the centripetal forces. Cost about \$40.

Arbor , Edmund 82-423, AS&S, EdIn MAR-100

Atomic Clock



I'm sure you've seen these around. I received this as a gift. It's great to have a clock that's always right on! Every night, around 2am, it updates itself to the [WWVB](#) time signal from Fort Collins, Colorado. I don't even have to change it for [Daylight Savings Time](#)!

One of the best sites I've found for unusual toys and puzzles is here at:

www.arabesk.nl

Whenever you visit a science museum or a toy store, keep your eyes open for a new kind of toy!





Experiments with magnets and our surroundings

How strong are magnets?

Typical Values

Here is a list of how strong some magnetic fields can be:

Smallest value in a magnetically shielded room	10^{-14} Tesla	10^{-10} Gauss
Interstellar space	10^{-10} Tesla	10^{-6} Gauss
Earth's magnetic field	0.00005 Tesla	0.5 Gauss
Small bar magnet	0.01 Tesla	100 Gauss
Within a sunspot	0.15 Tesla	1500 Gauss
Small NIB magnet	0.2 Tesla	2000 Gauss
Big electromagnet	1.5 Tesla	15,000 Gauss
Strong lab magnet	10 Tesla	100,000 Gauss
Surface of neutron star	100,000,000 Tesla	10^{12} Gauss
Magstar	100,000,000,000 Tesla	10^{15} Gauss

What is a Tesla? It is a unit of magnetic flux density. It is also equivalent to these other units:

1 weber per square meter

10,000 Gauss (10 kilogauss)

10,000 magnetic field lines per square centimeter

65,000 magnetic field lines per square inch.

Now, 1Gauss is about 6.5 magnetic field lines per square inch.

If you place the tip of your index finger to the tip of your thumb, enclosing approximately 1 square inch, four magnetic field lines would pass through that hole due to the earth's magnetic field!

Measuring the strength of magnets

1. Hall-Effect Devices

A Hall-effect device is a piece of material which is affected by a magnetic field. By passing a constant amount of current through it in one direction, and by placing it in a magnetic field in another direction, we can measure a voltage across it in the third direction. This voltage is proportional to the strength of the magnetic field. This can be calibrated to provide a certain mV change for every Gauss of magnetic field. This effect was discovered by Edwin Hall in 1917. The materials often used today in these devices are indium arsenide or gallium arsenide. There are also superconducting devices which can measure minute magnetic fields, called SQUIDS.

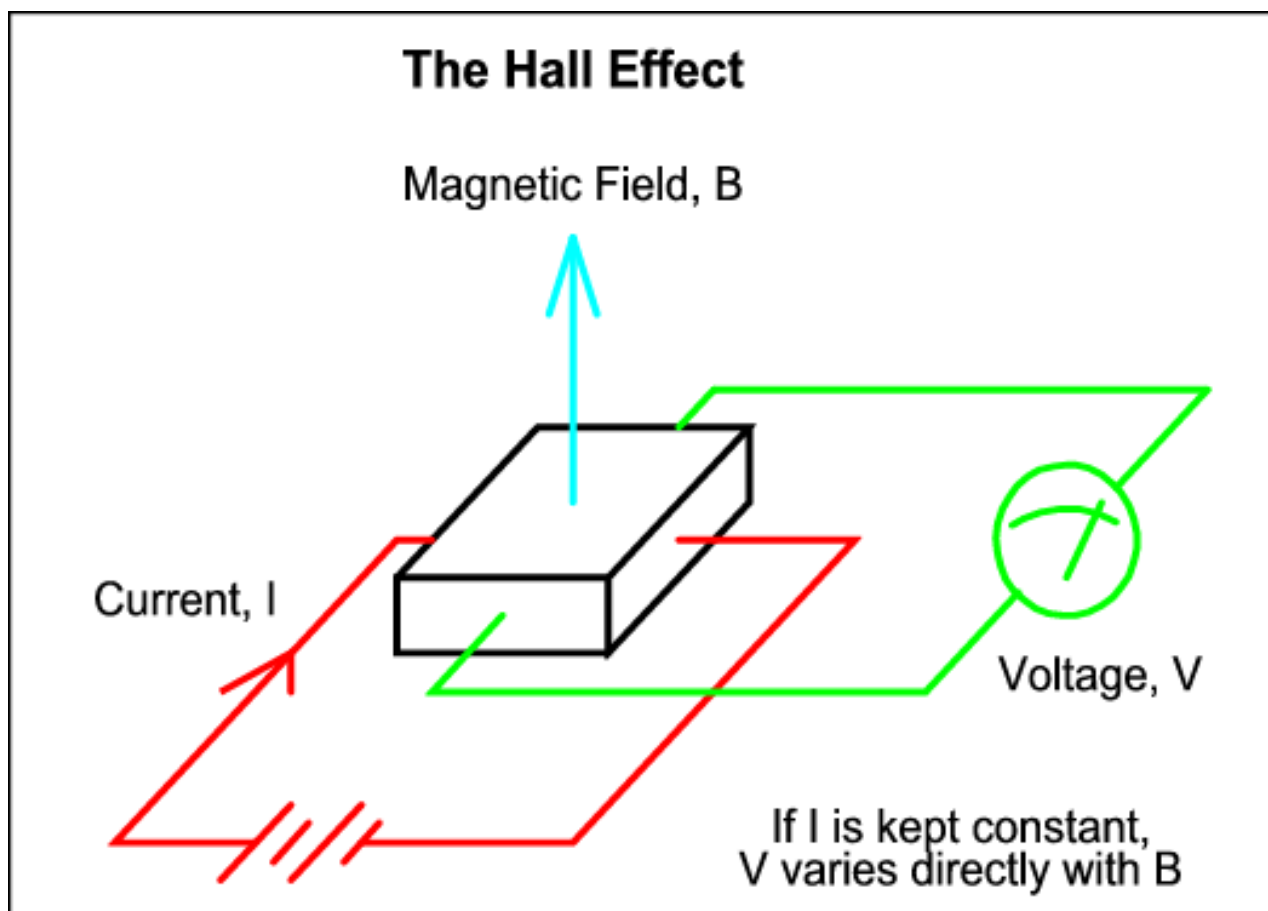

What can you do with a Hall-effect device? Build an electronic circuit which will amplify the voltage across the device and calibrate it so you can measure a voltage and translate that into a Gauss measurement. For such a unit, check out the page on building a [Gaussmeter](#).

2. Helmholtz Coils or Assembly EXPT

A Helmholtz assembly is actually a specific configuration of two coils. Each coil has the same radius. Also, the coils are placed parallel to each other. The distance

between the coils is the same as the radius of each coil. What makes this assembly special is that if each coil has the same current flowing through each other (by connecting them in series) and the direction of current is the same, the magnetic field within the center of the two coils changes very little as you move along the center line from one coil to the other. This is a way to create a volume with a fairly constant magnetic field throughout that volume of space.

More can be done with this. If a magnet is placed within the center of the Helmholtz assembly, pulsing the coils and reading the response will tell you the strength of the magnet.

There are some great articles describing how to build a supersensitive magnetometer using such an assembly, especially for tracking changes in the earth's magnetic field due to magnetic storms on the sun. Check out:

<http://www.eden.com/~rcbaker/magnetometer.htm> (dead link)

<http://www.scientificamerican.com/2000/0300issue/0300amsci.html> (dead link)

<http://www.netdenizen.com/emagnet/> for details on calculating the field within a Helmholtz coil assembly

3. Halbach Array

A Halbach array is an arrangement of permanent magnets in order to achieve a fairly uniform magnetic field within a volume of space, similar to the idea behind the Helmholtz coils assembly.

For more information, please refer to these sites:

Magnets, Markets, and Magic Cylinders, by Michael Coey and Denis Weaire

A Permanent-Magnet Based Vector Vibrating Sample

Magnetometer, by J.M.D. Coey, David Hurley, and Farid Bengrid

Design of an electrical machine with integrated flywheel, by Colotti Alberto, and Reichert Konrad

<http://www.iem.ee.ethz.ch/>

4. Paper clips and ball bearings

If you don't have a way to build a gaussmeter or magnetometer in order to measure the strength of the magnetic flux density of a magnet, then what else could you do? Try this.

1. Count how many paperclips or staples you can attach end to end from the north pole to the south pole.
2. Count how many paperclips or staples you can attach end to end hanging from one of the magnet's poles.
3. Have a big pile of paperclips or staples on the table and count how many will

stick to the magnet, all over the magnet.

4. Have a big pile of small (1 to 2mm in diameter, or 1/32 to 1/16" diameter) steel ball bearings or BBs in a plastic container, and count how many will stick to the magnet after you place the magnet into the middle of the pile and try to completely cover it with the ball bearings. Remove the magnet all covered with ball bearings, and take it to another plastic container to pull off and count the number of ball bearings that the magnet was able to attract to itself.

5. Magnetometer



This is a meter my brother had purchased in order to insure there was no residual magnetic field left on some equipment. It would show polarity and magnitude. It was made by Anno Instruments in Indianapolis. It is very sensitive. The area at the bottom of the meter is placed near the magnetic field to be measured.

What appears to be a good book on this subject is:

The Magnetic Measurements Handbook, by J.M. Janicke
Magnetic Research, Inc.

Answers to the rod problems:

Two rods

It is fairly easy to determine which rod is a magnet and which is not. I suspect that if you actually had those two rods in front of you, you would be able to figure it out. Here's a straightforward method to determine that.

Let's call one rod A and the other rod B. (Perhaps you could keep one in the left hand and the other in the right hand).

Next, touch the end of A to the middle of B.

If it sticks, then A is the magnet and B is iron.

If it does not stick, then B is the magnet and A is iron.

To double check this, touch the end of B to the middle of A.

If it sticks, then B is the magnet and A is iron.

If it does not stick, then A is the magnet and B is iron.

Why does this work?

In the center between the poles of a magnet, there is very little magnetic field or flux outside the magnet. All of the flux is inside the magnet itself. Because of this, iron is weakly attracted to the middle of the magnet if at all. However, the end or pole of a magnet will easily stick to any part of an iron rod.

Three rods

The solution to this is similar to the one above, but it just requires a little more work.

Let's call one rod A, one rod B, and the last rod C. Have them lined up on the floor in that sequence.

First, touch the end of A to the middle of B.

If it sticks, then A is the magnet, B is iron, and C is brass.

If it does not stick, continue.

Next, touch the end of A to the middle of C.

If it sticks, then A is the magnet, C is iron, and B is brass.

If it does not stick, continue.

Next, touch the end of B to the middle of A.

If it sticks, then B is the magnet, A is iron, and C is brass.

If it does not stick, continue.

Next, touch the end of B to the middle of C.

If it sticks, then B is the magnet, C is iron, and A is brass.

If it does not stick, continue.

Next, touch the end of C to the middle of A.

If it sticks, then C is the magnet, A is iron, and B is brass.

If it does not stick, continue.

Lastly, touch the end of C to the middle of B.

If it sticks, then C is the magnet, B is iron, and A is brass.

If it does not stick, something is wrong and you should try it all again.

Why does this work?

In the center between the poles of a magnet, there is very little magnetic field or flux outside the magnet. All of the flux is inside the magnet itself. Because of this, iron is weakly attracted to the middle of the magnet if at all. However, the end or pole of a magnet will easily stick to any part of an iron rod. Also, brass is not attracted to a magnet, so it will never stick to a magnet.



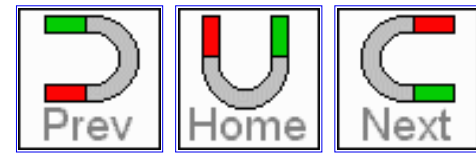

Magnet basics

How do magnets work?

Questions that often come up are, "How do magnets work?", or, "Why is iron magnetic?", or, "What makes a magnet?", or, "What is the magnetic field made of?"

Those are good questions, and deserve a good answer. However, did you know that there is a lot about magnets at the atomic level that isn't known yet? Just like with most of the other basic forces we are familiar with, such as gravity, electricity, mechanics and heat, scientists start by trying to understand how they work, what they do, are there any formulas that can be made to describe (and thus predict) their behavior so we can begin to control them, and so on.

The work always starts by simple observation (that's the fancy word for playing around with the stuff!). That's why it's so important to have some "hands-on" experience with magnets. Have you taken two magnets and tried to push like poles together? How far away do you start to feel the repulsion? How does the force vary with the distance between them? When the magnets are moved off-axis to each other (moving them to the side and not head on) what does it feel like? Could you describe it like trying to push two tennis balls together? When you flip one around, what changes? What about moving one around the other in a circle? Try these things! That's how you learn! Only when you play with (observe) them will you begin to understand how they work. This is the stuff great scientific pioneers did, like Faraday, Lenz, Gilbert, Henry and Fleming.

What we can find out this way, is some of the basics of magnetism, like:

- the north pole of the magnet points to the geomagnetic north pole (a south magnetic pole) located in Canada above the Arctic Circle.
- north poles repel north poles
- south poles repel south poles
- north poles attract south poles
- south poles attract north poles
- the force of attraction or repulsion varies inversely with the distance squared
- the strength of a magnet varies at different locations on the magnet
- magnets are strongest at their poles
- magnets strongly attract steel, iron, nickel, cobalt, gadolinium
- magnets slightly attract liquid oxygen and other materials
- magnets slightly repel water, carbon and boron
and so on

Now, the fun begins. We start to ask the question, "Why?" This is what scientists continually do - try to figure out why things behave the way they do. Once we figure that out, we have a better handle on how to apply them to make useful tools for us, right?

Let me share with you some of what is known about how magnets work. All of the questions have NOT been answered, perhaps you will help answer some of them. So, some of what is known are simply

observations, some are guesses, but a lot has been figured out.

Atomic Magnetism

There are only a few elements in the periodic table that are attracted to magnets. None of the elements, by themselves, make good permanent magnets, but can become temporary magnets (when close to another magnet). When alloys of various metals are made, some of these alloys make very good magnets. Why? We don't really know, but we can observe some consistent rules.

As you know, we have seen that when current flows in a wire, a magnetic field is created around the wire. Current is simply a bunch of moving electrons, and moving electrons make a magnetic field. This is how electromagnets are made to work. This will be important to keep in mind as we zoom into the structure of atoms.

Around the nucleus of the atom, where the protons and neutrons live, there are electrons whizzing around. We used to think that they had certain circular orbits like the planets have around the sun, but have discovered that it is much more complicated, and much more exciting! Instead, the patterns of where we would likely find the electron within one of these orbitals takes into account Schroedinger's wave equations. Pictures of each of these orbitals can be found at <http://www.shef.ac.uk/chemistry/orbitron/index.html>. (These also take into account Heisenberg's uncertainty principle and probability theory.)

First, electrons can be thought of as occupying certain shells that surround the nucleus of the atom. These shells have been given letter names like K,L,M,N,O,P,Q. They have also been given number names, such as 1,2,3,4,5,6,7. (This is what quantum mechanics is all about).

Within the shell, there may exist subshells or orbitals, with letter names such as s,p,d,f. Some of these orbitals look like spheres, some look like an hourglass, others look like beads on a bracelet.

The K shell contains an s orbital. Called a 1s orbital.

The L shell contains an s and p orbital. Called a 2s and 2p orbital.

The M shell contains an s, p and d orbital. Called a 3s, 3p and 3d orbital.

The N, O, P and Q shells each contain an s, p, d and f orbital. Called a 4s, 4p, 4d, 4f, 5s, 5p, 5d, 5f, 6s, 6p, 6d, 6f, 7s, 7p, 7d and 7f orbital.

These [orbitals](#) also have various sub-orbitals.

The s orbital can contain only 2 electrons and has no sub-orbitals.

The p orbital can contain 6 electrons, 2 in each of its 3 sub-orbitals, like p_x , p_y and p_z .

The d orbital can contain 10 electrons, 2 in each of its 5 sub-orbitals, like d_{xy} , d_{xz} , d_{yz} , d_{z^2} , $d_{x^2-y^2}$.

The f orbital can contain 14 electrons, 2 in each of its 7 sub-orbitals.

(And there is a g orbital that can contain 18 electrons, 2 in each of its 9 sub-orbitals, for highly excited electrons.)

A maximum of 2 electrons can occupy a sub-orbital where one has a spin of UP, the other has a spin of DOWN. There can not be two electrons with spin UP in the same sub-orbital. (Pauli exclusion principal.) Also, when you have a pair of electrons in a sub-orbital, their combined magnetic fields will cancel each other out.

In order to show how many electrons are in each orbital, the following convention is sometimes used:

[Chlorine](#) has $1s^2 2s^2 2p^6 3s^2 3p^5$ for a total of 17 electrons. This tells us that there are 2 in 1s, 2 in 2s, 6 in 2p, 2 in 3s, and 5 in 3p.

Let's look at the pattern of how the [electron orbitals](#) are filled as we move up in the [periodic table of the](#)

[elements](#). (This is a fantastic site on the elements!!!)

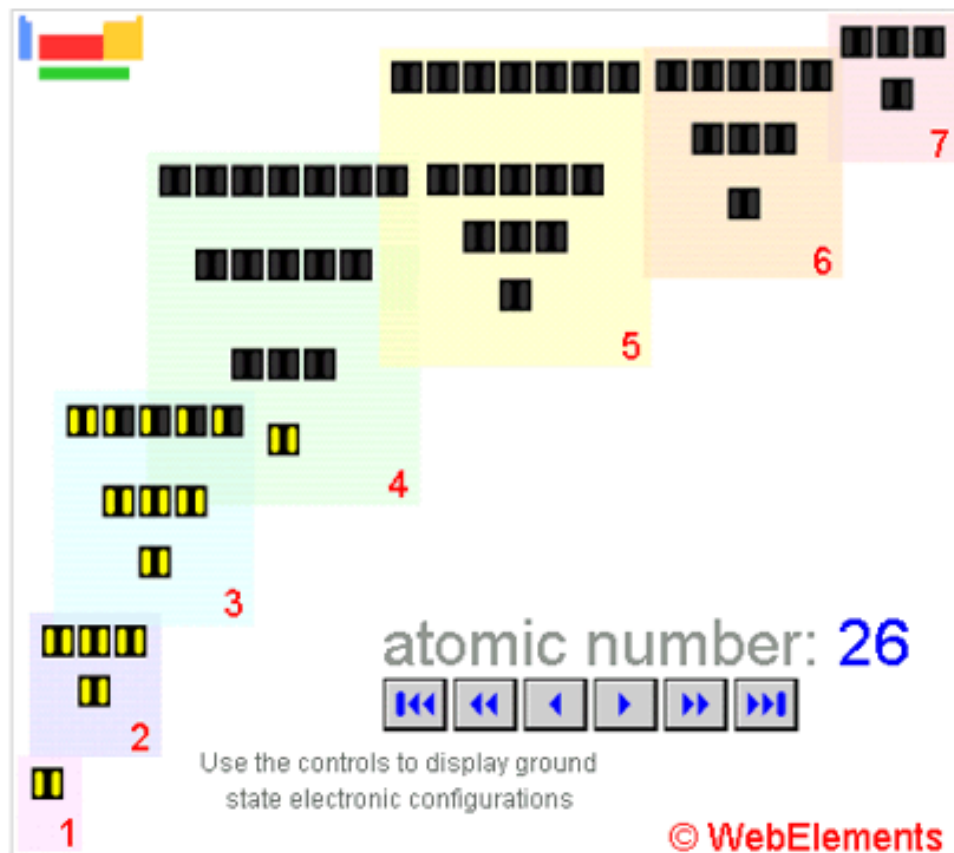

[DIRECTIONS: click on the figure above to go to

<http://www.webelements.com/webelements/elements/text/Fe/econ.html>. Find the box on that page like the one above. Click on the left and right arrow buttons within that box to see how the electron orbitals and sub-orbitals are filled as you step through the periodic table.]

As you can see, the general order for filling the electron orbitals follows a sequence since the energy level for each orbital increases in this sequence:

1s, 2s, 2p, 3s, 3p, 4s, 3d, 4p, 5s, 4d, 5p, 6s, 4f, 5d, 6p, 7s, 5f, 6d, 7p

After each orbital is full, it starts to fill the next one in this sequence. There are a few odd jumps in the sequence when you get to filling the 4f, 5d and 6p orbitals, but that's how it goes.

If we were to examine [Iron](#) (atomic number 26), [Cobalt](#) (27), [Nickel](#) (28) and [Gadolinium](#) (64), all of which are considered ferromagnetic since they are strongly attracted to a magnet, it is difficult to see what makes them so different from the other elements next to them or below them in the periodic table. In other words, if Iron is so strongly magnetic, why isn't Manganese? Perhaps there are other [factors](#) we need to take into account such as the crystalline structure. But it is generally accepted that these ferromagnetic elements have large magnetic moments due to un-paired electrons in their outer orbitals. This is like having current flowing in a coil of wire, creating a magnetic field. Even the spin of the electron is thought to create a minute magnetic field. When you get a bunch of these fields together, they add up to bigger fields.

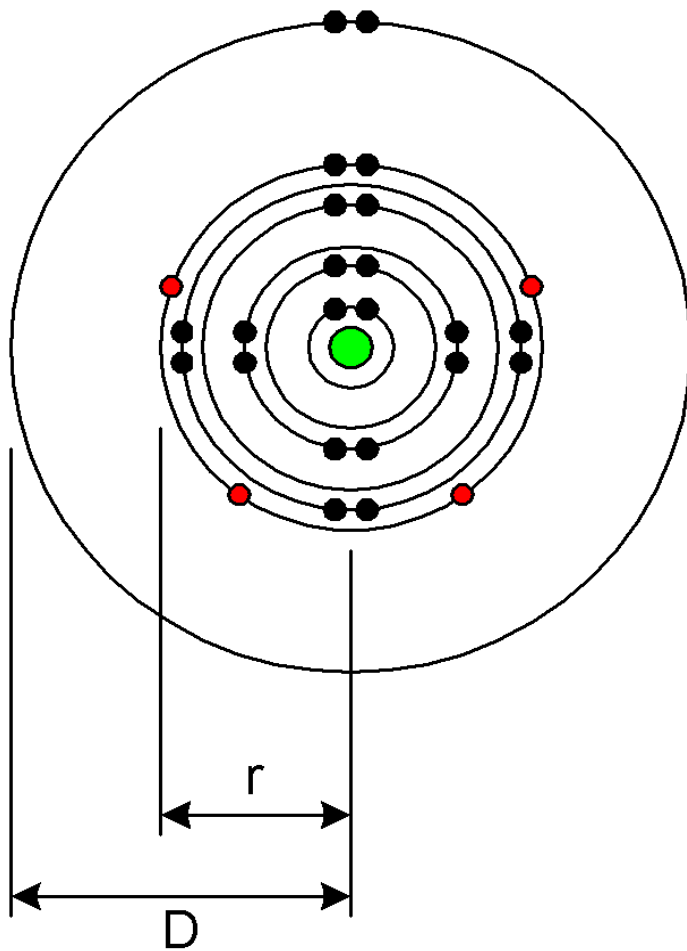

Iron (Fe)

Atomic Number 26

Electron configuration $1s^2 2s^2 2p^6 3s^2 3p^6 3d^6 4s^2$

This shows the electron orbits as circular rings around the nucleus. It really isn't like this, but it makes a good diagram.

The green dot in the center is the nucleus with the 26 protons and 26 neutrons.

The orange dots in the 3d orbital are the 4 unpaired electrons.

The unpaired electrons in 3d create a magnetic moment, or force. It is thought that D/r must be 3 or more to create ferromagnetism. This condition occurs in Iron, Cobalt, Nickel and rare-earth groups.

We can go one level deeper into quantum mechanics. This is where we ask, "What is the magnetic field made of?"

Today, there are four basic forces that are known: gravity, electromagnetism, weak, strong. What creates these forces? There is speculation among particle physicists that these forces are the result of photons that are exchanged between particles. This exchange is what creates a repulsion or attraction between various particles, giving us the forces we call gravity, magnetism, and others that hold the protons together in the center of the atom. For a more in-depth understanding, you will want to read about the Standard Model of the atom at

http://particleadventure.org/particleadventure/frameless/standard_model.html and

<http://particleadventure.org/particleadventure/> and

<http://www.schoolscience.co.uk/content/4/physics/particles/index.html>

Magnetic Domains

1. Magnetic moments in neighboring atoms are held parallel by quantum mechanical forces.

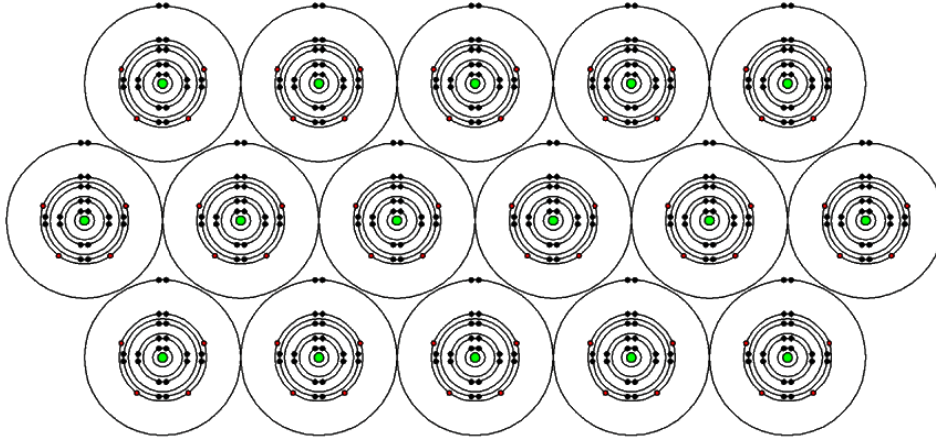

2. These atoms with these magnetic characteristics are grouped into regions called domains. Each domain has its own North pole and South pole.

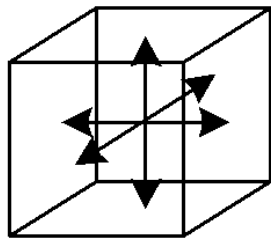

It is equally probable that the magnetism will occur in any one of the six directions.

Magnetic Domain

A Domain is the smallest known permanent magnet. About 6000 domains would occupy an area the size of the head of a common pin.

A domain is composed of approximately one quadrillion (1,000,000,000,000,000 or 10^{15}) atoms.

3. In unmagnetized ferromagnetic materials, the domains are randomly oriented and neutralize each other or cancel each other out. However, the magnetic fields are still present within the domains!

(These diagrams show domains as small cubes or squares - kind of a micro view.)

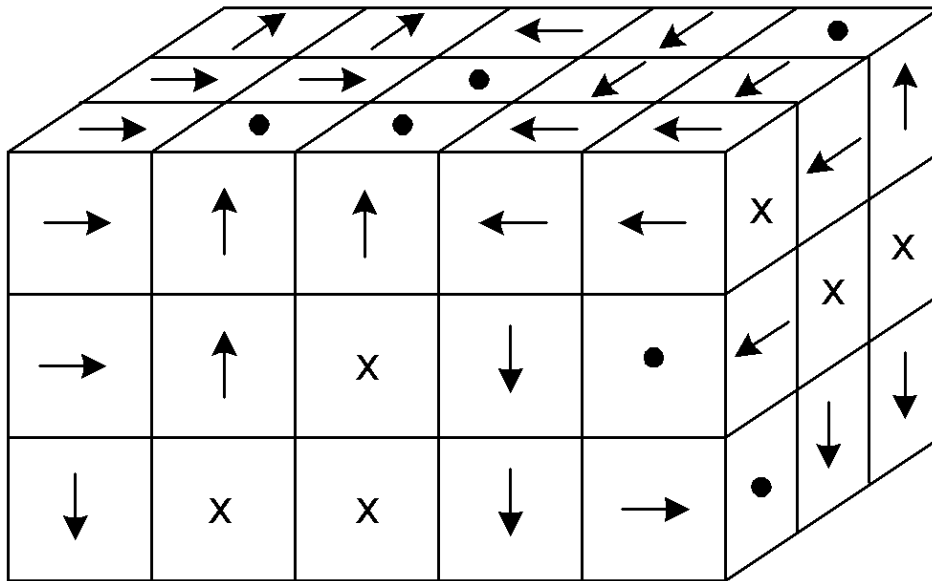

Here is a sample of unmagnetized iron, showing its domains in random magnetic orientations (x is arrow away from you = South Pole, dot is arrow toward you = North Pole)

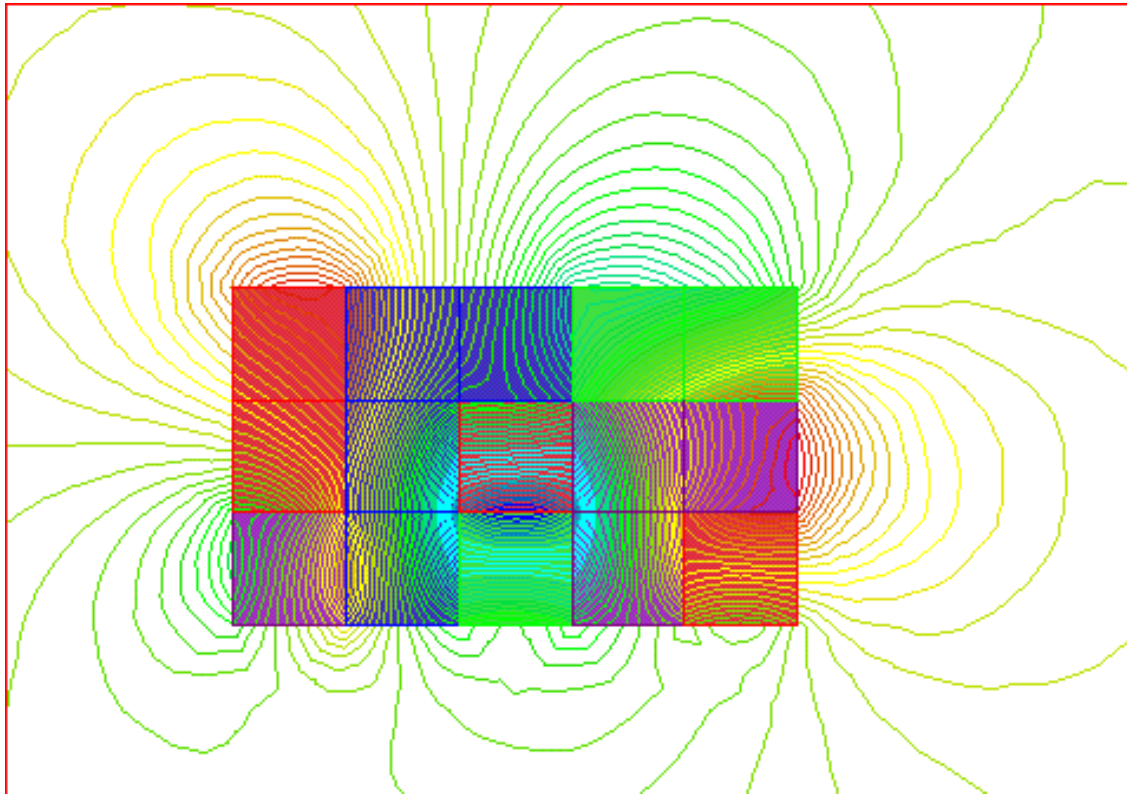

This shows the magnetic field around that sample of unmagnetized iron with its groups of domains, like those noted above, with random orientations. As you can see, this sample has multiple North and South poles where the magnetic field lines exit and enter the material.

4. The application of an external magnetic field causes the magnetism in the domains to become aligned so that their magnetic moments are added to each other and lined up with the applied field.

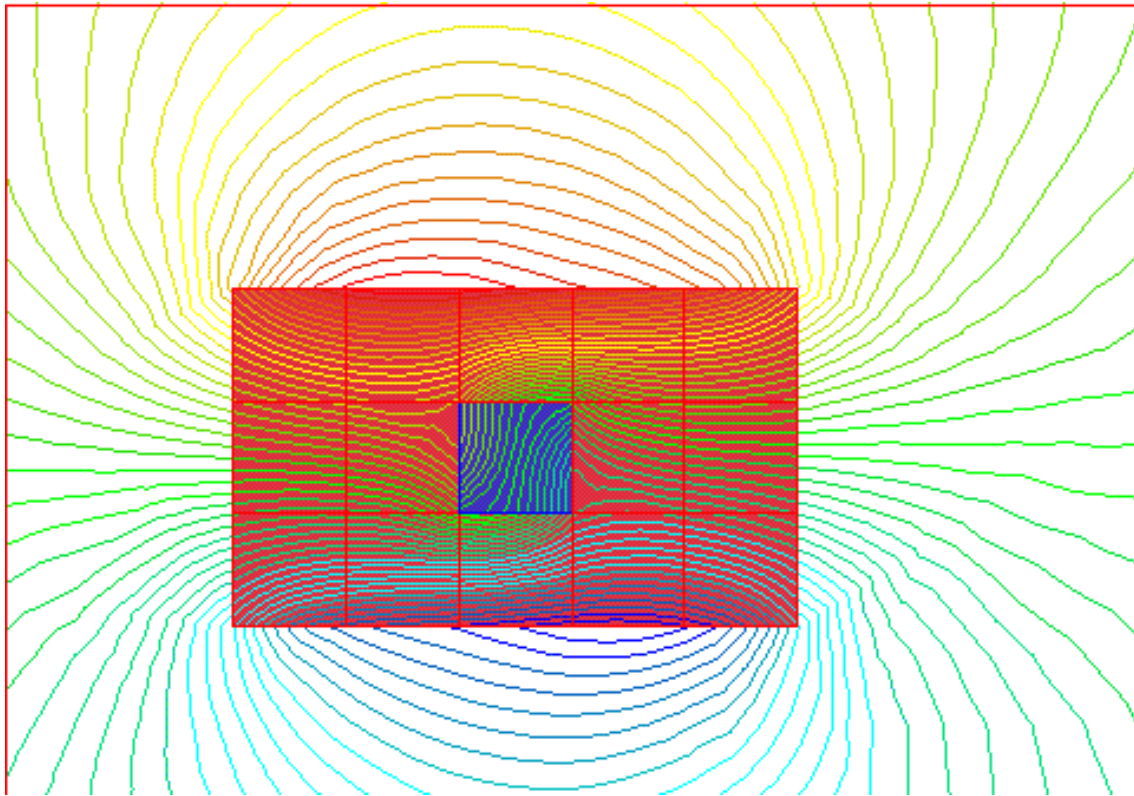
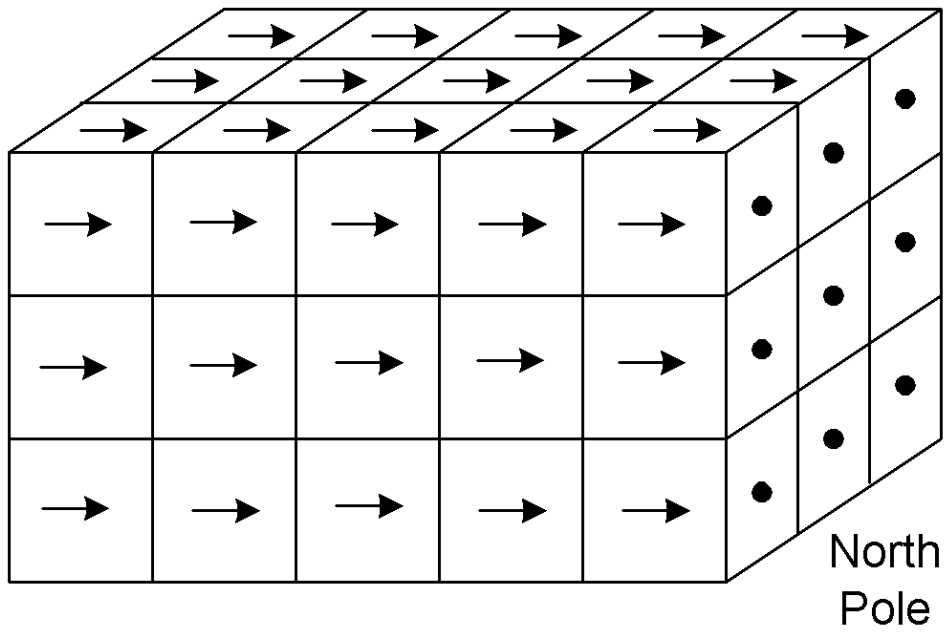

This shows the magnetic field around a group of domains, where all but one is oriented in the same direction.

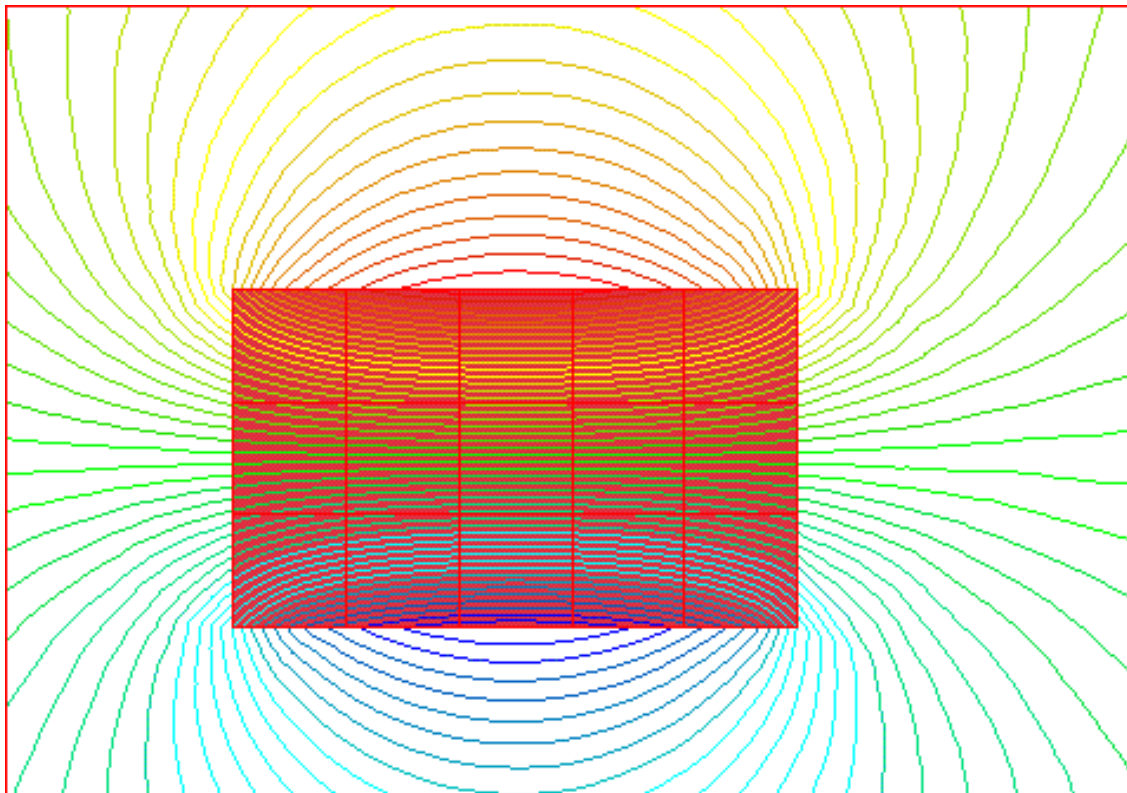

And this shows the magnetic field around a group of domains that are all lined up together.

With soft magnetic materials such as iron, small external fields will cause a great amount of alignment. However, because of the small restraining force only a little of the alignment will be retained when the external field is removed.

With hard magnetic materials such as Alnico a greater external field must be applied to cause alignment of the domains, but most of the alignment will be retained when the field is removed, thus creating a stronger permanent magnet, which will have one North and one South pole.

If we were to look at this from more of a macro level, a level at which we have actually seen under microscopes, we would see larger domains - not as cubes or squares, but more like irregular polygons.

If you were to examine a piece of iron that is not magnetized, you will find that the domains within the iron will not be pointing in the same direction, but will be pointing in a bunch of random directions. This randomness is what causes the magnetic field of each domain to be cancelled out by the magnetic field of another domain. The result is that there is no single north pole or south pole. Instead, there are a bunch of north and south poles all over the place that cancel each other out.

Now, if this piece of iron were placed within an external magnetic field (created by current flowing in a solenoid), the domains will start to line up with the external magnetic field. It takes some energy to cause a domain to re-orient itself. As the external magnetic field becomes stronger, more and more of the domains will line up with it. (Another way to look at it is that the domains that are aligned with the external magnetic field will grow in size, and the others will shrink.) There will be a condition where all of the domains within the iron are aligned with the external magnetic field. This condition is called saturation, because there are no more domains that can be lined up, no matter how much stronger the magnetic field is made.

(These diagrams show domains as irregular polygons - more of a macro view.)

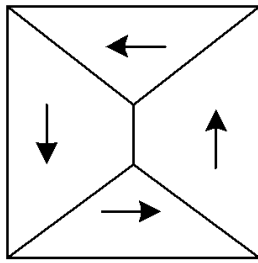

no external mag field
saturation of domains

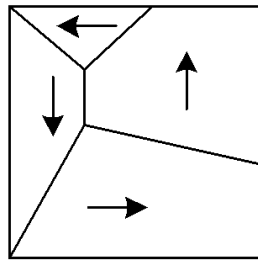

small mag field

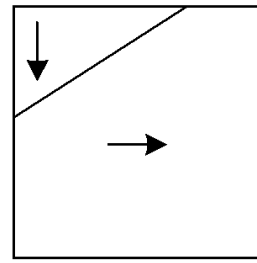

larger mag field

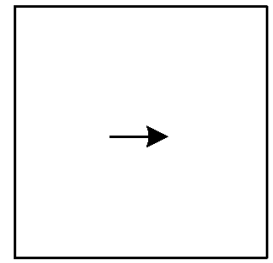

large mag field,

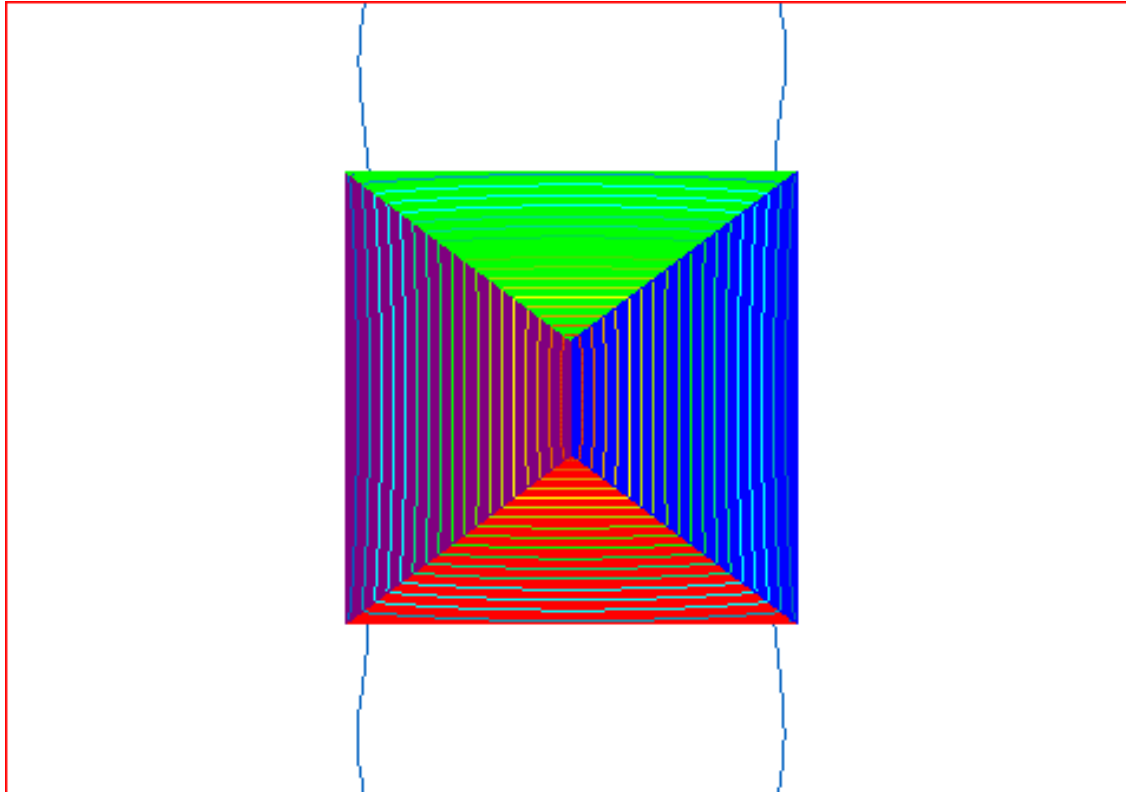

Resulting magnetic field with the domains as indicated above with no external mag field.

Note that the domains still have their own magnetic field, but that the field lines stay almost exclusively within the material.

Very little leaks out of the material. This would be an example of unmagnetized iron.

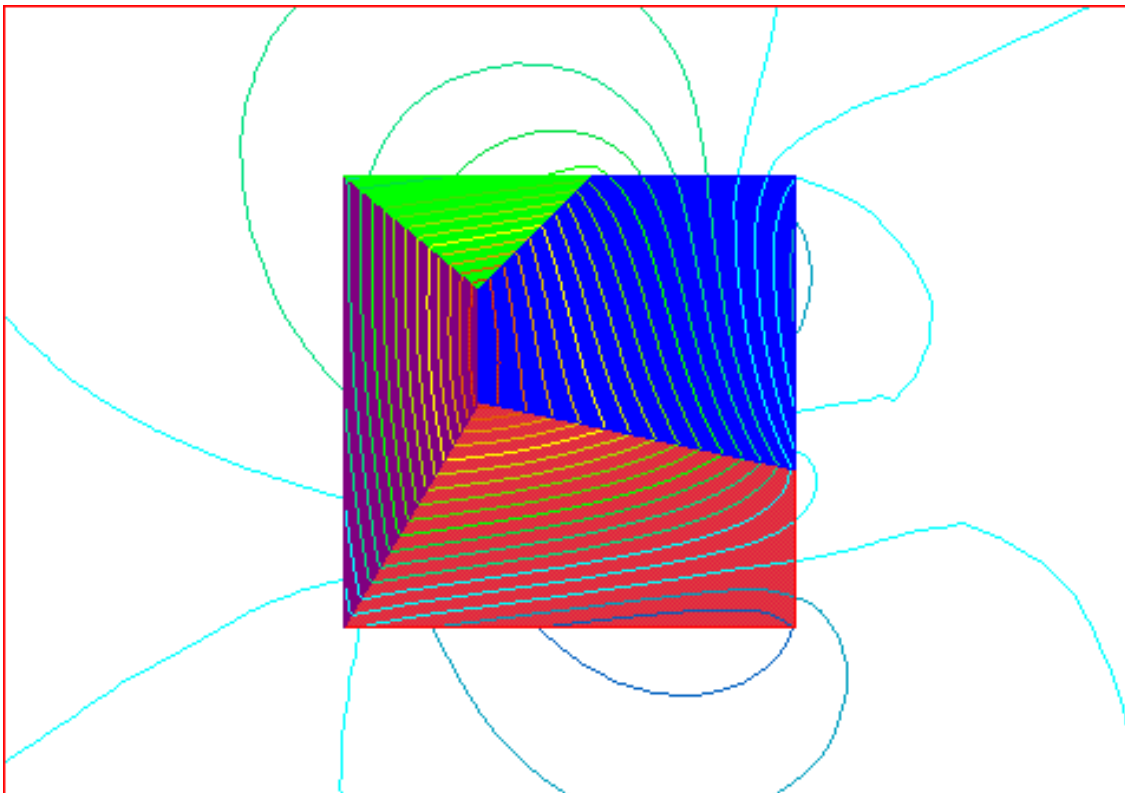

Resulting magnetic field with the domains as indicated above with small mag field. This has two north poles (lower right and upper right) and one very spread-out south pole (on the left).

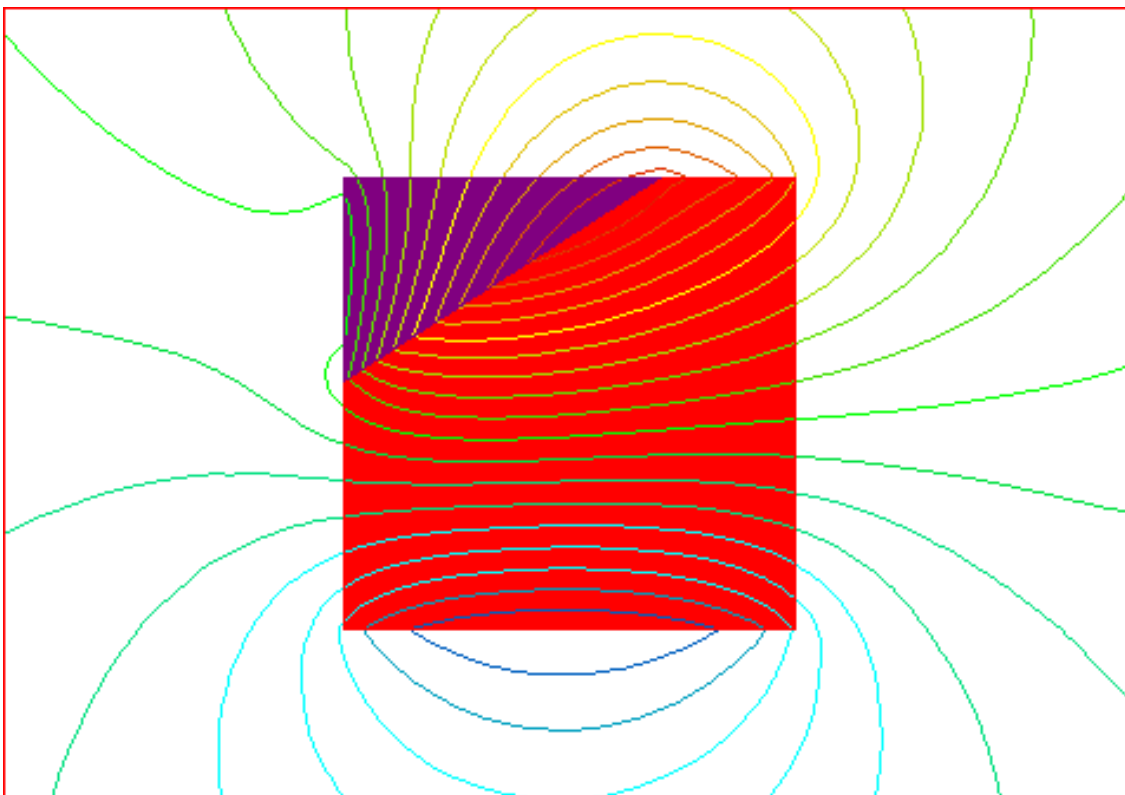

Resulting magnetic field with the domains as indicated above with larger mag field. Starting to look more like a magnet with a defined north and south pole.

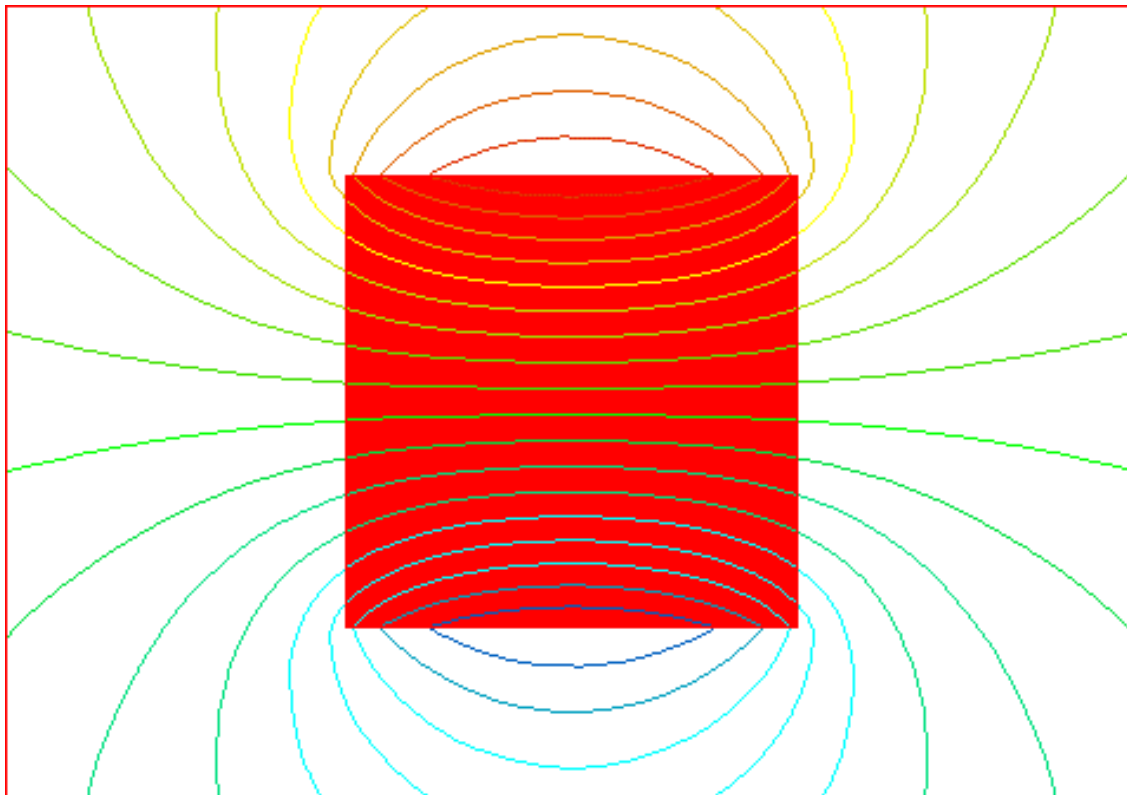

Resulting magnetic field with the domains as indicated above with large mag field, saturation of domains. This is what a permanent or temporary magnet would typically look like.

What happens when the external magnetic field is reduced back to zero? In a soft magnetic material (such as iron or silicon steel), most of the domains will return to their random orientations, so that you will be left with a very weak magnet since only a few of the domains will be lined up in the same direction. In other words, you are back where you started from. In a hard magnetic material (alloys of iron such as Alnico, some steels, neodymium-iron-boron, etc), most of the domains will remain aligned, so that you will be left with a strong magnet. Since the ending point is not the same as the starting point for magnetic materials, they have what is called hysteresis.

Magnetic Poles

1. A freely suspended bar magnet will always tend to align itself with the North and South magnetic poles of the earth. An example of this is the magnetic compass.

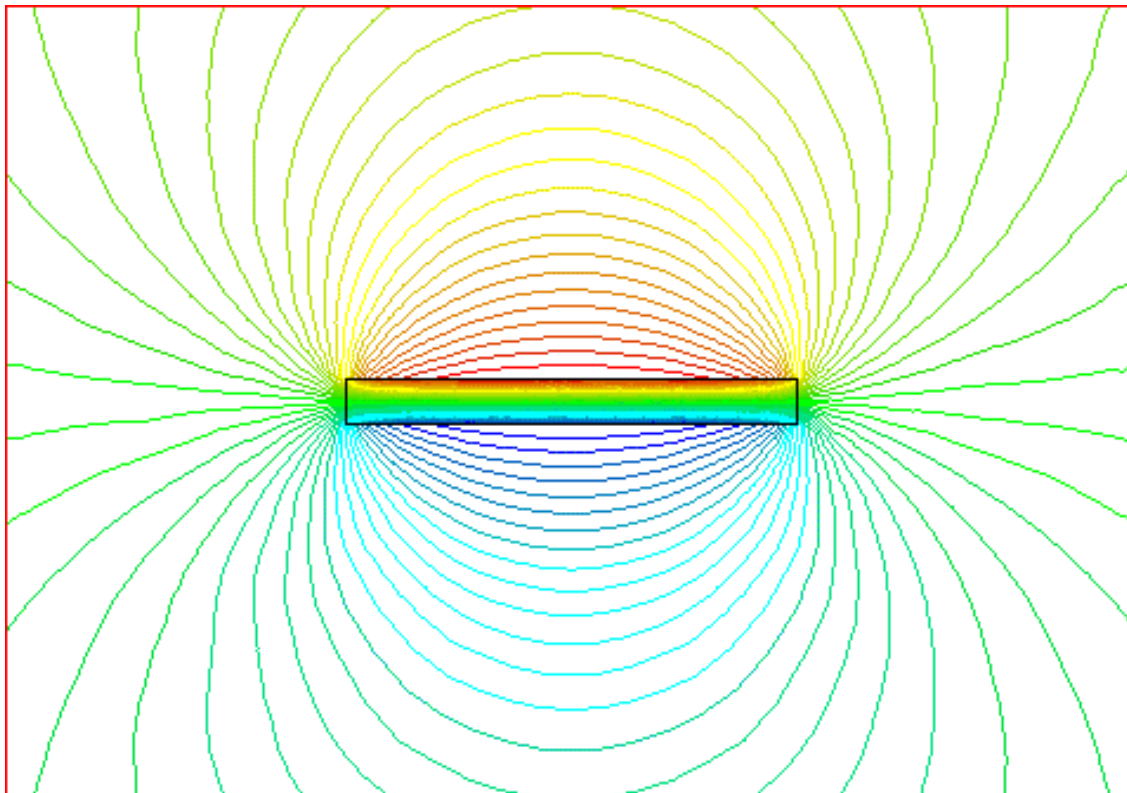

This shows the magnetic lines of force for a long, narrow bar magnet. North is on the right end.

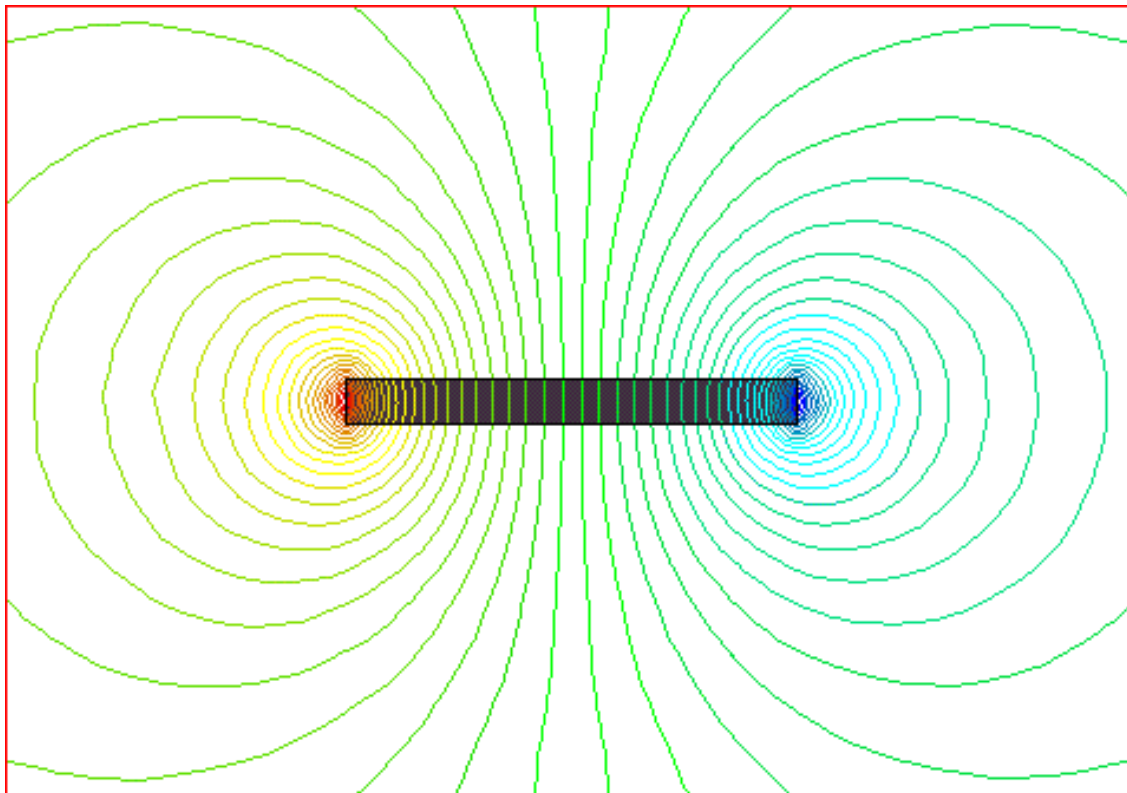

This shows the magnetic lines of force for a flat, wide magnet. North is on top.

Note the concentration of lines where they exit or enter the magnet, at the ends. This is what defines a pole. Since magnetic fields are like rubber-bands, and since they like to crowd into ferromagnetic material whenever it can, they bunch up inside the magnet. Again, since the field lines are like closed loops, there is always some place where they enter the magnet (South pole), and some place where they exit the magnet (North pole). These places are the poles. The magnetic field lines tend to be closest together there. This is why, if you break a magnet in half, you will still have a North pole and a South pole, since the lines enter one magnet, then exit it, then enter the next magnet, then exit it, before it goes

back to the first magnet again. This is also why we can't have a "monopole" or single pole. If the magnetic field line exits the magnet, somewhere it will have to enter it again - the loops are closed like rubber-bands. The minimum number of poles a magnet can have is two - one each of North and South. However, it is possible for a magnet to have more than two poles, right? Look at the pictures above again, where we have a lot of random square domains. See all the poles all around the periphery of the group of domains? I count about 10! Below is a magnet with 8 poles.



This magnet has 8 poles, or 4 pole-pairs.

A compass in the vicinity of a magnet will always point along a tangent to one of the magnetic field lines.

This occurs because unlike poles of a magnet are always attracted to each other by the invisible lines of force whereas like poles repel each other. The earth acts like a large permanent magnet. In fact, the earth is the largest magnet in the world. But don't forget the sun that also has a magnetic core, and so do collapsed stars, and they are bigger than the earth! I wouldn't call the earth a permanent magnet like other magnets we are used to. Its magnetism is the result of electron convection currents in the liquid core, and they have flipped around a few times in the past, just like what the sun does every 11 years. So, it's really more like an electromagnet.

2. Permanent magnets can be designed and engineered in hundreds of shapes and sizes to perform various tasks.

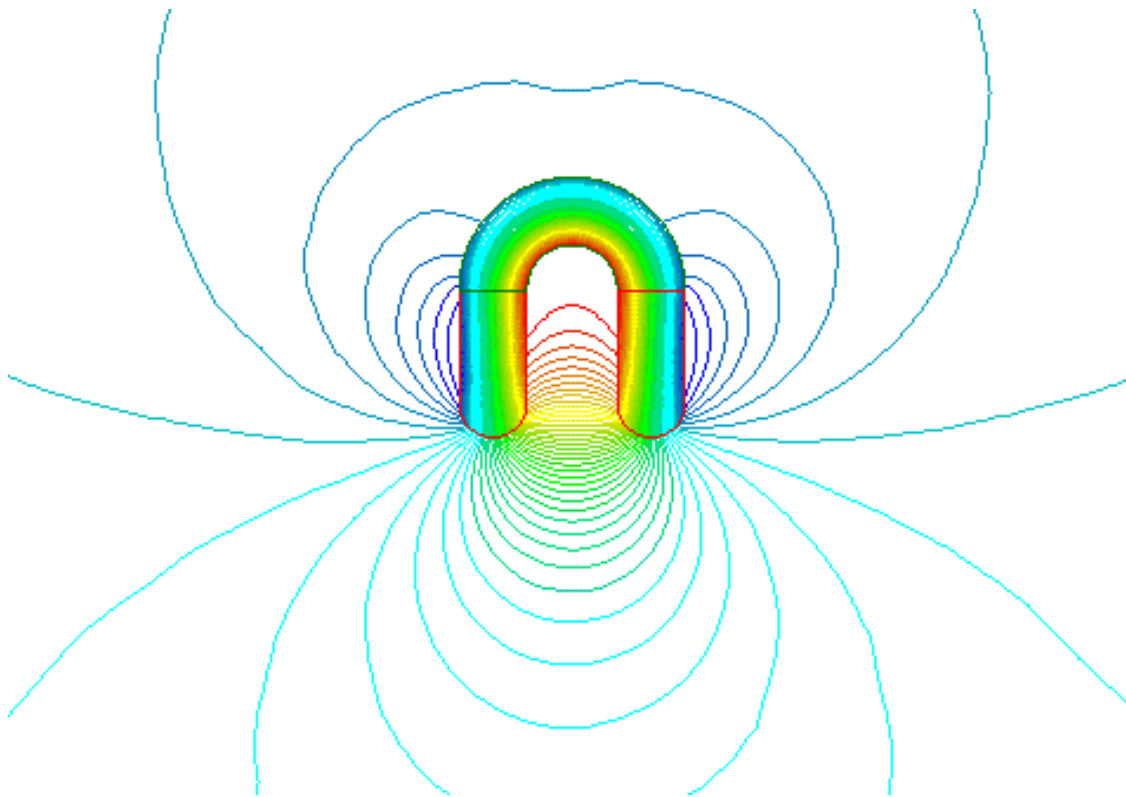

For example, the horse-shoe shape is very commonly used in magnetic separators because its lines of force are mostly at the open end of the horse-shoe, and this helps in the separation of ferrous materials. A piece of iron placed within the effective range of the magnetic field will, in turn become magnetized. It will have its own North and South poles and will be attracted to the permanent magnet.

Summary

What all this is saying, is that the atoms of ferromagnetic materials tend to have their own magnetic field created by the electrons that orbit it.

Small groups of about 10^{15} atoms tend to orient themselves in the same direction. These groups are called domains. Each domain has its own north pole and south pole.

If you were to examine a piece of iron that is not magnetized, you will find that the domains within the iron will not be pointing in the same direction, but will be pointing in a bunch of random directions. This randomness is what causes the magnetic field of each domain to be cancelled out by the magnetic field of another domain. The result is that there is no single north pole or south pole. Instead, there are a bunch of north and south poles all over the place that cancel each other out.

Now, if this piece of iron were placed within an external magnetic field (created by current flowing in a solenoid), the domains will start to line up with the external magnetic field. It takes some energy to cause a domain to re-orient itself. As the external magnetic field becomes stronger, more and more of the domains will line up with it. (Another way to look at it is that the domains that are aligned with the external magnetic field will grow in size, and the others will shrink.) There will be a condition where all of the domains within the iron are aligned with the external magnetic field. This condition is called saturation, because there are no more domains that can be lined up, no matter how much stronger the magnetic field is made.

When the external magnetic field is then removed, soft magnetic materials will become randomly oriented domains again. However, hard magnetic materials will keep most of their domains aligned, making it a strong permanent magnet.

Magnetic field lines are closed loops. They enter a magnet at its South pole, and exit a magnet at its North pole. The poles may cover a large area, where the concentration of lines is not uniform.

Scientific Disciplines

Did you notice all of the scientific disciplines that are involved with magnets? I'll list the ones I can think of, perhaps you can add some to this list.

quantum mechanics

probability theory

particle physics

chemistry

mathematics

material science

electrical engineering

application engineering

those-who-like-to-play-around-with-magnets engineering

NOTE:

Some of the material shared above was originally presented by Arlo F. Israelson, Chief Engineer at Eriez Manufacturing Co., in Erie, Pennsylvania, USA, dated 9/12/52. This was found in Permanent Magnet Design and Application Handbook, by Lester Moskowitz, Cahners Books International, Boston, MASS 1976, in Chapter 6, Fundamentals of Magnetism. The illustrations and additional notes are mine, patterned after his presentation.





Experiments with magnets and our surroundings

What do magnetic fields look like?

What is a magnetic field?

A magnet produces a vector field, the magnetic field, at all points in the space around it. It can be defined by measuring the force the field exerts on a moving charged particle, such as an electron. The force (F) is equal to the charge (q) times the speed of the particle times the magnitude of the field (B), or $F = q \cdot v \times B$, where the direction of F is at right angles to both v and B as a result of the cross product. This defines the magnetic field's strength and direction at any point.

What creates the magnetic field?

A magnetic field can be created with moving charges, such as a current-carrying wire. A magnetic field can also be created by the spin magnetic dipole moment, and by the orbital magnetic dipole moment of an electron within an atom.

What is the relationship between current flow and magnetic fields?



This is the **Right Hand Rule** for magnetic field from flowing current, and for

magnetic field from coil.

When current flows in a wire, a magnetic field is created around the wire. To visualize this, take your right hand, curl the fingers, and stick the thumb straight out. Now, point your thumb in the direction of the current flowing in the wire (using conventional current where current flows from the + end of a battery to the - end of the battery. NOTE: electrons flow from the - end of a battery to the + end, and is called electron current instead of conventional current). The direction your fingers are curved around the wire is the direction of the magnetic field around the wire. For example, if the current were coming straight out of this page toward you, your thumb would be pointing toward you and your fingers would indicate a counter-clockwise direction to the magnetic field around the wire.

If you have a coil of wire, simply curve the fingers of your right hand around the coil in the same direction as the current is flowing. Your thumb will point out of the north magnetic pole which the coil of wire will create.

By convention, we state that the magnetic field has a direction associated with it, such that the field exits the North end of a magnet, flows through the air or other materials nearby, and re-enters the South end of the magnet. Inside the magnet, the field flows from the South back to the North.

In summary, current flows from + to - of a battery, and magnetic fields flow from the North to the South of a magnet.

What do we know about magnetic field lines?

Magnetic field lines are a way to visualize the magnetic field. When drawn, the distance between them is an indication of the strength of the field. The closer they are, the stronger the field. For example, the number of lines per square centimeter is a measure of the strength of the magnetic field.

Specifically, 1 Gauss is equivalent to 1 magnetic field line within 1 square centimeter. Also, the direction of the tangent to the field line is the direction of the magnetic field at that point.

What are magnetic fields made of?

A tremendous amount of research has gone into the area of elementary particle

physics - the study of the basic building blocks of all the matter we know of. We used to think that electrons, protons, neutrons and photons were all there was. However, we then discovered a host of other particles which make up the protons and neutrons. [Today](#), we know of 12 particles and 4 electroweak forces and 1 strong force. They are:

Fermions (matter carriers)		Bosons (force carriers)	
Leptons	Quarks	Unified Electroweak	Strong
electron neutrino	up	photon	gluon
electron	down	W-	
muon neutrino	charm	W+	
muon	strange	Zo	
tau neutrino	top		
tau	bottom		

So, how does one magnet feel the presence of another magnet when they approach each other? I don't think physicists really know the answer to that. They know that the electromagnetic field is actually made of an enormous number of photons, but do virtual, massless photons make up the magnetic field, and how does one field affect other magnetic fields at a distance, and does the magnetic field travel at the speed of light like gravitational waves? Perhaps you will be the one to discover some of these answers.

Two excellent books on how we got from electrons, protons, neutrons and photons to all of the above are:

"Interactions," Sheldon Glashow, Warner Books, 1988, ISBN 0-446-38946-3

"The Elegant Universe," Brian Greene, Vintage Books, 1999, ISBN 0-375-70811-1

How can I visualize the magnetic field? EXPT

[Ansoft Corporation](#) has a great software package which can simulate the fields and forces surrounding permanent magnets and electromagnets. The following diagrams show the results of some simulations created using the Ansoft Maxwell 2D Field Simulator program. (Maxwell is a registered trademark). Check their web site to obtain your own, **FREE** [Student Version](#) of this program!!!

- [Single bar magnet](#)
- [Two bar magnets end to end, N to S, with a gap between them](#)
- [Two bar magnets end to end, N to N, with a gap between them](#)
- [Two bar magnets end to end, S to S, with no gap between them](#)
- [Two bar magnets side by side, N by N, with a gap between them](#)
- [Two bar magnets side by side, N by S, with a gap between them](#)
- [DC electromagnet with an air core](#)
- [DC electromagnet with a soft iron core](#)
- [DC electromagnet with a soft iron core, with a small permanent magnet below it](#)
- [Single donut magnet](#)
- [Group of six donut magnets, three stuck together, three levitated above](#)
- [Levitating train platform above its magnetic tracks](#)
- [Two disk magnets, stuck together, about to be slid apart](#) (sometimes this is the only way to pull two NIB magnets apart)
- [Two hemispherical magnets](#), with a gap between them
- [A spherical magnet](#), like the earth's core

Some new field diagrams for the future:

- The Levitron toy
- A magnet levitating above a superconductor
- A horseshoe magnet with and without a keeper
- Magnetic shielding effects using sheets of iron, copper, mu-metal

- Different ends on an electromagnet for lifting
- Magnetic separator
- Helmholtz coil assembly
- Halbach array (Magic cylinder arrangement)
- Trying to make a magnetic monopole
- Speaker magnet
- Electromagnetic pot assembly

Here is a link to another [software vendor](#) whose program can also show what the magnetic fields inside motors and generators look like as the rotor is turning, in an animation. Check out their Products section, especially the Flux2D program. Very cool!

This is a drawing of a single magnet all by itself showing what magnetic field lines look like:

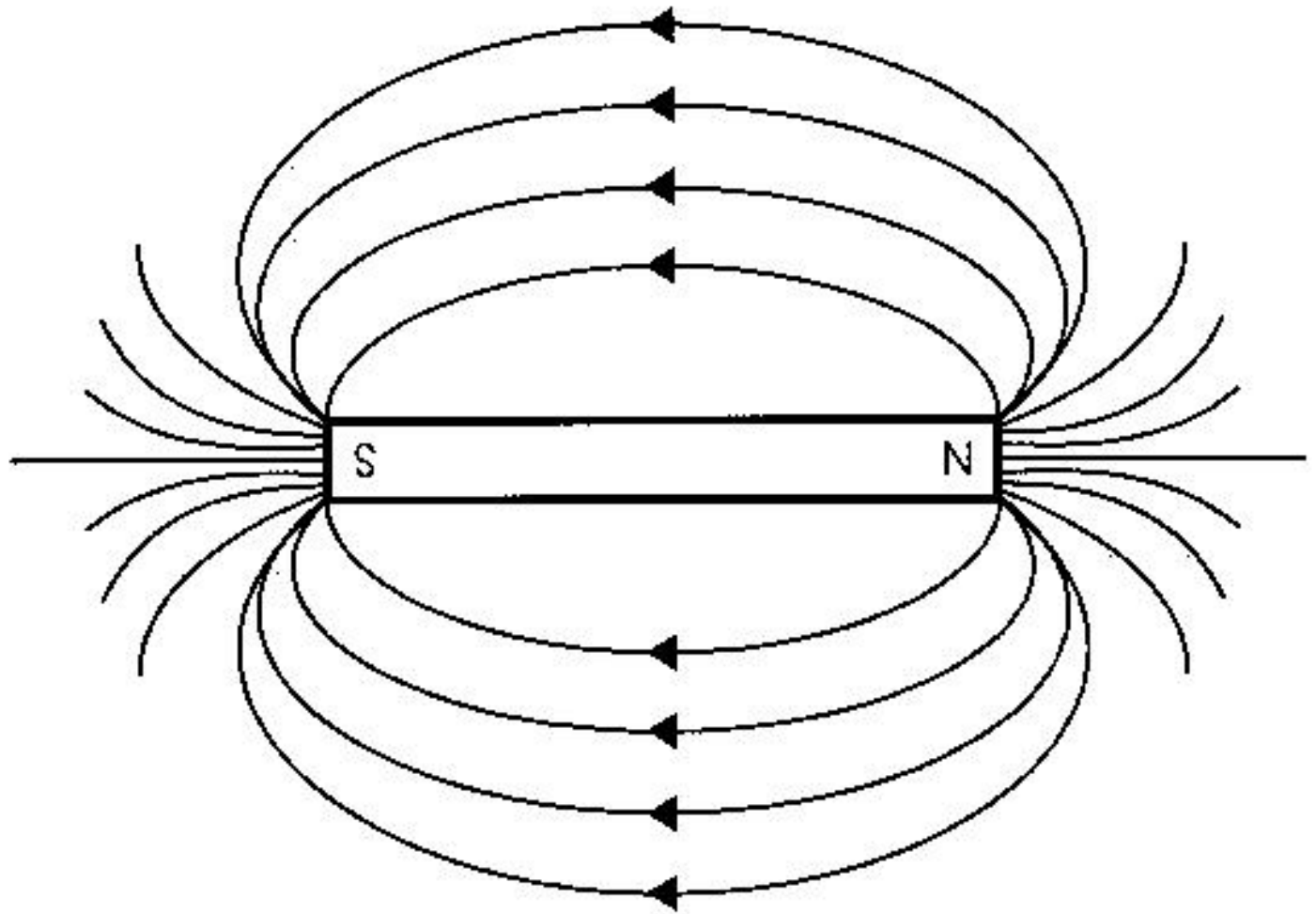

Now, compare this to the diagrams in the links above from an accurate simulation. You can see these magnetic fields yourself by placing a magnet under a piece of paper and sprinkling iron filings onto the paper. Spray the paper with Krylon to make the iron filings stick in place. They will trace out the field lines just like the drawing above. Or, get a [plastic box](#) with iron filings in it, and place a magnet under the box. Or, put a magnet into a [Mysterious Magnet Tube](#) to see the iron filings surround the magnet in the middle.

What can shield a magnetic field? **EXPT**

This makes a great science fair project!

1. The goal is to determine what can shield a magnetic field.
2. You will need a source of a magnetic field, such as an electromagnet or a strong rare-earth magnet.
3. Next, you will need a way to determine if the magnetic field has changed strength. Certainly a

sure way to do this is to measure the flux using a Gaussmeter. Another method is to use a compass to see if it is still affected the same way it was before the proposed shield was put in place.

4. Finally, you will need some plates of various materials to try as shields. I would recommend: wood, plexiglas, styrofoam, brass, copper, aluminum, steel, iron, paper, stainless steel, and any other materials you think may work.

5. Measure the strength of the magnetic field about 2" away from the magnet. Note the value of the meter or response of the compass. Keep the meter probe or compass in one position during the experiment.

6. Place the material between the magnet and the probe or compass and see what happens. Note the material and the result.

7. What you'll find is that only steel and iron will work as a shield. If it is very thin, it's effectiveness is decreased.

References to shielding: <http://www.magnetic-shield.com/>
<http://www.mushield.com/index.html>
<http://www.advancemag.com>

Here's a project that did the above.

A Science Fair Project

Here is a science fair project which covered four areas:

1. A Hall-Effect [Gaussmeter](#) for measuring the strength of magnetic fields
2. A selection of magnets to compare their strengths using the Gaussmeter
3. Two electromagnets, one DC and one AC, with a variable control on them, to see how their strengths are adjustable
4. Various plates of metal to see how well they shield magnetic fields (as described above)



This shows the box with the equipment inside, and the display material.



This is a close-up of the Gaussmeter equipment in the top half. The voltmeter is on the left. The circuitry is in the middle on a breadboard. The power supply is on the right.

The bottom half is a collection of various types of magnets, all under plexiglas.

The probe is at the end of the cable laying on top. By taking the probe and holding it over the various magnets, we are able to measure the strength and polarity of the magnets.



This shows the electromagnets on the left. There is a DC electromagnet at the bottom, an AC electromagnet in the middle, and a variac for controlling the voltage to them at the top. The Gaussmeter probe can also measure the strength of these electromagnets, and their polarities. (The AC electromagnet indicates both a N and a S pole, since it is switching between them 60 times a second.)



This is a collection of metal plates which can be placed over a magnet or electromagnet, and the strength of the magnetic field on the top side of the plate can be measured, determining how well it shields the magnetic field. The

plates are made of steel, aluminum, brass and copper.

Results of the shielding experiment were:

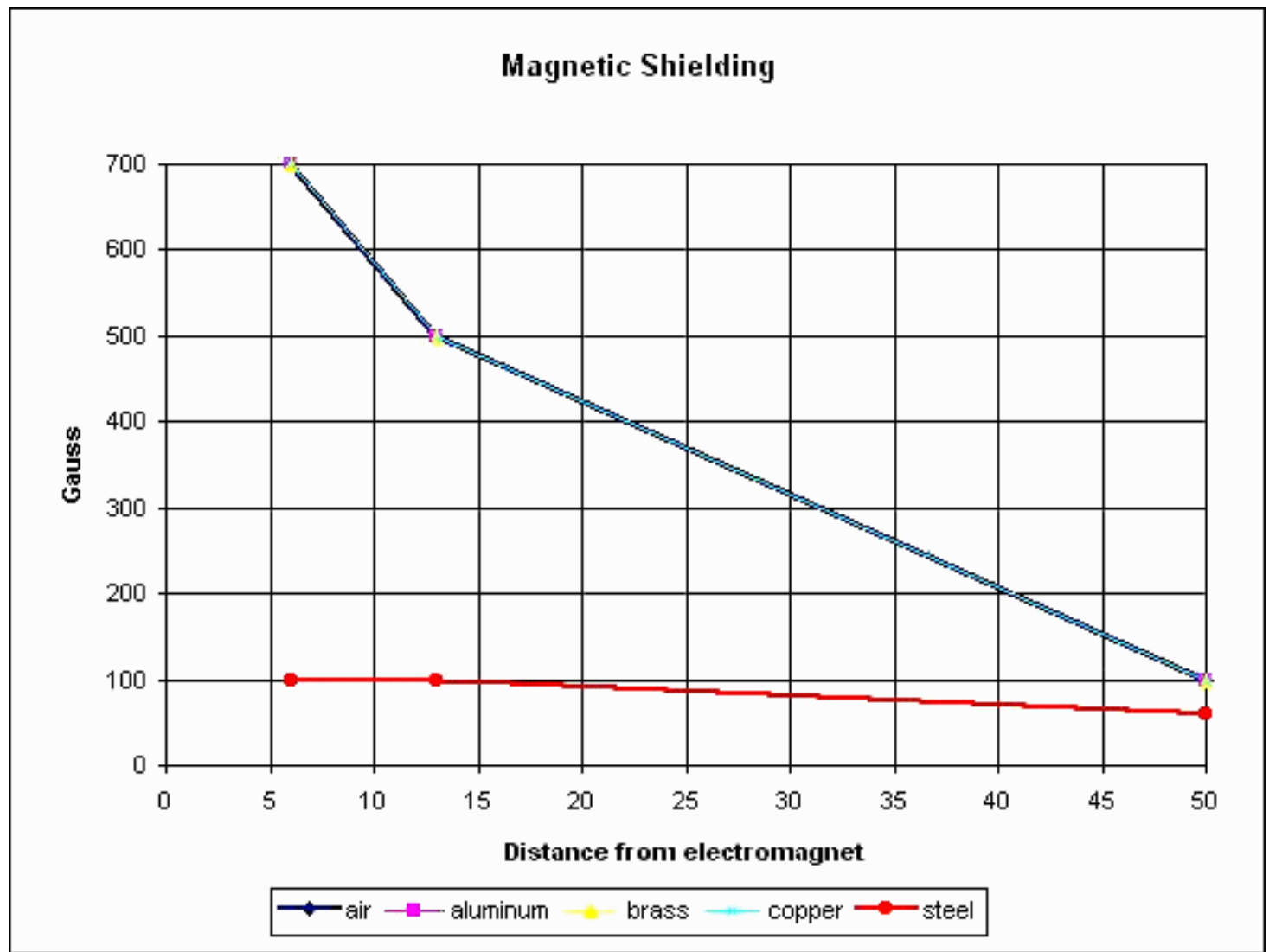

Gauss readings

Distance between probe and electromagnet

Material	6	13	50 mm
air	700	500	100
aluminum	700	500	100
brass	700	500	100
copper	700	500	100
steel	100	100	60

What do magnetic fields look like?



If you want to skip the pictures of fields around magnets, go here to the next section:

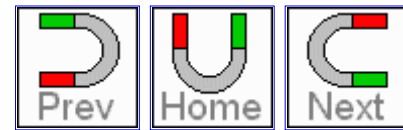

Experiments with electronics

Build your own Gaussmeter EXPT

Have you ever wanted to find out how strong a magnet really was, or how the strength of the magnetic field varied as you changed the distance from the magnet or the temperature of the magnet, or how well a shield placed in front of the magnet worked? Voltmeters are fairly inexpensive and easy to find, but where do you purchase a Gaussmeter (also known as a magnetometer). I built a hand-held Gaussmeter for measuring the polarity and strength of a magnetic field. It uses a linear [Hall effect device](#) and some op-amps and resistors and things from [Radio Shack](#).

I will first describe a very simple, inexpensive Hall effect device Gaussmeter you can build for as little as \$6. Then I will describe a Gaussmeter with a few more bells and whistles.

An inexpensive Hall effect Gaussmeter EXPT

Here is a parts list for the low-cost Gaussmeter:

<u>Description</u>	<u>Qty</u>	<u>Radio Shack P/N</u>	<u>Approximate Cost, each</u>
9v Battery	1		
Battery Clips	1	270-325	1.39/5
7805 Voltage Regulator	1	276-1770A	1.49
Uncalibrated Hall Effect Device -or- Uncalibrated Hall Effect Device -or- Calibrated Hall Effect Device	1	(see text) RSU 12035713 RSU 12033684	2.01 4.79 59.99
IC Breadboard -or- Perf circuit board	1	276-175 276-150A	7.99 1.19
Digital voltmeter, 3-1/2 digits	1	22-802	24.99 or more

First, you need a 9v battery. You can get them most anywhere.

Next is a battery clip to connect to the top of the battery. You get a package of 5 for \$1.39.

The 7805 is a +5v regulator which takes the +9v from the battery and reduces it to +5v which the Hall effect device will need. It only costs about \$1.49.

You have a couple of choices for the Hall effect device. If you go with a calibrated unit, it will cost a lot more, about \$60. With this, though, you get the device and a calibration chart, which tells you exactly what the output voltage is going to be when a certain magnetic field strength is present. These photos show you what you get:

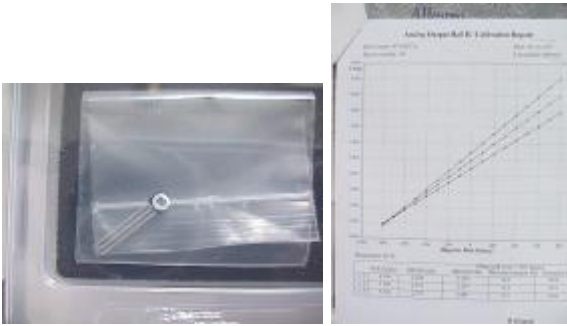

On the left is the Hall effect device, an Allegro A3516LUA. On the right is the calibration chart, showing output voltage from the Hall device vs magnetic field, plotted every 100Gauss from 800Gauss north to 800Gauss south, at three different supply voltages.

Another choice is to purchase an uncalibrated Hall device, take a good guess at the calibration, but still use it for accurate comparisons from one test to another. It just wouldn't have an absolute accuracy. To obtain this, There are a couple of easy choices.

1. Purchase a Radio Shack RSU 12035713 for \$4.79. This is an Allegro A3515EU. It has a sensitivity of 5.0 mV/G, and does not have a calibration chart. (This is great for weak magnetic fields, but may saturate when measuring strong NIB magnets up close. To use this with the stronger magnets, you will need to keep the magnet about an inch away from the Hall device. The device will not be damaged if a very strong magnet is placed against it, the only thing that will happen is that the output of the device will reach a certain voltage limit when the magnet is, say, a half inch away, and the voltage will not change as the magnet gets closer, since its amplifier is saturated. The voltage will again drop as the magnet is moved further away again.)

2. Purchase an Allegro A3516LUA, but without the calibration chart, from [Arrow Electronics](#), for about \$2.01. It has a sensitivity of 2.5 mV/G.

Allegro can be reached directly at:

[Allegro](#)

115 Northeast Cutoff
Worcester, MA 01615
Phone: 508-850-3325
Fax: 508-853-7895

You will need something to mount these parts onto, so here again are two possibilities. Use an inexpensive perf board and solder the parts to it, or use the breadboard and just plug the parts in - no soldering! Unless you've built electronic things before, I would recommend the breadboard since it is easy to use, easy to change, and can be used for other projects in the future. So that would cost \$7.99.

You need a voltmeter for all the projects you're going to work on anyway, so I won't add that in for this project. There are different types available, and their cost goes up with features and functions. A basic one that will work well is noted in the table above.

There! Going with the perf board, it is only \$6.08!!! With the A3515EU from Radio Shack and the breadboard, it will be about \$16! These will have great relative accuracy! For better absolute accuracy, it will cost about \$71. (Again, batteries and voltmeter not included.)

Now, how do you make it?

Connect the + (red) of the battery clip to the input of the 7805 (pin 1).

Connect the - (black) of the battery clip to the common of the 7805 (pin 2).

Connect the +5V input of the Hall device (pin 1) to the output of the 7805 (pin 3).

Connect the common of the Hall device (pin 2) to the common of the 7805 (pin 2).

Set the voltmeter to read 20Vdc max.

Attach the + of the voltmeter to the output of the Hall device (pin 3).

Attach the - of the voltmeter to the common of the 7805 (pin 2) or the common of the Hall device (pin 2).

You are now ready to snap a battery onto the battery clip.

Here's a schematic of the circuit (using the 3503 Hall-Effect Device):

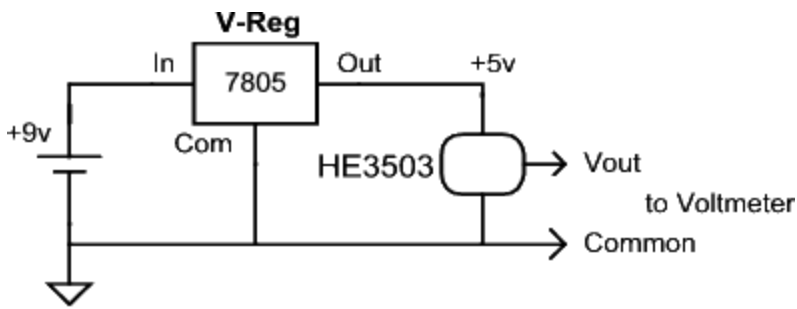

With no magnet near the Hall device, measure and note the output voltage reading. Call this V_0 . It should be about 2.50Vdc.

Now, with a magnet near the Hall device, you will see the output voltage change. If it is a South pole, the voltage will increase. If it is a North pole, the voltage will decrease. Call this voltage reading V_1 .

We will say that the sensitivity of the Hall device is 2.50mV/G as found on their data-sheet. Call this k .

Therefore, the Magnetic Flux Density you are measuring from that magnet can be calculated as:

$$B = 1000 \cdot (V_0 - V_1) / k, \text{ in Gauss.}$$

Please note that with a calibrated Hall device, you would be given actual data measurements for the V_0 value and for the k value.

For example, suppose you measured 2.48Vdc for V_0 and 1.32Vdc for V_1 . Then $B = 1000 \cdot (2.48 - 1.32) / 2.50 = 464 \text{ Gauss}$, North pole (because it is positive).

For another example, suppose you now measured 4.56Vdc for V_1 with the same Hall device. Then $B = 1000 \cdot (2.48 - 4.56) / 2.50 = -832 \text{ Gauss}$, South pole (because it is negative).

See how easy that is? You can make your own plot using Excel so you don't have to calculate all the time. If you're taking measurements, just write down the output voltage and do the calculations later. You can simply use it to tell you if you have a North if the output voltage decreased from V_0 , or a South pole if the voltage increases from V_0 .

Here are some photos of this simple, inexpensive Gaussmeter.

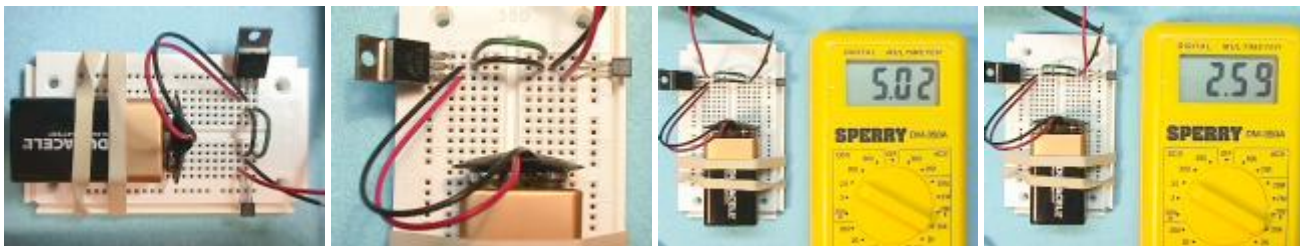
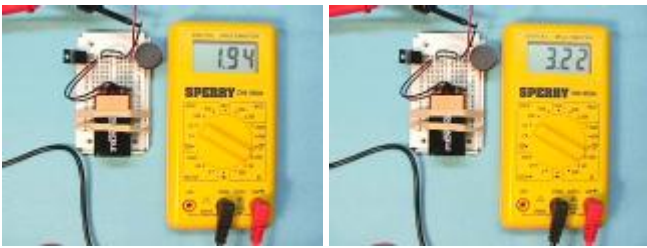

Photo 1 is an overall photo of the breadboard circuit. Let's look at the close-up in photo 2. The 9V battery is at the bottom, the 7805 voltage regulator is on the top left, the Hall device is on the top right. The red lead from the 9V battery goes to pin 1 of the 7805. The black lead from the battery goes to pin 2 of the 7805. The output of the 7805 (pin 3) is connected by a green wire to pin 1 of the Hall device. Pin 2 of the 7805 is connected by a black wire to pin 2 of the Hall device. Please note that the marking on the Hall device (giving its part number) is facing the camera. The voltmeter common (black) is connected to pin 2 of the Hall device. The voltmeter input (red) is connected to pin 3 of the Hall device. (I got the voltmeter from a [Home Depot](#) store near here for about \$20.) That's all there is! Great, or what?!

Photo 3 shows the voltage at pin 3 of the voltage regulator. Ideally it is 5.00 volts, but we measured 5.02, which is close enough.

Photo 4 shows the output of the Hall device when no magnet is nearby. Ideally it is 2.50 volts, but we measured 2.59. This would be our V_0 as noted above. The Hall device I have here is an Allegro UGN3503U, with a sensitivity of about 1.3 mV/G.



With a disk magnet sitting on top of the Hall device, the voltmeter is measuring 1.94 volts. This means that the Gauss measurement is $1000 \cdot (2.59 - 1.94) / 1.3 = 500$ Gauss, North pole.

With the disk magnet flipped over, the voltmeter is measuring 3.22 volts. This means that the Gauss measurement is $1000 \cdot (2.59 - 3.22) / 1.3 = -485$ Gauss, South pole. You will notice that the placement of the magnet with respect to the Hall device is very critical, since the measurement varies across the surface of the magnet (as it is supposed to, being strongest at the edge, not the middle!).



With a NIB magnet sitting on top of the Hall device, the voltmeter is measuring 0.99 volts. This means that the Gauss measurement is $1000 \cdot (2.59 - 0.99) / 1.3 = 1231$ Gauss, North pole.

With the NIB magnet flipped over, the voltmeter is measuring 4.30 volts. This means that the Gauss measurement is $1000 \cdot (2.59 - 4.30) / 1.3 = -1315$ Gauss, South pole.

Now, the absolute value is not going to be correct since I don't have a calibration chart with this device, but the relative measurement will be as accurate as the Hall device, typically within 10 Gauss for the A3515 and the A3516 devices from Allegro. From the measurements, I know that the NIB is $1231 / 500 = 2.46$ times stronger than the disk magnet! So, this gaussmeter will work well for measuring the variation of a magnet's flux density with respect to temperature very well!



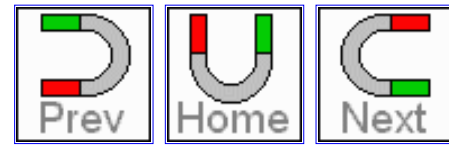

Experiments with magnetic levitation

Home-Built Magnetic Levitator EXPT



With this assembly, I was able to suspend a magnet about 1" below an electromagnet. Here are the details on the circuit design.

This project requires you to have some familiarity with building and testing electronic circuits. A great way to start is to obtain an "Engineer's Mini-Notebook" book from Radio Shack, by Forrest M. Mims III, on building circuits. He has a lot of different booklets out for all sorts of projects. They go into a fair amount of detail so you'll start to learn how the circuits work, how to put things together, etc. Or, if you have a friend, teacher, or know someone who is an electrical engineer, electrical technician, sound technician, etc, ask him/her for some guidance, and I'm certain they would be glad to help lend a hand.

Suppose we would like to design a device that would allow us to suspend an object a fixed distance below an electromagnet as shown here. How can we do this? First, let's review the theory behind a controller that we will need.

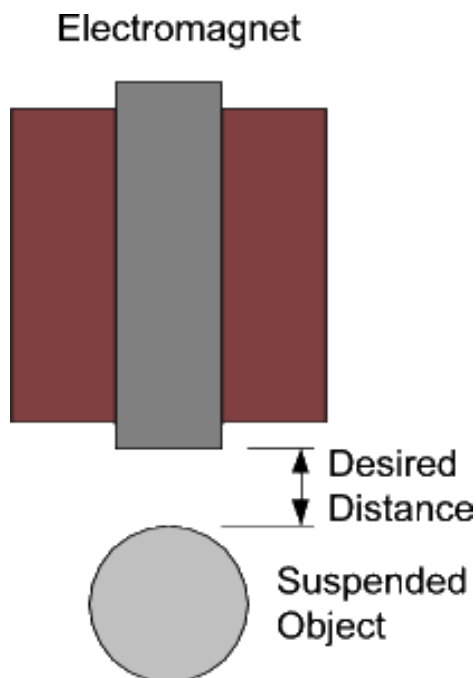

Feedback Regulation

If the electromagnet used to suspend the object were simply operated with a fixed amount of current, this would not be able to maintain any kind of control over the position of the object. If the object were too close to the electromagnet, it would be pulled right up to it. If it were too far away from the electromagnet, it would fall to the floor. There would be no way to adjust for or compensate for the slight variations that take place in order to maintain the object at a fixed distance from the electromagnet. This would be called an "open loop" control system.

We need the ability to quickly control the current to the electromagnet depending upon the position of the object to the electromagnet. This will allow us to be able to suspend the object under the electromagnet at a fixed distance. This kind of improvement is only possible when the control for the electromagnet can monitor the position of the object and regulate the current to the electromagnet. For example, when the object gets too close to the electromagnet, the current in the electromagnet will decrease, allowing the object to begin to fall away due to gravity. When the object gets too far away from the electromagnet, the current in the electromagnet will increase, pulling the object closer to the electromagnet. Basically, it will do whatever is needed with the current in the electromagnet in order to keep the object at a fixed distance below the electromagnet. This is called a "closed loop" or "feedback" control system.

The heart of the closed loop system is the regulator or feedback controller. This can be simplified to a set of inputs and outputs connected as shown here.

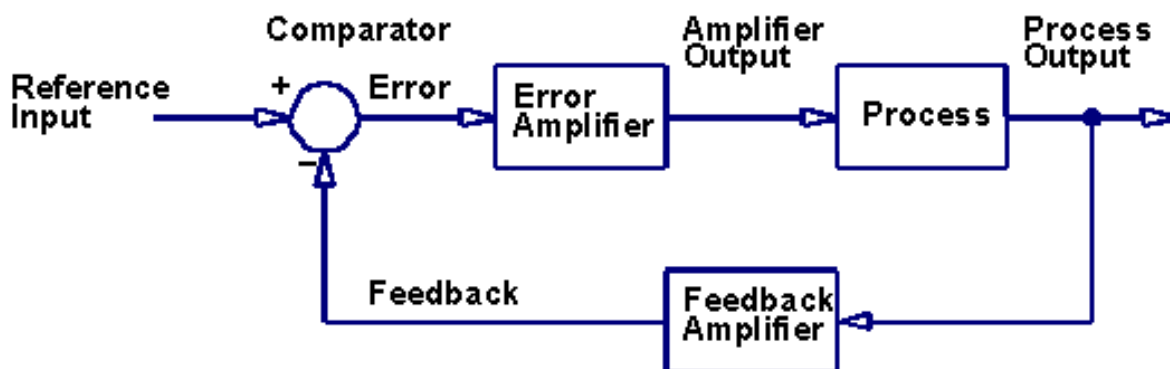

The goal of this system is to make the process output equal to the reference input at all times, even if the process is perturbed by outside forces. We will describe each of the components of this system and relate them to a familiar control system: the speed control operation of a car by a driver.

- 1). The input signal is called a Reference Input or command. In our example, this would be the speed limit sign stating that the limit is 55MPH.
- 2). The Feedback signal is a representation of the process output of the system, and is used for comparison to the reference. Most often the feedback signal goes through a converter or amplifier so its signal can be directly compared to the reference input signal. In our example, the feedback signal is obtained from the speedometer stating that the car is traveling at 45MPH.
- 3). The Comparator simply subtracts the feedback signal from the input signal in order to create an Error or difference signal. A positive error signal will cause the process output to increase. Similarly, a negative error signal will cause the process output to decrease. In our example, the comparator is a mental operation where the driver determines that the speed limit is 10MPH over his present speed. Since the error signal is positive, the driver will press harder on the gas pedal.
- 4). The Error Amplifier converts the error signal to something the process can use. The type and gain of this amplifier directly affects how quickly and how well the output of the process will follow the reference input. In our example, the amplifier is the engine of the car. The position of the gas pedal controls the amount of fuel going to the carburetor, which controls the torque produced by the engine.
- 5). The Process or load takes the output from the amplifier and converts it to the Process Output which is the parameter being monitored and controlled. Even if the output from the error amplifier does not change, the process can vary over time which will affect the output of the system. This is where the beauty of a feedback control system shines. Since the feedback signal continually monitors the process output, and is continually being compared to the reference input, the

system can continually adjust for variations in the process.

In our example, increasing the torque out of the engine causes the speed of the car to increase. When 55MPH is achieved (process output equals the reference input), the driver lets up on the gas pedal which reduces the engine torque in order to maintain this speed. However, as he begins to climb a hill, the car will slow down even though the engine's torque (amplifier output) has not changed. The speedometer (feedback) will indicate the reduction in car speed, the comparator (driver) will calculate a new error signal and will increase the amount of fuel going to the engine. The engine (error amplifier) will produce more torque causing the speed of the car to again increase. As the crest of the hill is reached, the car will begin to speed up and exceed the speed limit. The driver will again adjust by letting up on the gas pedal. However, if there is a malfunction in the control system such that the comparator (driver) does not respond to the over-speed condition, flashing red lights accompanied by a loud siren will appear in the rear view mirror. This will command a new reference input of 0MPH causing the control system to bring the car to a stop!

This example can be summarized as shown here.

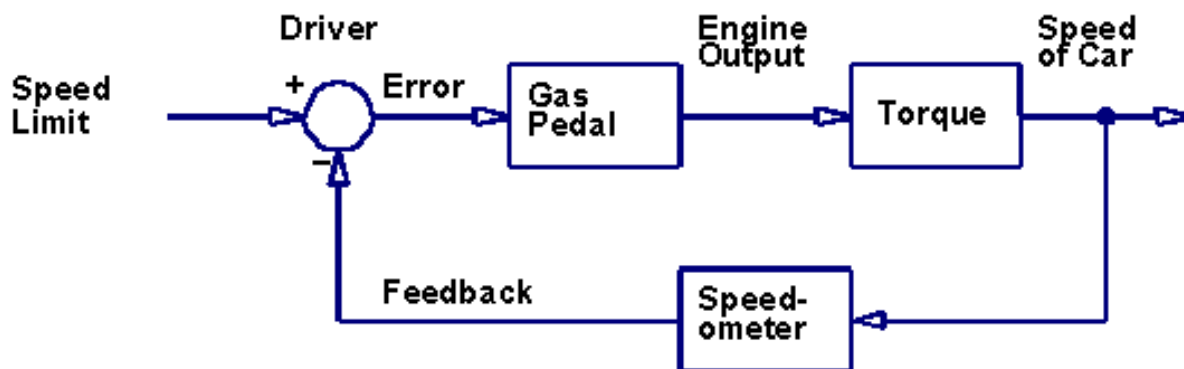

Basic Methods

For our project, we need to do something similar. The feedback system for this is going to be basically the same.

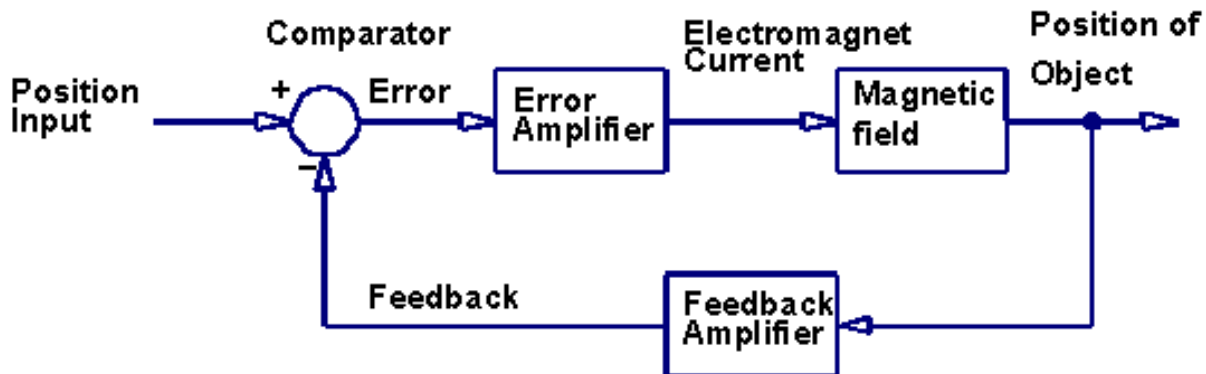

The Reference Input is now the Position Input or command.

The Comparator compares the Position Input to the position Feedback.

The Error Amplifier amplifies the difference between the Position Input and the Feedback.

The Amplifier Output is the current going to the electromagnet.

The Process being controlled is the strength of the electromagnetic field.

The Process Output is the position of the suspended object with respect to the electromagnet.

The Feedback Amplifier is some kind of device or system used to detect how far away the object is from the

electromagnet.

Now, all we have to do is design the circuitry needed for perform each function within each box above. How do we do this? First, we need to decide what we are going to suspend and how we are going to detect the distance of the object from the electromagnet. There are several methods open to us. Let's look at a few of them and select one.

Here we show a steel ball as the suspended object, with an energized electromagnet providing the force to counterbalance gravity.

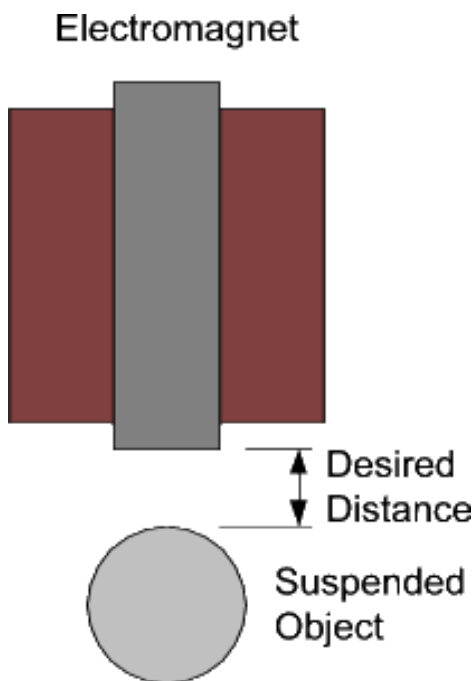

Now, how do we detect the distance between the electromagnet and the ball? Looking at the diagrams, we can use an infrared light emitter and detector set up so that the ball will block only a certain portion of the light. If the infrared is totally blocked, the ball is too close. If the infrared isn't blocked at all, the ball is too far away. If just half of the infrared is blocked, the position of the ball is just right.

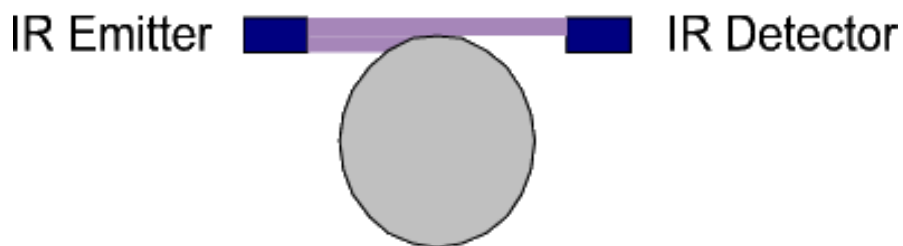
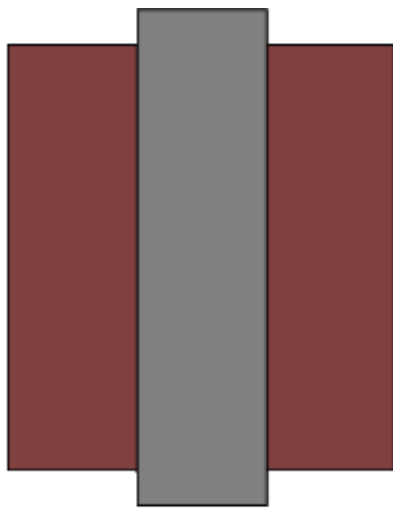

Another method would be to again use an infrared light emitter and detector, but aimed to reflect off of the surface of the ball. Again, if no infrared bounces back, the ball is too far away. If too much infrared bounces back, it is too close. If there is just the right amount of infrared, the position of the ball is just right.

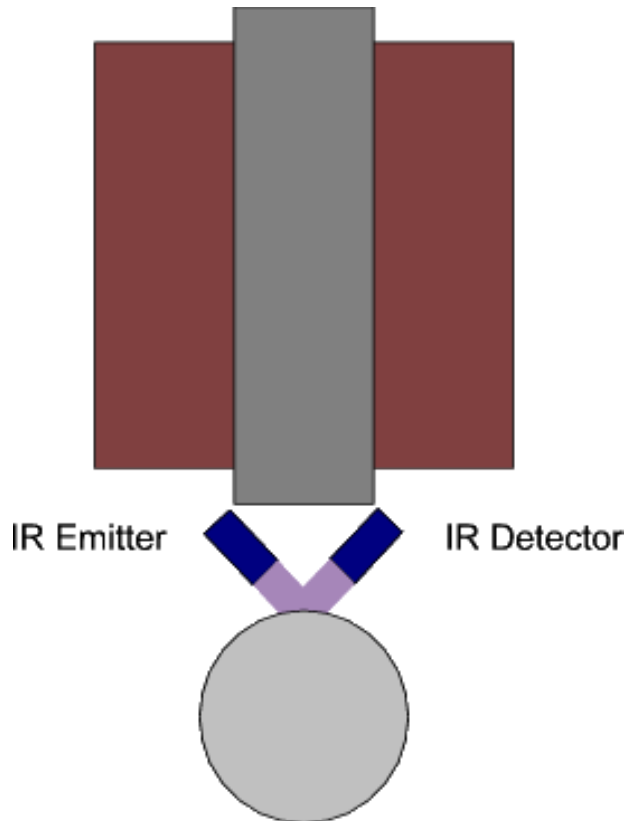

There is also available an ultrasonic emitter and detector, used in some cameras to do the automatic focusing. If this were placed under the ball, the strength of the signal would tell us how far away the ball is located. The circuit would be set to command a specific distance. I don't know how fast these devices can respond to changes in distance.

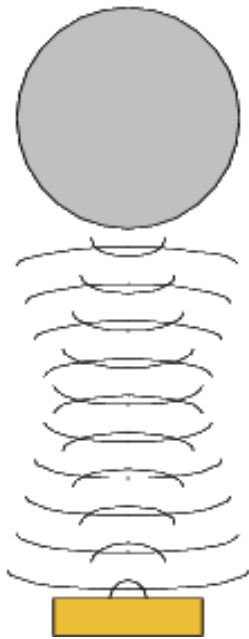
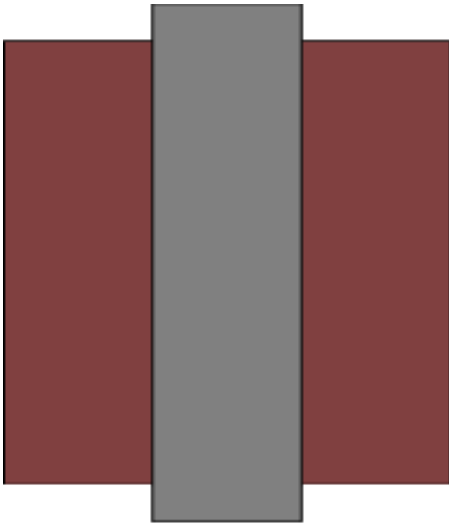

Instead of using a steel ball, what if we were to use a permanent magnet for the suspended object? What options are open for us for doing the detection? One thing we may want to do with the magnet is to stick a small steel bolt to it in order to make it a little more stable so it wouldn't flip over easily.

Levitor Experiment

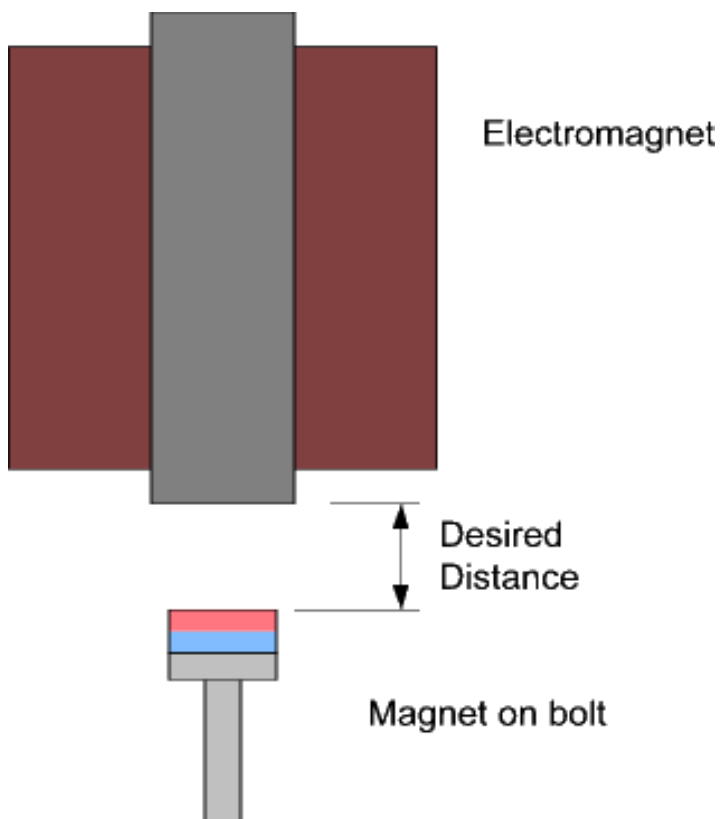

Again, we could use any one of the methods already mentioned with the steel ball. They are shown here.

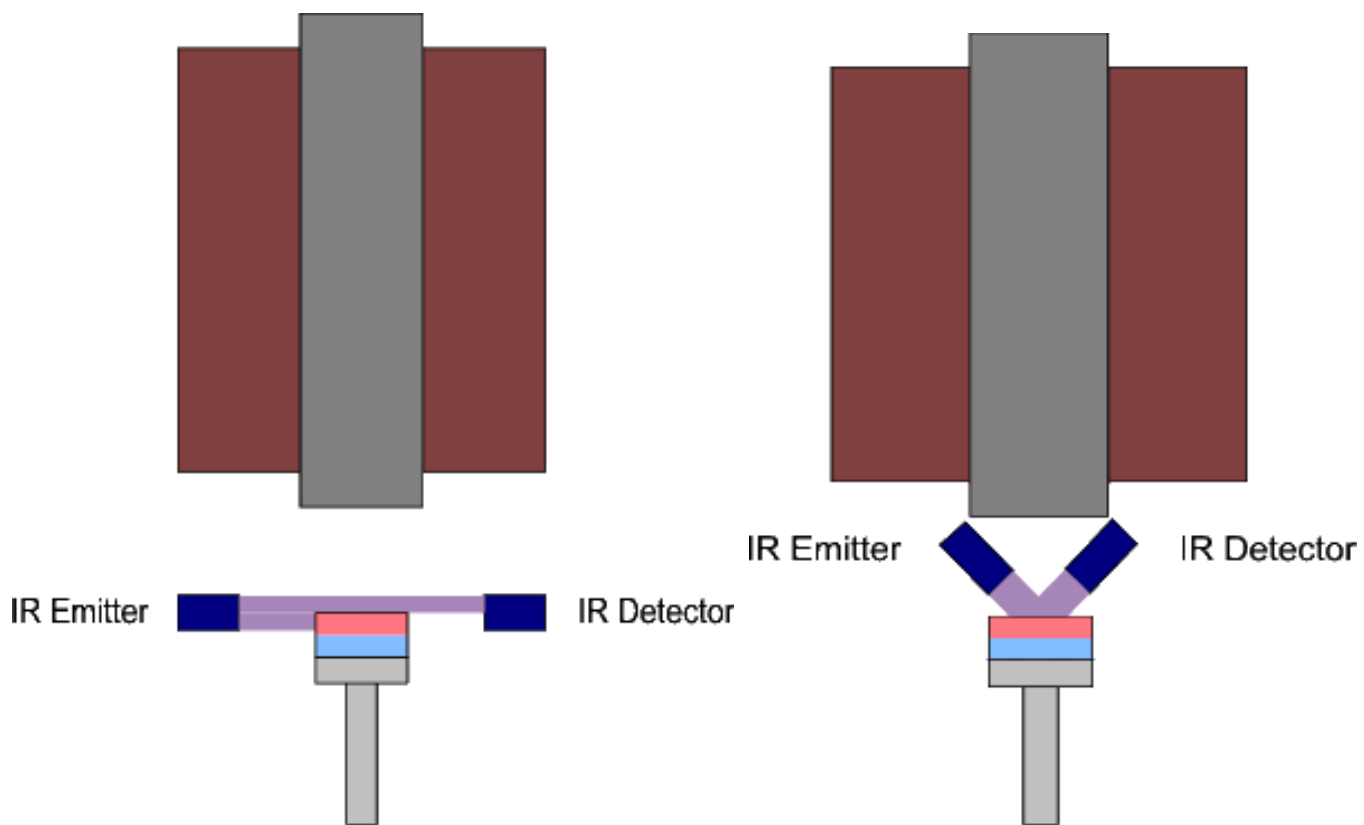

Levitor Experiment

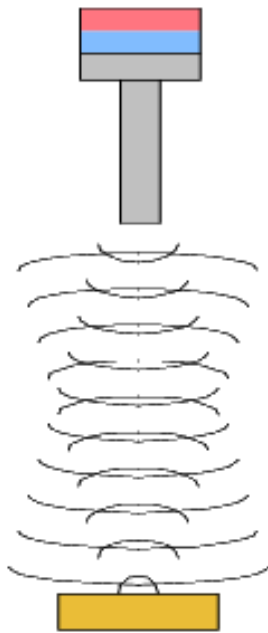
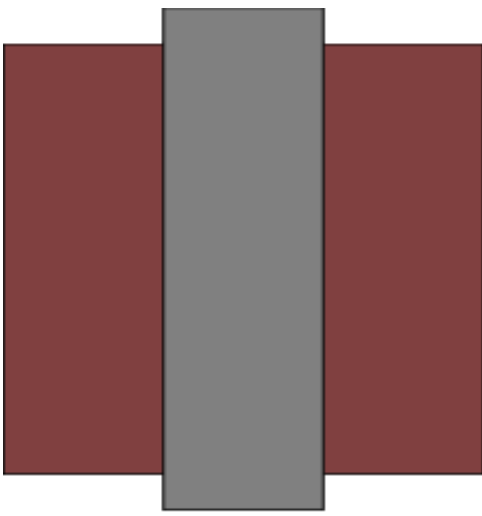

Ultrasonic
emitter and
detector

However, we could also do a couple of other things. If the object could contain two magnets, one could be used with the electromagnet for the suspension, and the other could be placed at the bottom of the object, close to where we would place a hall effect device. This device could be used to indicate how close the bottom magnet is, so we would know how far away the object is from the electromagnet. The object would have to be a stiff item, not spongy.

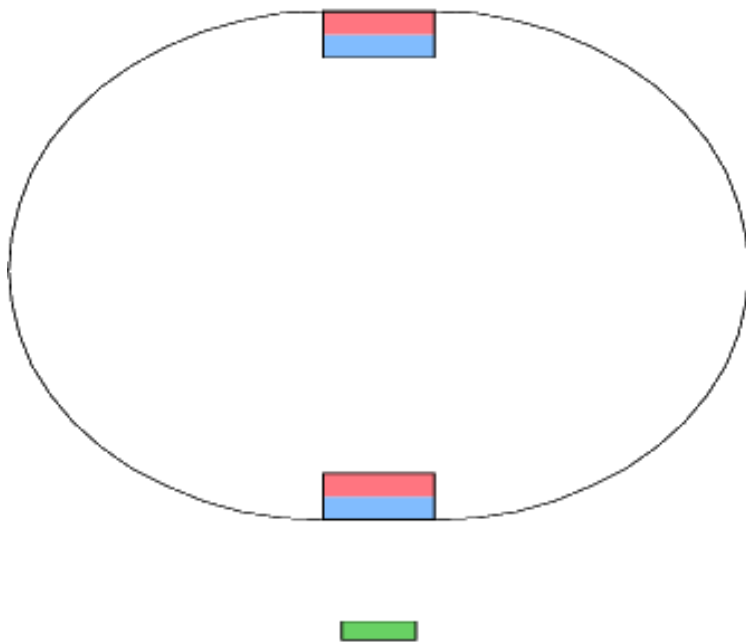
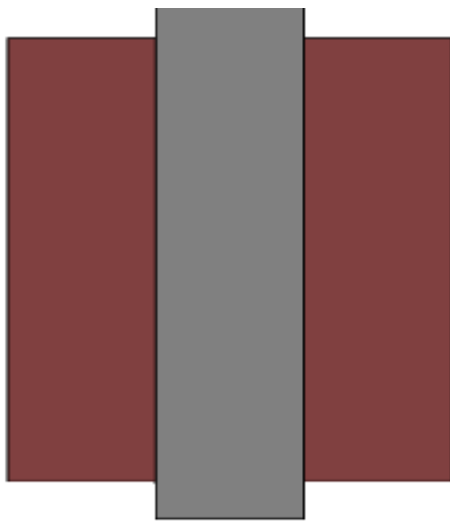

Another method would be to use two hall effect devices, one mounted onto each end of the electromagnet. When no permanent magnet is near, no matter how much current is in the electromagnet, the two hall effect devices' signals would cancel each other out. When a magnet gets closer to one, then the difference between the two signals starts to increase. So, it is this difference in signals that we could monitor and control. (By the way, this idea was patented in US patent number 4,910,633. Because of this, you would be infringing on the patent holder's rights to produce and sell something like this. However, there is no problem making something like it for your own use, you just can not sell it.)

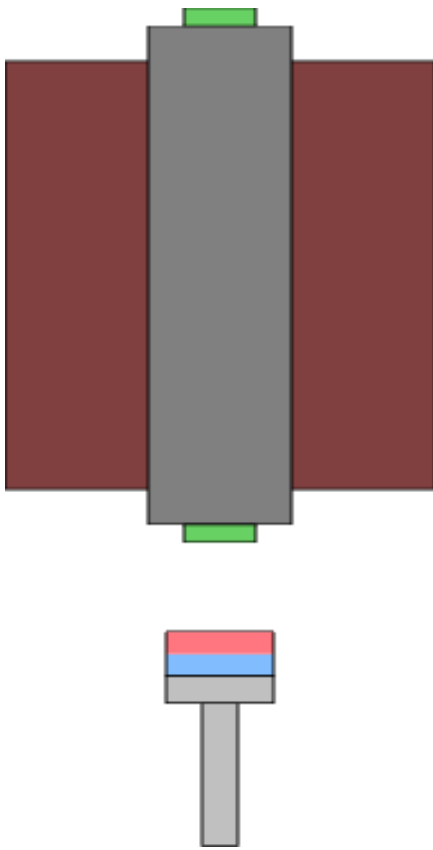

Let's do that. We'll use two, linear hall effect devices to monitor the magnetic field at each end of the electromagnet. When the permanent magnet gets too close to one, their difference signal will increase. When the permanent magnet gets too far away, their difference signal will decrease to zero.

The Control Circuit

The feedback amplifier will need to take two, linear hall effect device signals and subtract one from the other to give us a difference signal. This difference signal will be compared to our position reference signal, and the error will be used to control the amount of current in the electromagnet. The first part of the circuitry is shown here.

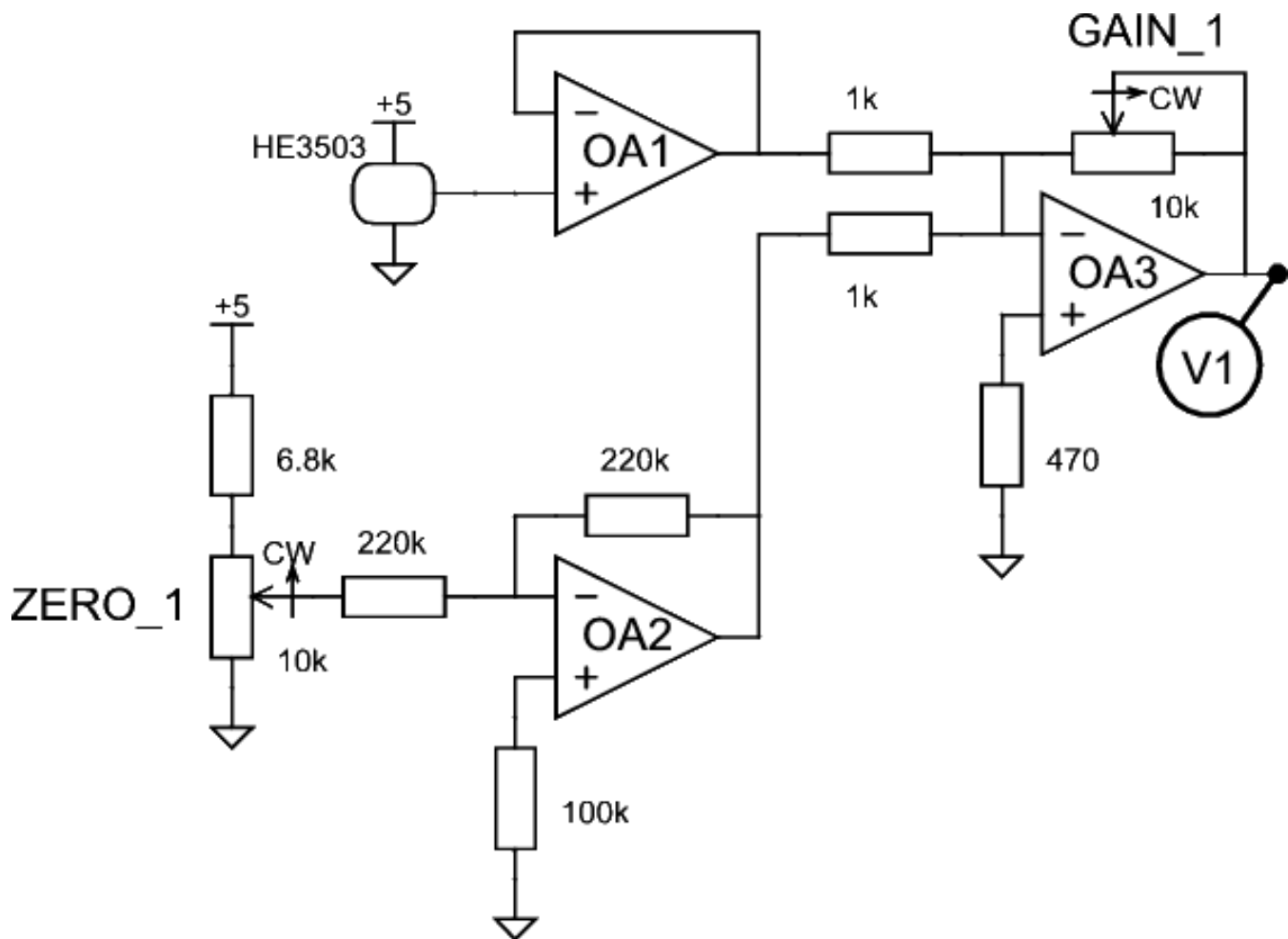

This is the heart of the feedback circuitry. The linear hall effect device, HE3503, is fed from a +5V source. Now, when there is no magnetic field near the hall effect device, its output voltage is about 2.5V. When a North pole approaches the marked surface of the device, the voltage drops to about 1V at 1000 Gauss. When a South pole approaches it, the voltage rises to about 4V at 1000 Gauss. What we want to do is make the output at V1 equal to zero when there is no magnetic field, +9V at maximum Gauss North pole, and -9V at maximum Gauss South pole. To do this, we will use LM324 op-amp ICs that contain four op-amps (TL084 also works well). First, we take the output of the hall effect device directly into an op-amp, OA1, that acts like a follower (its output is the same as the input, but with lower impedance). It then feeds a 1k resistor into another op-amp, OA3, that acts like an amplifier with an adjustable gain between 0 and 10 times. In order to get rid of the 2.5V offset when no magnetic field is present, we have the ZERO_1 pot that feeds from the same +5V supply, and is inverted by OA2.

To set this up, we start with no magnetic field near the hall effect device. Set the GAIN_1 fully clockwise for maximum gain, and look at the voltage test point V1. Adjust ZERO_1 until the voltage at V1 is zero. Now, place the hall effect device onto the electromagnet. When full power is applied to the electromagnet, adjust GAIN_1 to get +9V out at V1.

Next, we build another circuit identical to this one, and label the pots ZERO_2 and GAIN_2. Set them up the same way. Its output is at test point V2.

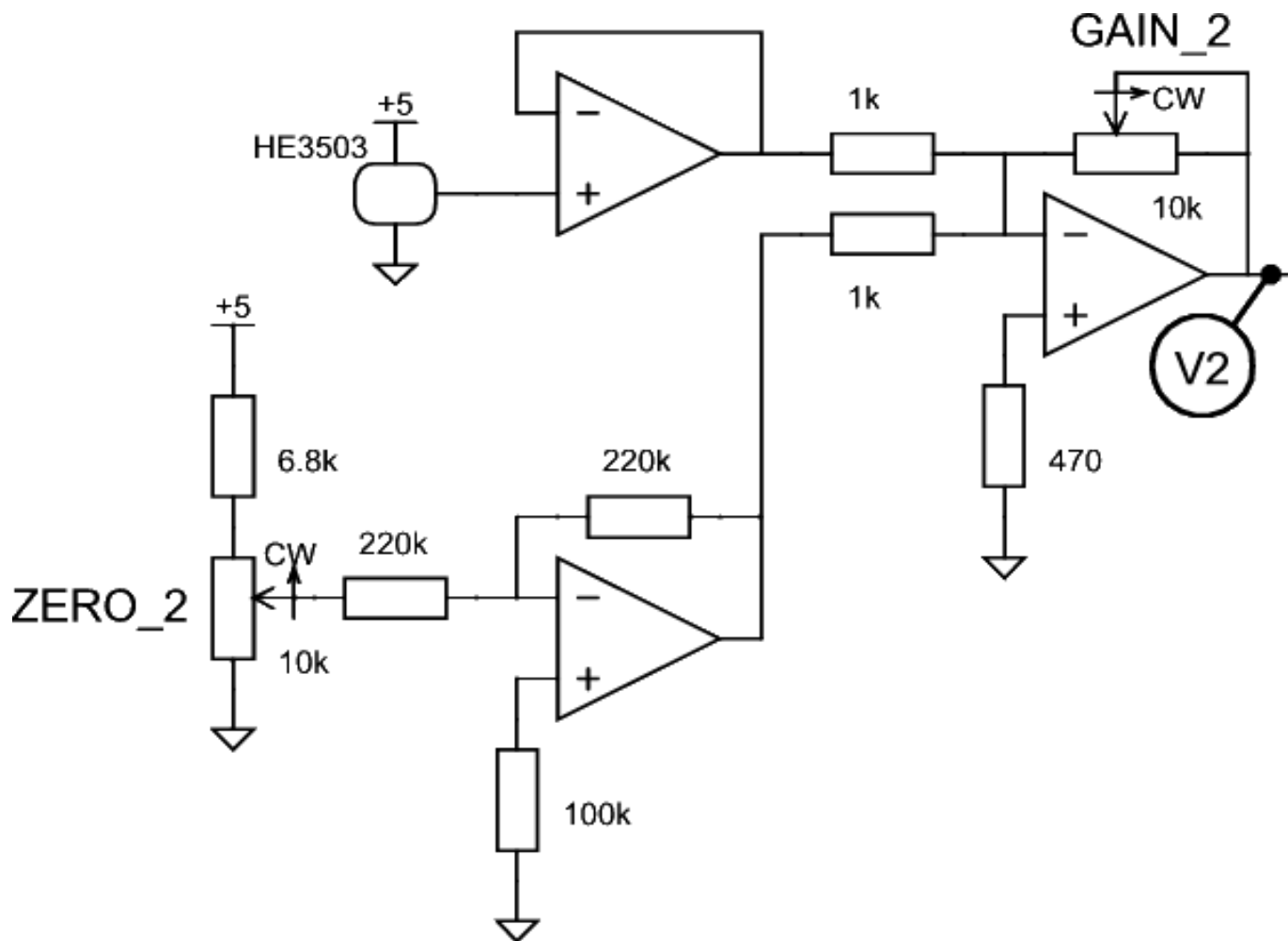

The way we attach these hall effect devices to the steel core of the electromagnet will have an affect on how the feedback will work. We want the top surfaces of the hall effect devices on the face of the steel core, for both the one on the top and the one on the bottom of the electromagnet core. This is diagramed below when we talk about construction.

The reason for this is to obtain two opposite polarity signals. The gain adjustment pots will be tweaked to make sure they cancel each other out when no magnet is near either one of them. This way, V1 will be the negative of V2, and their sum, V3, will be zero volts. When a magnet approaches one of the ends of the electromagnet, causing an imbalance in their output signals, the sum of V1 and V2 will no longer cancel and V3 will no longer be zero but could be positive or negative, depending on the polarity of the magnet.

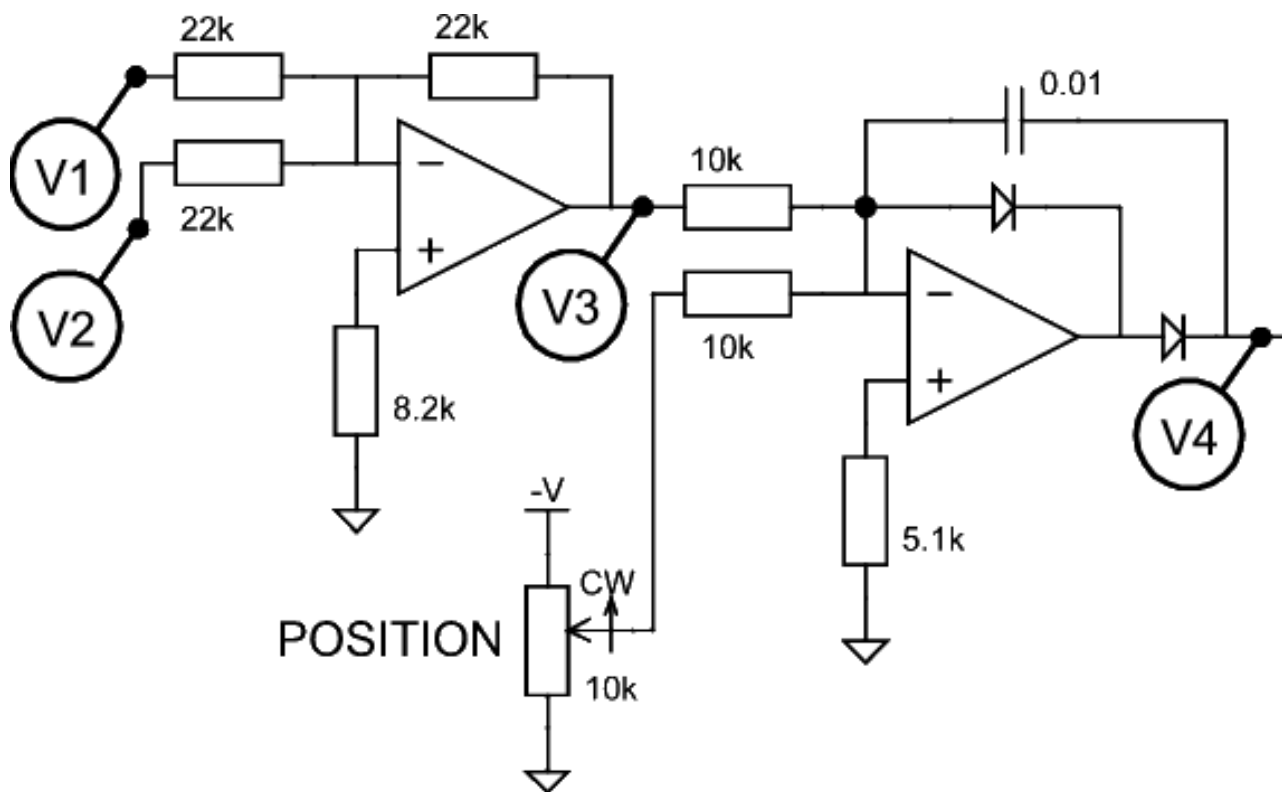

The output V3 is the position feedback signal. We now need a position reference signal. This comes from the pot labeled POSITION. The next op-amp compares V3 to the POSITION pot voltage level, and creates an error signal at test point V4. If V3 is closer to zero than the POSITION voltage level (please note that the POSITION voltage level is a negative voltage) the output V4 will integrate to about +10V. If the absolute value of V3 is greater than the POSITION voltage level, then the output V4 will integrate to 0V and stay there. The diodes around that op amp prevent V4 from going negative. This completes the reference input, feedback amplifier, feedback signal, comparator and error signal portions of the circuit.

Power Circuit

Now on to the error amplifier, process and the process output sections of the control.

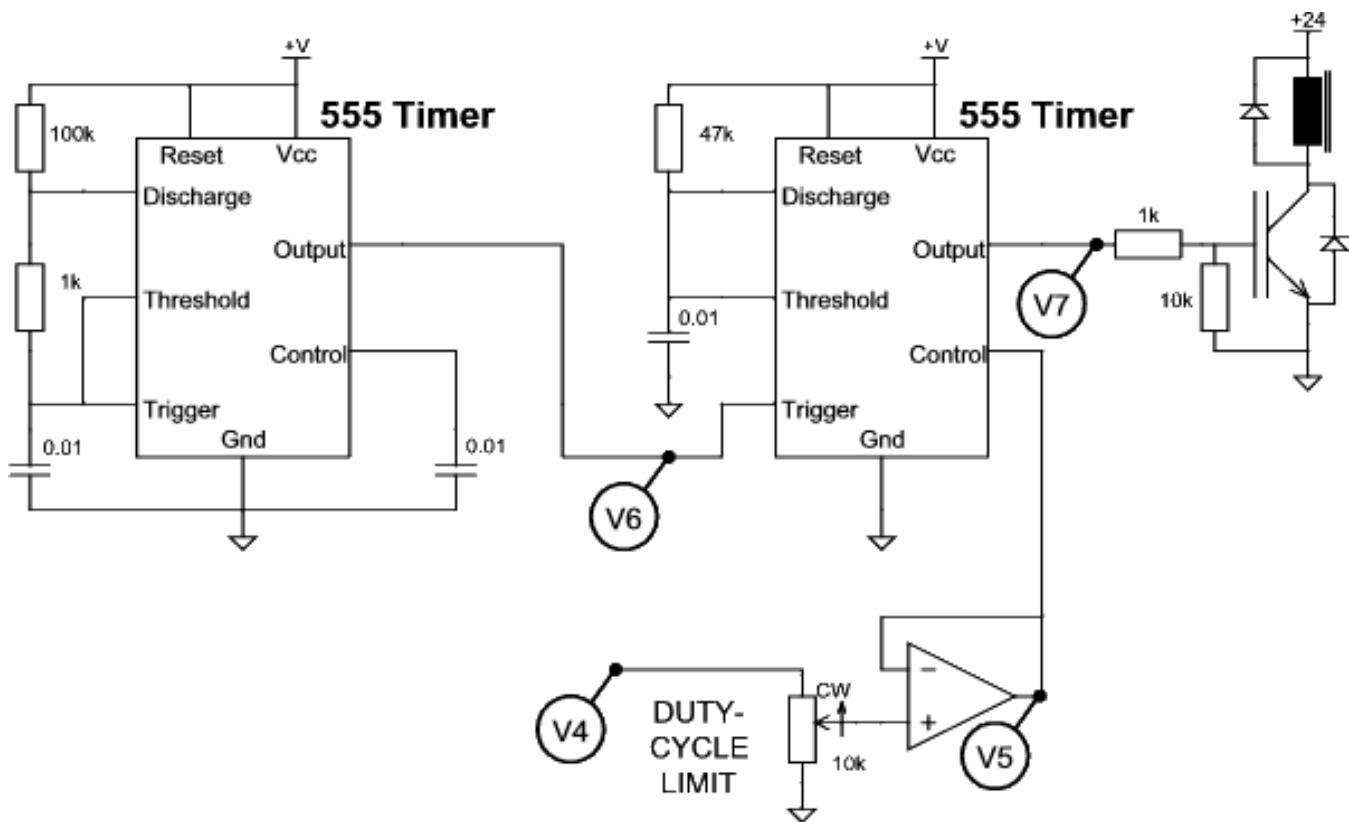

This circuitry takes the error signal, V4 (from the op-amp in the previous circuit above), and uses it to control the current in the electromagnet, directly controlling the strength of the electromagnet's magnetic field. The 555 timer on the left is a free-running oscillator that operates around 1kHz at V6. Its duty cycle is about 1%. The 555 timer on the right takes that signal and creates a pulse-width-modulated signal, using the oscillator as the carrier frequency, and with a duty cycle proportional to the voltage seen at V5. Please note that the DUTY-CYCLE LIMIT pot sets the maximum duty cycle allowed out at V7. When V5 gets close to the +V of 12 volts, the PWM becomes erratic, so this pot prevents this from happening. This also limits the maximum current that the electromagnet will be allowed to carry by limiting the voltage to the electromagnet.

V7 feeds the gate to an IGBT (insulated gate bipolar transistor) causing it to turn on when V7 is high, and turn off when V7 is zero. The pulse-width-modulation simply allows the IGBT to be on for a certain portion of its 1kHz cycle, and off for the rest. The average of its on time to its cycle time will be proportional to the average current in the electromagnet. This allows for quick response. The only thing the IGBT can do is turn on or off, it can not reverse the current through the electromagnet if the permanent magnet gets too close and needs to be pushed away. We are counting on gravity to pull the permanent away from the electromagnet when the IGBT is off.

The electromagnet is powered by its own 24V source. It will be handling a fair amount of current. There is a fast recovery diode around the electromagnet to allow the current that was flowing through it to "freewheel" around. If it weren't there, the electromagnet would create a very high voltage whenever the IGBT switched off, damaging the IGBT. The diode around the IGBT isn't needed for this circuit, but is part of the IGBT package.

Construction

For the op-amps, use LM324 or TL084 type ICs. There are four op-amps within each IC package. For the unused op-amp sections, simply connect them as shown below.

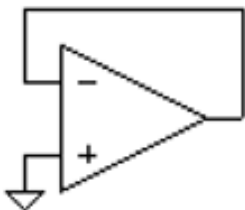

For the LM555 timers, I suggest using a single LM556 IC package that contains two timers. For both the timers and the op-amps, follow the signal inputs and names as shown on the schematics. The diodes used with the op-amps are 1N4148 signal diodes. The pots are all 10k, 10 turn pots, making them easy to adjust. The resistors are 1/8 watt parts. They can be purchased separately, or you can get a package with a variety of resistors, which I'm sure you'll want to use sometime in the future for other projects. You may need to do some tweaking with this project as well. A parts list of the items from Radio Shack is below.

The power supply needed for this will require +5V, +12V and -12V outputs, all at about 150mA load. I would suggest that you obtain a used computer power supply for this. That should work real well. Or, you can build your own. In the schematic, +V means +12V, and -V means -12V. In addition, we will need a 0 to +24V supply at 10 Amps for the electromagnet. It's good to start with a variac, with a full-wave diode bridge, feeding an electrolytic capacitor. This way, you can have absolute control of the voltage to the electromagnet while you check out the circuit and controls. The diodes used for the bridge were Eupec P/N DD46S12K parts, two diodes per module. The capacitor was rated for 4700uF at 400Vdc.

The three parts that are more difficult are the electromagnet (we can make our own), the IGBT, and the freewheeling diode for the electromagnet.

Let's start with the electromagnet. First, you will need a bobbin (the plastic form that holds the wire) and about 300 feet of #26 AWG magnet wire. (It's called magnet wire because it is used for making electromagnets.) To obtain this, you can purchase 4 packets of magnet wire from Radio Shack. All you will use is the #26 gauge wire, but don't throw the rest away! Start with one of the bobbins with the #26 gauge wire on it (the middle size diameter wire - the others are either thinner or thicker). Don't remove the wire from the first bobbin. It is nicely wound, and we'll start with that. Carefully remove the insulation from about 1/2" on the ends of the wire. Now, take the other bobbins of #26 gauge wire, and again remove the insulation from their ends. Slide a 1" piece of heat-shrink insulation over the end of the first bobbin's wire end, and then solder that end of wire to the wire end from bobbin number 2. It may be good to twist the bare ends of wire together before soldering, to make sure there is a good mechanical connection. After the solder cools, slide the heat shrink tubing over the soldered joint and shrink it on to insulate the connection. Now, carefully wind the wire from bobbin number 2 onto the first bobbin. When you get to the end of bobbin number 2, you will connect it to the wire from bobbin number 3 and so on until you have all 300 feet (4 * 75 feet) of #26 gauge wire onto bobbin 1.

The iron or steel core was taken from an 8" long bolt, 3/4-13 (diameter in inches and the number of threads per inch). I cut off the hex head of the bolt and cut off the threaded portion of the shaft so that I was left with a smooth, steel cylinder about 5" long and 3/4" in diameter. It should be made shorter so that you would have about 1/4" sticking out of each end of the electromagnet bobbin.

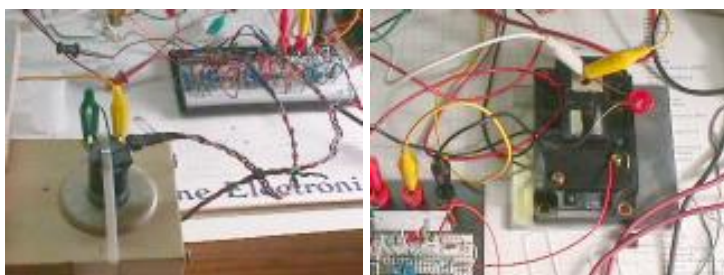

Fasten the hall effect devices to the steel core. Again, have the marked end of each face the core. (They could also both face the other way, but have them do the same thing. Don't have one face the core and the other face away from the core. Otherwise, their signals would not subtract. Place the hall effect devices as close to the middle of the 3/4" faces of the core as possible. We want them to see the same kind of flux. To fasten them down, you could use superglue. I used double-sided tape and a ty-rap to hold them in place. This way, I could move things around if needed. Also, put a piece of foam rubber over the bottom hall effect to protect it. When the magnet gets too close to the core, it will be quickly attracted to the core and could damage the hall effect device if it weren't protected with the piece of foam.

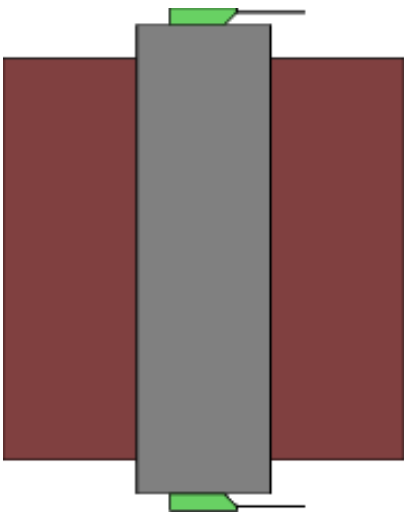

To hold the electromagnet, I cut a hole in a piece of wood, the same size as the winding, and then sliced the wood so I could open it up, place the electromagnet into the hole, and refasten it (kind of like a clamp). The bobbin end prevents the electromagnet from falling out. The steel core was held in place with tape and a ty-rap (plastic cable fastener).

The IGBT I used was rated for 300A and 1200V (way overkill, but was available). It is a Powerex P/N CM300HA-24H. I then used a Semikron SKR60F17 diode for the freewheeling diode around the choke. Another possibility would be to use a Powerex CM200E3Y-12H for the IGBT and it includes a fast recovery diode for the freewheeling diode. Mount the IGBT module and diode to an aluminum plate or heat-sink, and even blow it with a fan in order to keep it cool. The electromagnet, especially, will need to be kept cool. A small fan helps a lot.

Testing

After the items are assembled, you will want to begin to check out each section. Remove the 1k resistor at V7, remove the 10k resistor at V3, and connect the end of the DUTY-CYCLE LIMIT pot that was on V4 to +12V.

Let's start with the electromagnet. Start with the electromagnet connected directly across the 24V supply capacitor. Begin by bringing up the DC voltage on the variac, watching the current flowing in the electromagnet. At 10Vdc, you should have about 1 amp flowing. Make sure the winding doesn't get too hot to touch. All OK? Good!

Now, let's set up the hall effect amplifiers. With the power to the electromagnet off, set the ZERO_1 pot fully CCW and the GAIN_1 pot fully CCW. Look at V1. It should be about 2.5V as noted before. Now, begin to turn the ZERO_1 pot CW while monitoring V1. Keep turning until V1 becomes 0.0V (zero volts). As you increase the voltage to the electromagnet, continue to monitor V1. It should stay very close to 0.0V. Now, with the voltage on the electromagnet at about 10V, turn the GAIN_1 pot CW until V1 is at 8.0V.

Repeat this for the other hall effect amplifier while monitoring V2 and adjusting ZERO_2 and GAIN_2. Now, check V3. It should be close to 0.0V when the voltage to the electromagnet is off, and when it is at 10V. If not, adjust GAIN_2 so that it stays close to 0.0V while the voltage on the electromagnet is varied from off to 10V.

Now, check that V6 is creating a 1kHz series of narrow pulses. As you vary the DUTY-CYCLE LIMIT, you should see the pulses at V7 change width. As the voltage increases at V5, the widths increase at V7. You will also find out the maximum voltage that V5 can go to without causing strange jumps in the widths seen at V7. Make note of that. We will call this its max setting.

If this is all working OK, then replace the 1k resistor at V7. The positive voltage pulses will turn on the IGBT, causing current to flow through the electromagnet. With this connected, you should now be able to control the voltage across and the current through the electromagnet simply by adjusting the DUTY-CYCLE LIMIT pot, that control V5. Set it fully CCW. Turn up the variac to 10V. Make sure that with the pot fully CCW, the voltage across the electromagnet is zero. With the pot turned to its max setting, the voltage across the electromagnet should be close to 9 or 10V.

Now, let's do some feedback checking. While checking V3, and with V5 at zero (DUTY-CYCLE LIMIT pot fully CCW), bring a magnet close to the end of the electromagnet. You should see V3 going positive, depending on the distance between the electromagnet and the magnet. If it goes negative instead, turn the magnet around. With the magnet about 1/4" away from the electromagnet, note what the voltage is at V3. I expect about 2 or 3 volts. Increase

V5 to get about 4 volts across the electromagnet, and again bring the magnet close to the end of the electromagnet while checking V3. It should react the same way. Turn the LIMIT pot down to make V5 zero. Set the POSITION pot to a little less than the negative of what you saw at V3 when the magnet was close to the electromagnet, like about -1.5V. Now, while checking V4, it should be close to 10 volts. When you bring the magnet close to the electromagnet, V4 should stay at 10 volts until V3 exceeds the voltage out of the POSITION pot, and then V4 will quickly go to zero. This is how the current in the electromagnet will be controlled. When the magnet is too close, V4 goes to zero turning off the electromagnet. When the magnet is too far away, V4 increases, turning on the electromagnet more. When the magnet is at the right spot, V4 will be wiggling around some voltage between zero and 10 volts.

Tweaking

It takes some time to make this work. It's important to be sure every part works properly. If it isn't right, you may need to swap the power connections to the electromagnet, and flip around the magnet. What else can go wrong? The value of the cap around the op-amp for V4 may need to be adjusted. I also found that the magnet would oscillate up and down at a frequency of about 2 or 3 cycles per second. This could be damped out by adding a little weight to the magnet (like the bolt), or the circuit may need some feed-forward by taking V3, going through a resistor and capacitor into the inverting input for the V4 op-amp. The values of R and C for the feed-forward circuit would be set equal to the frequency of the oscillations, so $f = 1/2 * 3.14 * R * C$. If the current in the electromagnet does not respond quickly enough to compensate for changes in the position of the magnet, perhaps a higher voltage is needed to help force the current. Or, a lower inductance coil is needed. Using 22 AWG wire would help with this. This would also reduce the resistance, causing higher current at the same voltage level. So, this is a lot of fun, but it does take dedication, some research, some serious time at the work bench, trying different things, redoing some things, but eventually you have good success.

Variations

Instead of using an IGBT as a power switch, it should be possible to use a power op-amp to control the current in the electromagnet. Here's a possible schematic for this. Now the key difference here is that this will cause the electromagnet to not only pull the magnet toward it if it is too far away, but it will also push the magnet away if it gets too close. Unlike the IGBT circuit that can only allow gravity to pull the magnet away. The circuits for the hall effect devices are identical to the previous circuits.

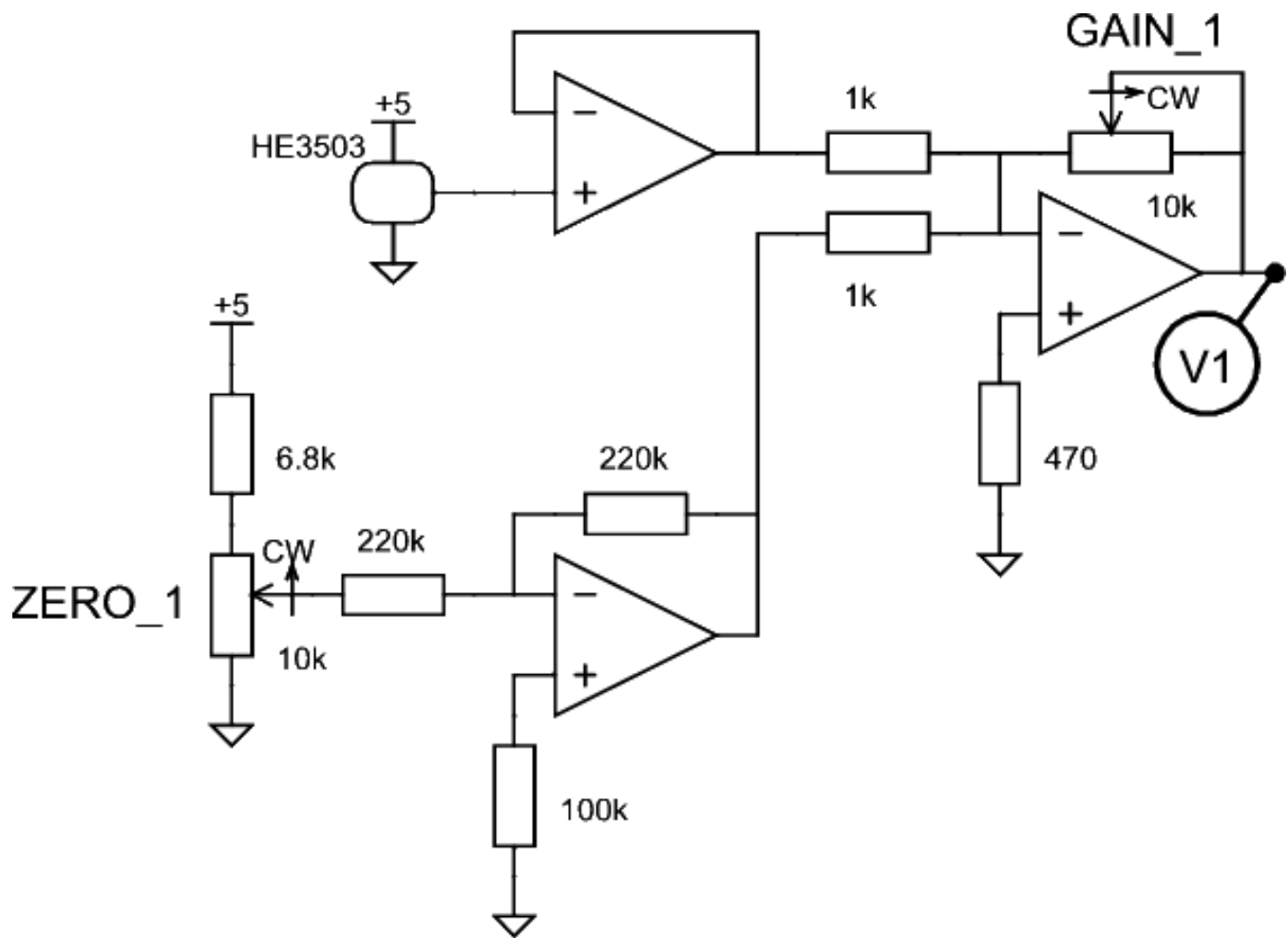

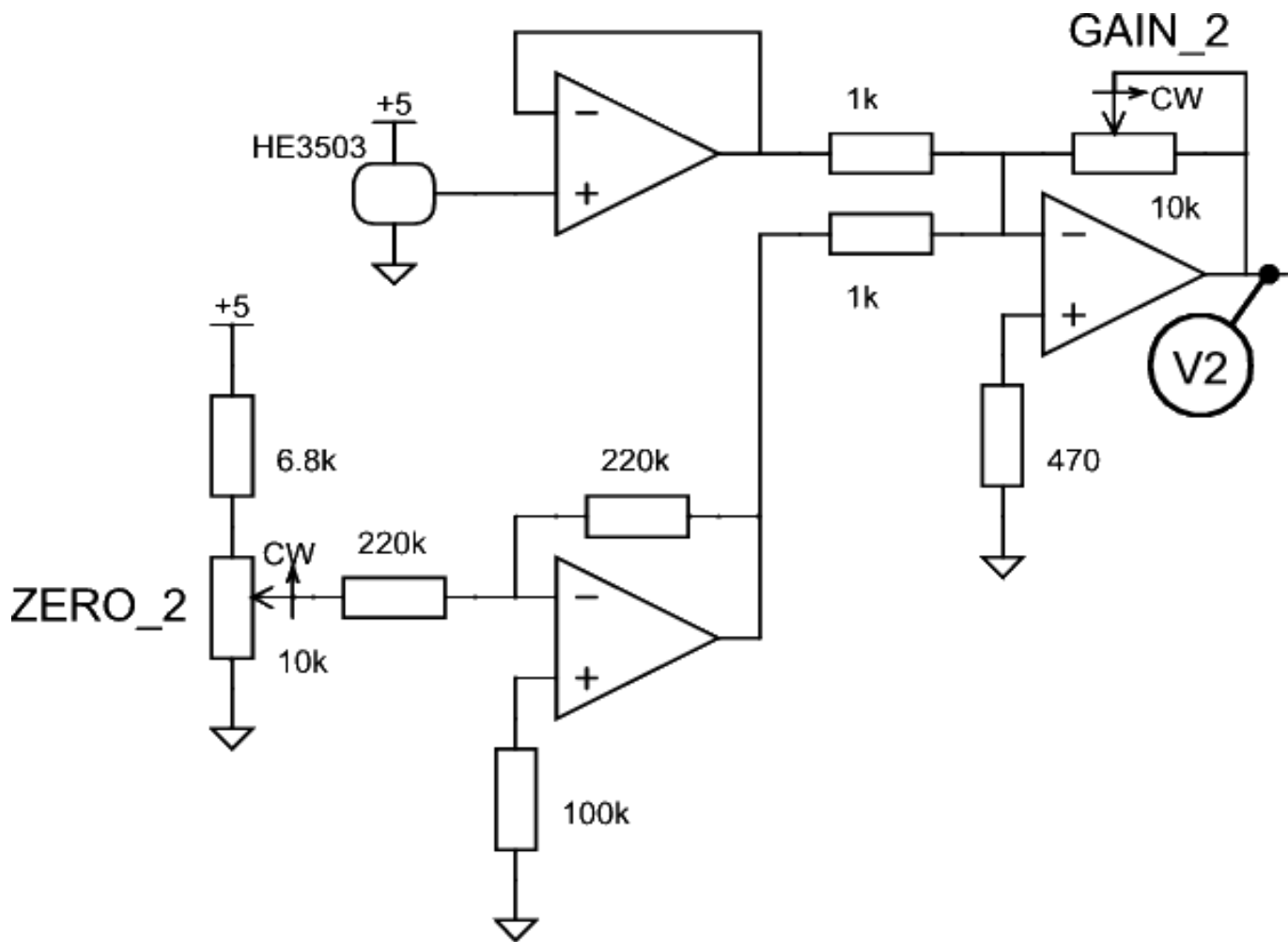

This circuit that combines V1 and V2 is slightly different, no diodes are around the op-amp for V4. This way, V4 can go positive or negative, depending on if the magnet is too far away, or too close. Stopping at zero simply shuts off the electromagnet. Going negative causes the electromagnet to push the magnet away.

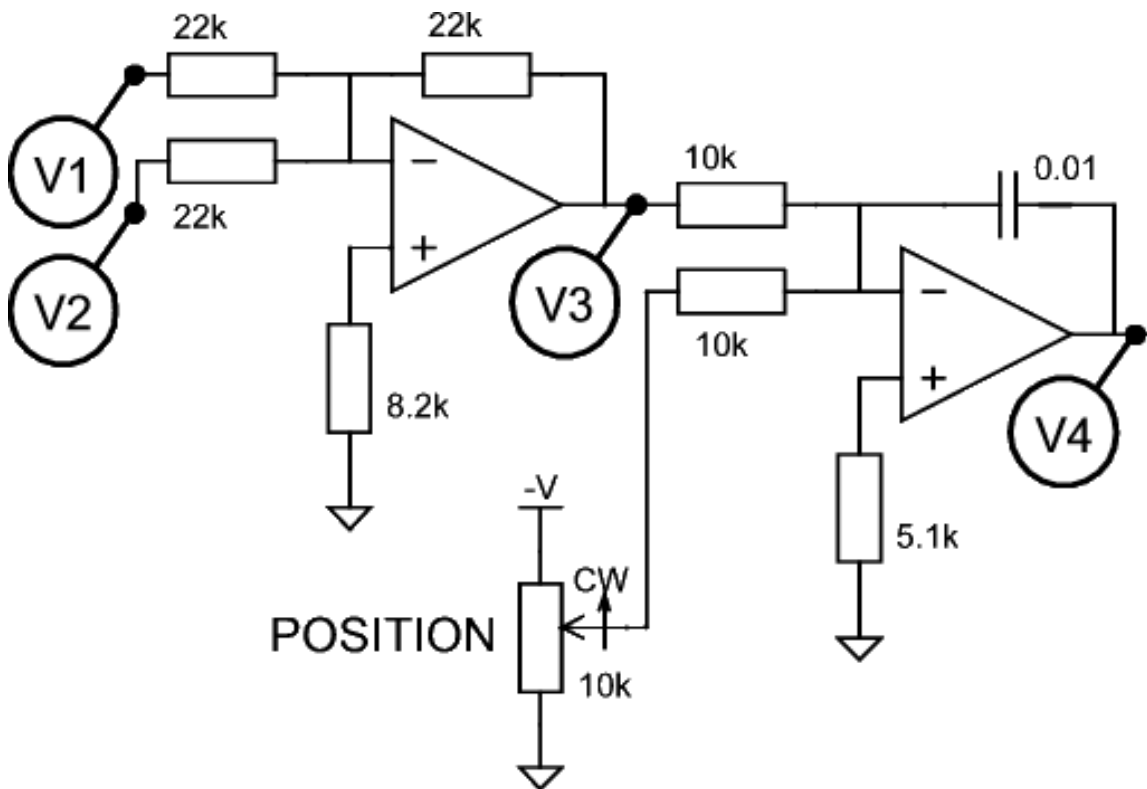

This power op-amp is from [Apex Microtechnology](#), P/N MP39. The +V and the -V can be anywhere between 15V to 50V, but power dissipation needs to be checked. I hope to try this circuit within the next few weeks. They have application notes, design spreadsheets and spec sheets for all their products - a great set of resource material! The MP39 is less than \$60, so it's not too expensive for what all it can do. It does need to be attached to a heat-sink to keep it cool. With it, we can power the electromagnet directly with an analog voltage, either polarity, with very quick response. It can also be set up to directly control the current in the electromagnet, not just the voltage across it.

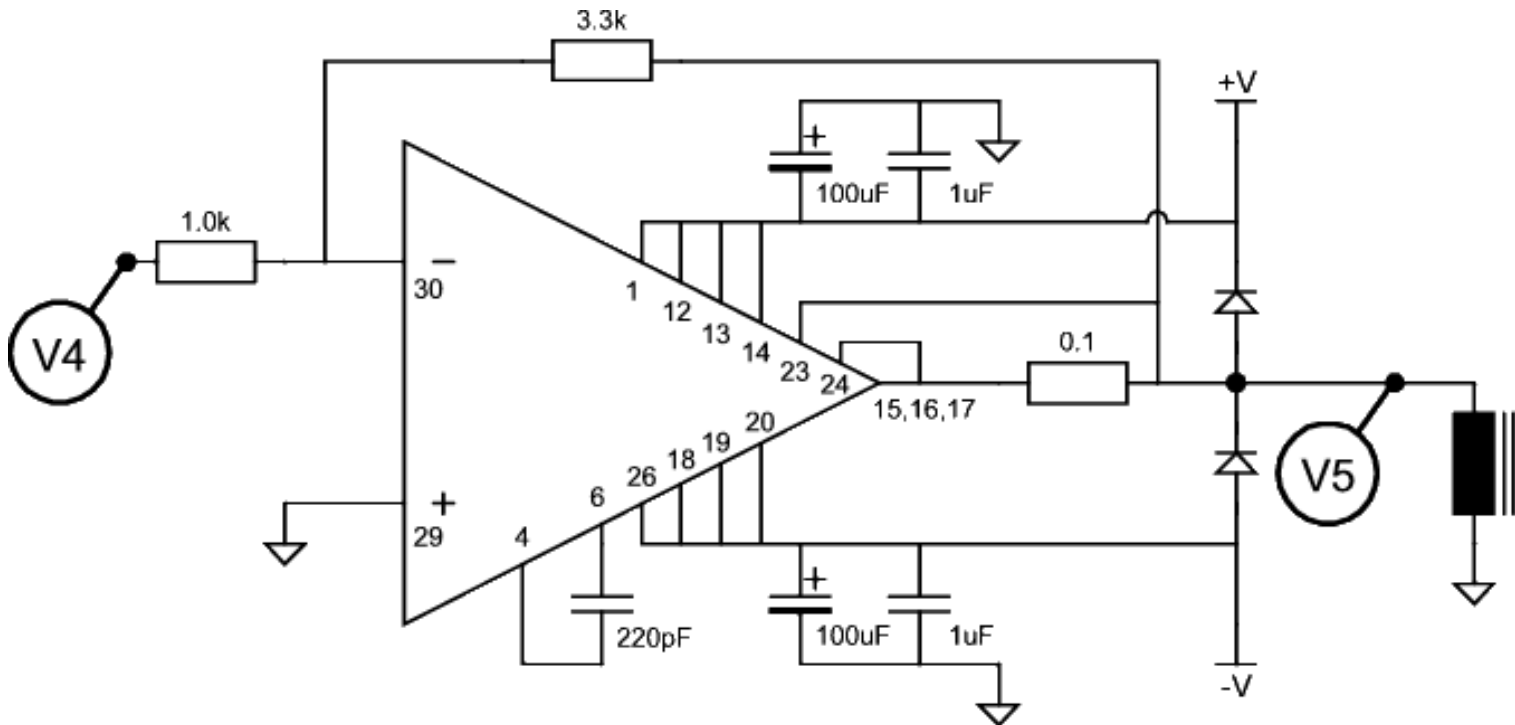

I will use a power op-amp to perform the power control for the electromagnet. The power op-amp has a gain of 3.3 of the voltage on V4. So, V5 would have a max voltage of about 30V, either plus or minus. When V4 is positive, V5 will be negative. The power op-amp will also be able to supply the current needed for the electromagnet. It can handle a maximum of 10 amps at plus or minus 50 volts max. So, this is a good fit. The power op-amp has several pins on it that need to be properly connected as shown. This provides a current limit function of 7 amps, provides proper compensation for the gain we are operating at, and multiple pins are used for the power and output in order to handle the high current involved. The diodes connected between V5 and the plus and minus supplies allow for freewheeling current from the electromagnet. Without these diodes, the op-amp would be damaged due to the inductance of the electromagnet. The 100uF caps are electrolytic. The 1uF caps are ceramic, and mounted very close to the op-amp. The 220pF cap is for compensation, and is ceramic or film. To work right, the connections to the electromagnet may need to be reversed from what they were using the IGBT circuit.

Other Applications

What else could we do with a circuit using the power op-amp? How about these ideas:

- 1) If the electromagnet were mounted sideways, the magnet would be positioned a fixed distance from the end of the electromagnet. Its distance would be controlled by the POSITION pot.
- 2) Taking this another step, the magnet could be mounted onto a short end of an arm, with a pointer on the opposite end of the longer arm, and pivoted close to the magnet. The electromagnet would be able to control precisely the distance of the magnet on the arm from the electromagnet, making it act like a recording head for a hard drive.
- 3) If just one hall effect device were used, and the POSITION pot were set fully CCW, then it would act like an "anti-magnet", since it would repel either a North pole or a South pole. This would surprise most people. It could even work without a steel core. It wouldn't matter whether the electromagnet were mounted vertically or sideways. It could even be upside down, and it would push a magnet away, levitating it in the air, pushing from below. The magnet would have to be constrained somehow.

Perhaps you can think of other uses as well!

Have fun experimenting!!!





Experiments with motors

AC Motors EXPT

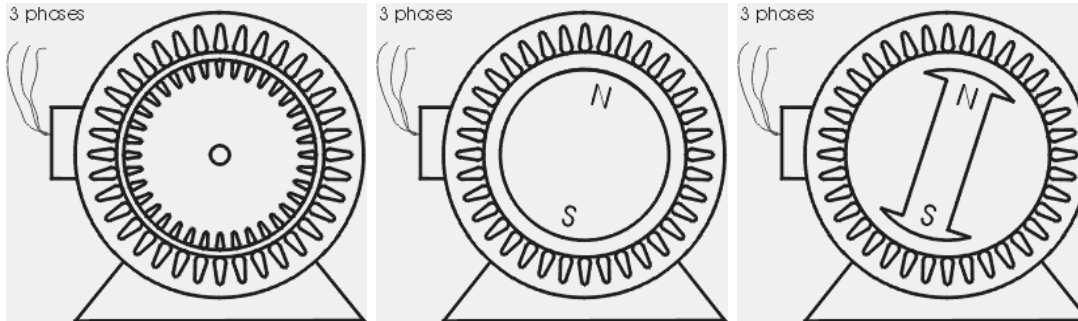

AC motors are also fairly simple to understand. They are a little trickier to make but will need single-phase or three-phase AC power to make them work. In the little diagrams above, we have a squirrel cage ac induction motor, a permanent magnet synchronous machine, and a synchronous motor. The inventor of the three-phase AC motor was [Nikola Tesla](#), a pioneer in electromagnetism.

Here are some great sites which describe how AC motors work and how to design them.

<http://mot-sps.com/motor/tutorial/index.html>

http://www.cpo.com/CPOCatalog/EM/em_curr.htm

<http://instantweb.com/o/oddparts/acsi/motortut.htm>

<http://www.westernelectric.com.au/index.html>

<http://www.appliedproactive.com/effmotor.html>

<http://www.motorsoft.net/>

<http://www.ifr.ing.tu-bs.de/java/java.html> (shows the changing magnetic fields in a 3-phase motor and how they create a rotating magnetic field)

<http://www.magsoft-flux.com/> (shows a Flux2D animation of the fields within a motor)

There are a couple types of basic AC motors you can build. They also make super science fair projects.

http://www.cpo.com/CPOCatalog/EM/em_home.htm

<http://www.eskimo.com/~billb/maglev/linmot.txt>

<http://www.italtec.it/enkitmo.htm>

A Very Simple AC Motor



Here is a photo of a very simple eddy current AC motor I put together. I think this one wins the prize for the Simplest AC Motor you can make. It works great and is very easy to build. I found the original plans in a book titled: "Physics Demonstration Experiments" by Harry F. Meiners, Vol 2, Ronald Press Co., NY, 1970, LCCC #69-14674. With some experimentation, I found that the can spins faster when the nut is on the end of the bolt than when the nut is removed. What do you think will happen if the rotor is moved to the other side of the bolt? It consists of a coil mounted onto a 3/4" bolt. The coil is about 100' of 20AWG wire, on a form about 1.5" long, with a dc resistance of about 1.2 ohms, and an inductance of about 2.4mH as an air-core inductor. The voltage supplied to the coil is 19Vac from a plug-in transformer and supplies about 2.5Aac to the coil. The rotor is an aluminum film canister (today they use plastic, but you might still find a few of these around - ask your friends) with a dimple in the bottom of it, resting on a pencil. (I figured that the graphite in the pencil will lubricate the rotor.)



The eddy current motor on the left has two rotors, they spin in opposite directions. The set-up on the right shows a variac, multimeter, eddy current motor, and a calibrated strobe. With this, we could plot speed vs. voltage. We found that the rotor would spin about 1000 rpm with 120V applied to it. Can't keep it there for long, since the coil and bolt get real hot. On these two coils, a smaller diameter wire was used, so the dc resistance was about 11.2 ohms, and 24mH as an air-core inductor. With this, we could apply 120Vac to it and only 2 amps would be drawn.

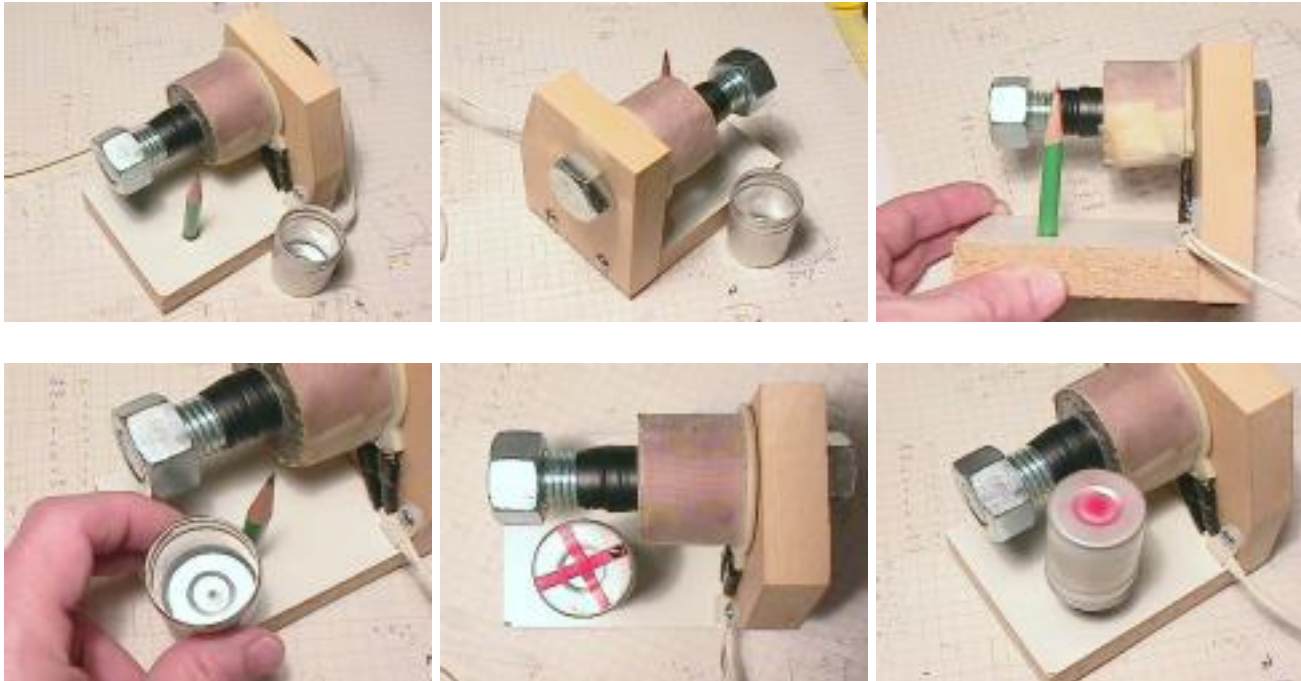

This shows the basic construction. The bolt is a 4" long 3/4-13 bolt, the wood is 3/4" thick. I put a small dimple into the bottom of the aluminum film canister so it would sit onto the pencil point. The red strips of tape helped with the strobe and looks cool as it spins. I found that the nut on the end of the bolt makes it go faster.

A Shaded Pole AC Motor

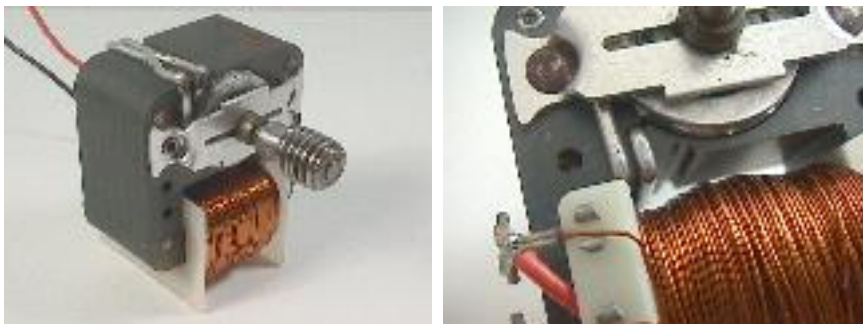

Here is a photo of a typical shaded pole motor. See the close-up of the notch in the laminations and the extra heavy winding of two turns creating the

phase difference between the two sections of the laminations, giving the magnetic field a directional motion. The rotor spins CW as seen from the end with the screw on the shaft. Motors like this are used in thousands of applications.

Another Shaded Pole AC Motor



Here is a photo of a ceiling fan motor, also shaded pole, but with six windings instead of only one as seen above. The rotor laminations are skewed to provide smoother torque. The pole pieces with the windings have a slot in them to create a delayed flux, creating a direction for rotation.

A Universal Motor



And here is a photo of a universal motor. It has brushes like a DC motor, but will operate on AC or DC.

A 3-Phase AC Motor Demonstrator



Here is a project my daughter is working on. It shows how a 3-phase AC motor works with a rotating magnetic field and a permanent magnet rotor, making it a synchronous AC motor. We have pushbuttons which allow the user to turn on any one of the pairs of opposite coils, in either a N-S or a S-N orientation. For example, the green button turns on the horizontal pair of coils in a S-N orientation. The yellow button turns on the horizontal pair of coils in a N-S orientation. On each coil is a bi-color LED to indicate the magnetic polarity of the coil when it is turned on. The power to the coils (each pair connected in parallel) is supplied by a 5v computer power supply.

The coils draw about 4amps at 5Vdc each, so a supply with 23amps available is a great match. Each coil is mounted on a 3/4" bolt, attached to a hinge. This way, sets of coils can be folded down out of the way to show how a shaded pole motor works. The rotor is a bar of steel with a NIB magnet on each end. The rotor does oscillate a bit when going from coil to coil.

Here's more photos:

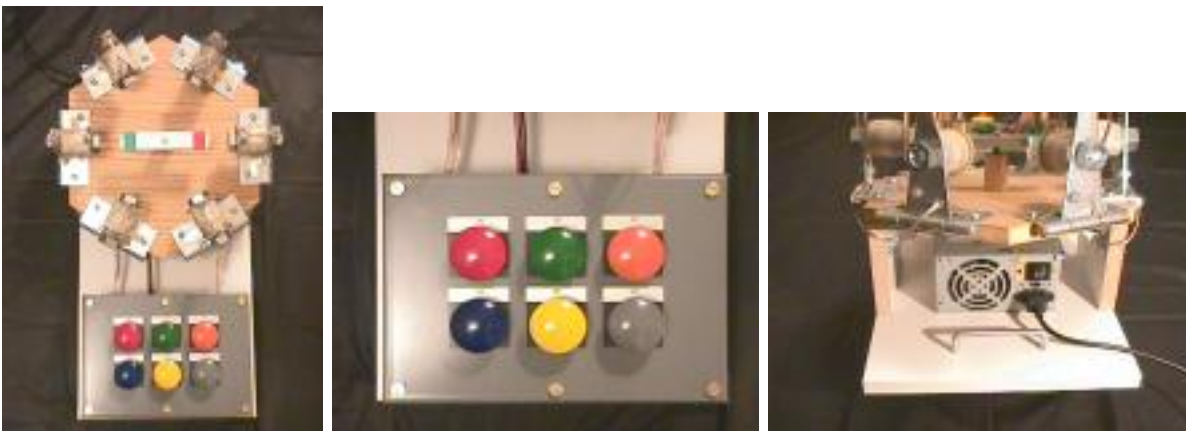

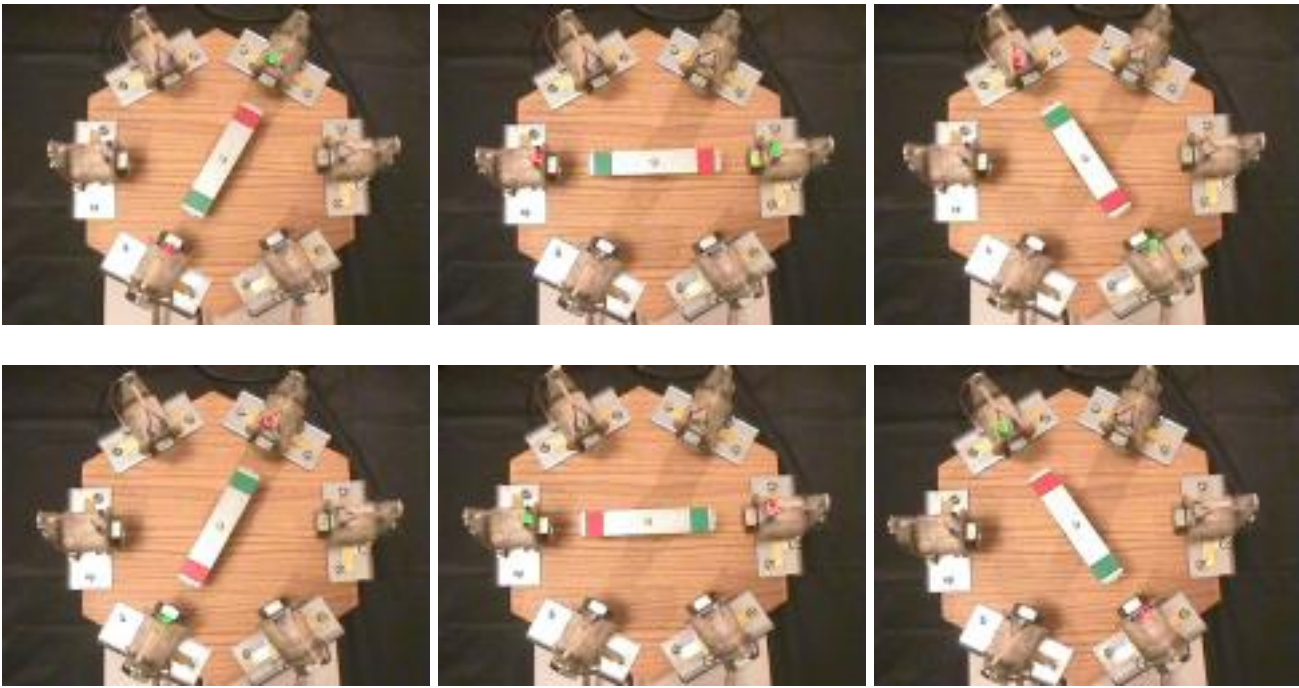

By pressing the colored buttons in the correct sequence, the rotor will follow the magnetic field in a clockwise fashion. The faster you go through the sequence, the faster the rotor will rotate. This shows that the speed of this motor is dependant on the frequency of the power applied to it. The higher the frequency, the faster it goes. At 60Hz, it would rotate at 1 revolution/cycle * 60 cycles/sec * 60 sec/min = 3600 revolutions per minute or rpm.

Three Phase AC Motor Stator



Industrial AC Motors



These are cut-aways of actual industrial three phase AC motors. They have different HP ratings, from 5hp, 2hp, 900hp. They are manufactured by Reliance Electric, part of [Rockwell Automation](#).

Linear motors

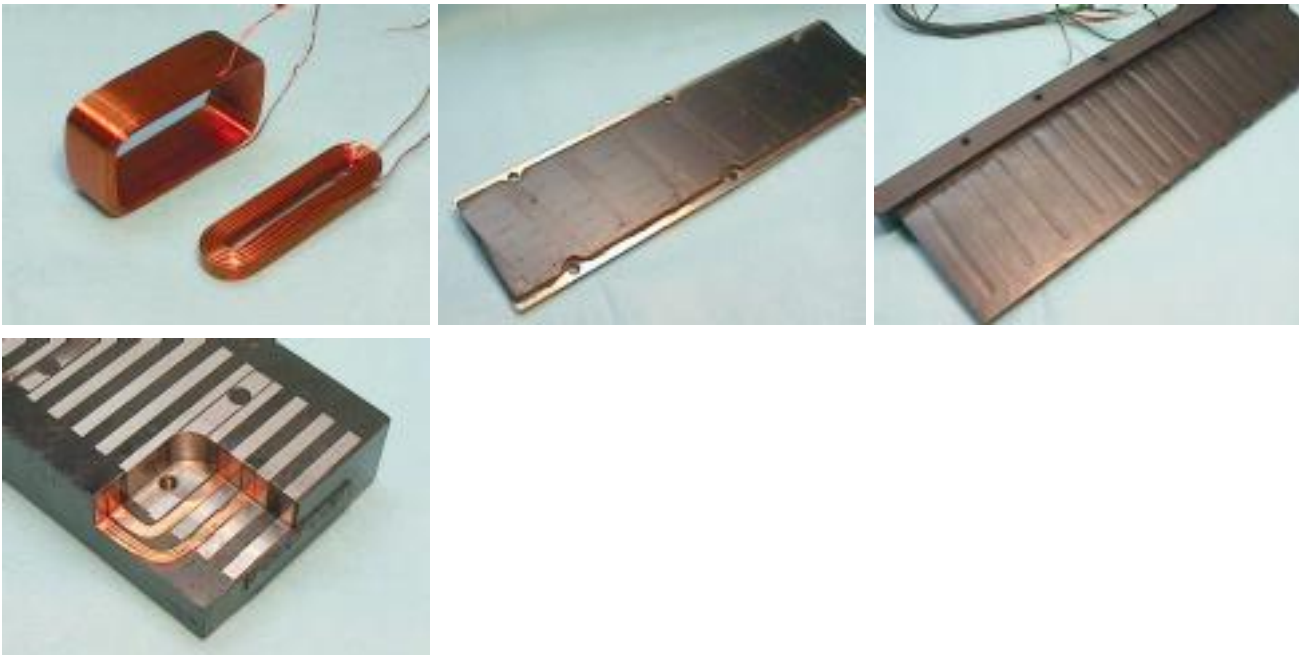

A linear motor is like an ac motor, but it is unwrapped and layed out flat. The photos show parts of linear motors. Some have flat coils and magnet sections, others are "T" shaped. Check www.anorad.com for more info.





Experiments with magnetic levitation

Suspended Objects

There's a super article in Popular Electronics, May 1996, pp 48-52, 78, titled "Build a Magnetic Ball Levitator", by James Cicon. It describes how to build an electromagnet with an optical sensor which will keep a hollow steel ball floating in the air about 1/4" below the electromagnet.

This is like the globe of the earth which is suspended in air under an electromagnet that can be purchased for about \$125. The material costs for this project is only about \$20.

A copy of the article should be obtainable from your local public library.

A place on the net with something like this can be found at:

<http://www.aussiemagnets.com.au/millennium.html> (a new item, looks great!)

<http://www.magnetics-research.co.uk/homepage.htm>

http://www.internetsites.co.uk/floating_systems/index.htm

Some other sites on this are:

<http://www.weizmann.ac.il/physics/complex/mula/mulamag.html>

<http://www.dimi.uniud.it/~franco/SysDynLab.html>

<http://iawww.epfl.ch/Laboratories/levitation/LevitationFrame.html>

<http://www.brucegray.com> (cool magnetic sculptures)

Another way to suspend an object is by using a solenoid. Check this page on [solenoids](#).

Still another method is to use diamagnetics.

<http://www.scitoys.com/scitoys/scitoys/magnets/suspension.html>

Zero-Gravity Levitator



This is a super toy! Very new (at least for me)! It is from www.unusualdevices.com for Discovery World, and costs about \$50. It stands just over 11" high, the globe is 3" in diameter, and comes with its power supply which plugs into the 120Vac wall outlet. On the back is where you plug in the power supply, there is also an on/off switch and a switch which turns on the rotating function. This will cause the globe to rotate at a rate of about once every 3 seconds. This is accomplished in a very clever way: in the base are two coils, perpendicular to each other, which has a NIB magnet on edge in their middle. When the rotating function is on, the coils cause the magnet to rotate, which in turn affects the NIB magnet which is located in the bottom of the globe, on its edge, causing the globe to rotate. On the front left of the base is an orange knob which can be rotated,

adjusting the distance between the top of the globe and the bottom of the electromagnet (which is contained in the top, pointed part of the toy). There is a large NIB magnet in the top of the globe. I works very well. The globe comes apart, and an additional 1.5 ounces can be placed in the globe. More than that will cause it not to float. The only drawback is that when power is interrupted or the unit is turned off, the globe falls and hits the base. One of these times, it will break. I may need to place some padding under the globe, formed to catch and hold it if and when it falls.

(seems like www.unusualdevices.com disappeared! Try getting it from [Edmund](http://www.edmundscientific.com) 30825-32)

To make your own [magnetic levitator](#), go to the next page!





Experiments with electromagnets

DC Electromagnet

Description:

A DC electromagnet is simply a coil of wire connected to a DC voltage source. It can have an air core or an iron core.

Construction: EXPT



The construction would be the same as the [AC electromagnet](#). The difference would be that instead of connecting it directly to the output of a variac, connect the output of the variac to a diode bridge (shown in the photo), and connect the coil to the DC output terminals of the diode bridge. To smooth out the DC output, a capacitor can be connected in parallel with the coil.

Demonstration:



It can be shown how the DC electromagnet will pick up several paper clips. Next, turn the variac down to zero, to show how most of the paper clips fall off the end of

the bolt. There may be a couple that hang on.

Conclusions:

It behaves like a permanent magnet as long as there is power applied to it. It's a magnet that can be turned on and off, and its magnetic strength can be varied as the voltage to it is varied. In fact, for the same voltage out of the variac, there will be more current flowing in the DC electromagnet than the AC electromagnet (no inductive reactance in the circuit), so it will be a stronger magnet!

The polarity of the magnetic pole at the end of the bolt does not change like the AC electromagnet does. It will be either a North or a South magnetic pole, depending on how it is connected to the output of the diode bridge.

For a simulated diagram of the field around this electromagnet without an iron core, [look here](#).

For a simulated diagram of the field around this electromagnet with an iron core, [look here](#).

An Easy Electromagnet Experiment EXPT



Making an electromagnet isn't hard, but understanding all of the variables involved can seem a bit overwhelming the first couple of times. Here's an experiment that's easy to make and do some measurements.

What you'll need are the following:

- Set of magnet wire spools (Radio Shack p/n 278-1345B)
- 200' of 30 AWG wire
- 75' of 26 AWG wire
- 40' of 22 AWG wire

Steel bolt, $\frac{3}{4}$ -13 thread, 2" long

Computer power supply, 5V, good for 8A or more, or a large 6V lantern battery

Sandpaper, 100 to 200 grit, 2" square

BB's, 3000 steel BB's in a plastic bowl

The steel bolt can be obtained from most hardware stores. The sandpaper can be picked up there, too.



Computer power supplies, like those used for tower computers, are usually rated between 140W to 250W. They supply 5V at 8A or more, as well as +12V and -12V and -5V at much lower currents. We will want to use the 5V supply since that works much better than a battery. If you don't have one, go to a computer store and ask if they have one that is broken, but the 5V supply still works. I got one for free that way. A new one is fine, but costs more. The +5V is usually the red wire. Find a connector with three of them and use all three in parallel for your supply. On the same connector should be two or three black wires as the common. Use them in parallel for your other connection. (+12V is usually the yellow wire, -12V is usually blue, and -5 is often white: don't use them.) If you want, you could use a 6V lantern battery, like the one pictured here. A smaller size battery will not be able to supply the current and will last for only a short time.



BB's are steel balls about 4.5mm (0.177") in diameter that are used with BB guns. I bought a bunch of them at a sporting goods store. When you go, take a magnet with you to make sure that they are made of steel.

There are three key items that affect the design of an electromagnet, and each of them have several sub-items that need to be considered. They are the coil, the core,

and the power source. Let's look at each one.

1. The coil

- The diameter or gauge of the wire used for the coil.
- The length of the wire used for the coil.
- The number of turns of wire around the core.

The above parameters affect the dimensions of the coil: its inside diameter, outside diameter, and length. These dimensions, along with the size of wire used, determines the length of wire needed and the resistance of the wire.

2. The core

- The size of the core.
- The material used for the core.

Is the core going to be air, or will it be steel? Will the steel be laminated or solid? What shape will it have?

3. The power source

- The voltage powering the coil.
- The frequency of the voltage powering the coil

Is the power source DC or AC? If AC, what is the frequency? What is the duty cycle (how long is it on versus how long is it off)?

Why do all of these things affect the strength of the electromagnet? Because the one item that has the biggest effect is called the **Ampere-turns**. This is simply the number of amps of current flowing in the wire of the coil multiplied by the number of turns of wire there are around the core. So, length of the wire, its diameter, the size of the winding, and the source all affect either the amps that will flow or the number of turns that exist or both.

Let's see how this works.

In the packet of magnet wire from Radio Shack, you get three spools. On one spool is 200 feet of 30 gauge of wire. It has a reddish color to it. It's resistance is about 20 Ohms. With 5 Volts on the coil, the amount of current that would flow is

equal to the voltage divided by the resistance, or $5/20 = 0.25$ Amps. I figured there are about 800 turns of wire on the spool. So, the Ampere-turns is $0.25 * 800 = 200$. This is saying that the strength of the magnet would be same no matter how you get the 200 Ampere-turns. For example, you could have 200 Amps, and 1 turn, or 1 Amp and 200 turns, or any other combination. The effect would be the same in terms of the overall magnetic field created by this coil.

What happens when we look at the other spools? This table summarizes the data.

Length, feet	Gauge, AWG	Resistance, Ohms	Voltage	Current, $I=V/R$	Number of turns	Ampere-turns
200	30	20	5	0.25	800	200
75	26	3	5	1.67	350	580
40	22	0.65	5	7.7	160	1230

This is saying, that for the same voltage connected to each of the coils, the coil using the 30 AWG wire would be able to pick up a certain number of BB's. The coil using the 26 AWG wire would pick up about three times as many BB's. And the coil using the 22 AWG wire would pick up about six times as many BB's as the first coil, and two times as many BB's as the second coil. We will use picking up BB's as a way to compare magnetic field strengths. You could also use paperclips or nails, or staples, but BB's work well and are fairly easy to count.

One other thing we need to keep in mind. When current flows through the wire, it creates heat. Will the coil get too hot? First, find out how many watts will be dissipated by the coil. For the third coil in the table above, the watts = $I^2 * R = 7.7 * 7.7 * 0.65 = 38$ watts. There needs to be enough surface area so that the watts/sq.in. is no more than 0.5. In this case, the watts/sq.in. works out to about 9.5, which is a lot more than 0.5! So, expect the coil to get hot and don't keep in on continuously. It's OK to run it for 10 seconds, then turn it off for 30 seconds to be able to cool.

Let's try this out!

Take each coil and clean off about $\frac{1}{4}$ " of the varnish on each end of the wire on each spool. Use the sandpaper to do this. Fold the sandpaper in half and pinch the wire between the paper and pull the paper straight off the wire. After a dozen times, you should start to see the copper color of the wire appear. This is very obvious on the red varnish and the green varnish wire. It's harder to see on the clear varnish wire. Do this to both ends of the wire on each coil. One end sticks out of a small hole in the middle of the core. The other end will need to be unwound one turn from the outside of the coil. The reason for this is to be able to

make a good electrical connection to the wire.

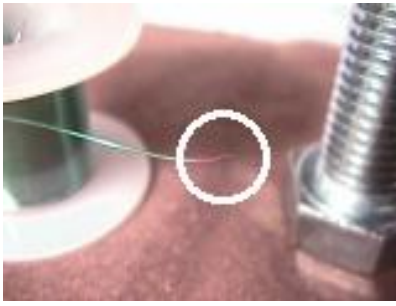

I kept the wire on the spools since it is neatly wound, and the hole in the middle of the spool is a good fit for a bolt.

Next, drop the $\frac{3}{4}$ " bolt into the middle of the core of the spool of 30 AWG wire. This helps to concentrate the lines of magnetic field within the steel bolt instead of letting them disperse in the air.



Connect the coil to the 5V power supply. If you have a multi-meter that can measure the currents we anticipate in the table above, connect it between the power supply and the coil.

Now, pick up as many steel BB's as possible, and hold them over a separate container, and disconnect the power supply from the coil, causing the BB's to fall into the separate container. Reconnect the power supply, and again pick up as many BB's from the first container as possible, and drop them into the second container. Do this for a total of 10 times. Now, count the number of BB's in the second container and divide that number by 10. This will give you the average number of BB's that electromagnet can pick up.



Next, do the same thing with the second spool of 26 AWG wire. Find out the average number of BB's it can pick up. You will notice that this spool of wire will start to get a little warm.



Finally, do the same thing with the third spool of 22 AWG wire. This spool will get much warmer. If it gets too hot to hold, disconnect the power supply from the spool of wire for a few minutes to give it time to cool off. Again, your goal is to find out the average number of BB's it can pick up.



With this data, compare the number of BB's using each coil. How do the ratios of the numbers compare? Is it close to what we expected? Were you able to measure the current? Are they close to what we expected? If not, what could affect that value?

What else could you do? You could wind the wire onto a 1/4" diameter bolt, and get a lot more turns using the same length of wire. This would increase the Ampere-turns of the electromagnet. Changing the voltage of the power supply would also affect the strength, so, using the 6V battery instead of the 5V power supply means more current, and thus more Ampere-turns.





Experiments with electromagnets

Electromagnets

What is an electromagnet?

An electromagnet is simply a coil of wire. It is usually wound around an iron core. However, it could be wound around an air core, in which case it is called a [solenoid](#). When connected to a DC voltage or current source, the electromagnet becomes energized, creating a magnetic field just like a permanent magnet. The magnetic flux density is proportional to the magnitude of the current flowing in the wire of the electromagnet. The polarity of the electromagnet is determined by the direction the current. The north pole of the electromagnet is determined by using your right hand. Wrap your fingers around the coil in the same direction as the current is flowing (conventional current flows from + to -). The direction your thumb is pointing is the direction of the magnetic field, so north would come out of the electromagnet in the direction of your thumb. DC electromagnets are principally used to pick up or hold objects.

When connected to an AC voltage or current source, the electromagnet will be changing its flux density as the current fluctuates. The polarity of the magnet will also change as the current reverses direction every half cycle. AC electromagnets can be used to demagnetize objects (like TV screens, audio tapes, vcr tapes) or to hold objects. However, due to the inductance of the electromagnet, the AC current that will actually flow will be reduced when compared to a DC voltage equal to the RMS value of the AC voltage feeding the electromagnet.

The key importance of an electromagnet is the ability to control the strength of the magnetic flux density, the polarity of the field, and the shape of the

field. The strength of the magnetic flux density is controlled by the magnitude of the current flowing in the coil, the polarity of the field is determined by the direction of the current flow, and the shape of the field is determined by the shape of the iron core around which the coil is wound.



Here is an example of the yoke of a TV. It is made of two sets of electromagnets, perpendicular to each other, and mounts onto the neck of the TV tube. The current flowing through these wires controls the electron beam going to the screen of the TV, causing the beam to trace out a raster or series of horizontal lines, one after the other, from the top of the screen to the bottom, and then back to the top again for the next frame. This creates the picture we see on the TV screen. One set of windings moves the electron beam from left to right, the other set moves the electron beam from top to bottom.

Winding a coil EXPT

Before you can start with the construction of an electromagnet, you first need to figure out the following:

1. What will the core be made of
2. What magnetic flux density are you trying to achieve
3. How many turns will be required for this along with
4. How many amps will be flowing through the wire
5. How big will the wire have to be to handle the current
6. How much surface area will you have for cooling the coil
7. How big will the electromagnet be due to the above
8. What voltage rating will the insulation of the wire have to withstand
9. What will be the inductance of the electromagnet
10. Obtain the core, wire, bobbin (form for the winding)
11. Wind the coil

12. Test the electromagnet

As you can see, there may be some times as you go through these steps that once you get an answer, you may have to go back a step or two and make some modifications, and recalculate. This is an iterative process.

To help, I use the following excel spreadsheet. Please feel free to use it. No warranties are implied. There may be errors, but I don't think so. There is definitely room for improvement. [Coildata excel file](#). Simply save it to disk, and then open it. Fill in the data needed in the green boxes. It will calculate the length of wire in a coil, the resistance, and get an approximate inductance for an air core if you want to play with some numbers.

Here are some excellent sources for help in building an electromagnet or coil.

<http://www.ee.surrey.ac.uk/Workshop/advice/coils/index.html>

A couple of things to keep in mind:

1. Use magnet wire with an enamel coating
2. If winding it onto a metal bar or bolt, first wrap the metal with one or two layers of electrical tape so the winding does not short out to the metal.
3. It takes time and care to do a clean, even winding.
4. After the first layer, wrap the layer with a thin piece of paper, or another layer of electrical tape, to provide a smooth surface for the second layer to lay on. Repeat this for each layer, or at least for every three layers.

When working with electromagnets, I have found that having a variac (a variac is a variable autotransformer) has been a great help. This provides a variable AC voltage source. When you plug something into it, you can adjust the output voltage anywhere from 0 to 140Vac. I start with it at zero, then slowly bring it up, watching the current and voltage. This way, I have control over what happens if there is a problem or a limitation. By connecting a diode bridge to the output of the variac, you also get a variable DC voltage source. They are rated by how much current they can handle. Choose one that can handle 2 or 3 amps minimum. As the amp rating goes up, so does the price. Here are two source for variacs:

<http://www.tenma.com/070.html> and <http://www.actionelectronic.com/phcva.htm> . The cost

of \$100 is not bad for a 10 amp unit with a built in ammeter (a meter that measures amps)!

Transformers EXPT



A transformer is simply two electromagnets which are magnetically coupled together. There is electrical isolation between the two windings, but power can be transferred from one winding (the primary) to the other winding (the secondary) via the alternating magnetic field. They work on AC voltages. The ratio of the secondary output voltage to the primary input voltage is equal to the ratio of the number of turns in the secondary winding to the number of turns in the primary winding. (i.e., $V_{out}/V_{in} = N_{secondary}/N_{primary}$)

The photo on the left is a control transformer, and takes 230Vac in and drops it to 115Vac out for control circuits in industry. You can also turn it around and put 115Vac in and get 230Vac out. Transformers have a kVA rating which is the rated output Voltage times the rated output Amps divided by 1000. The one above is rated at 0.200kVA or 200VA. The two photos on the right show how to demonstrate the transformer action using two coils and the AC electromagnet from our electromagnet [experiments](#).

Here are sources for what is needed to design and build autotransformers and electromagnets:

<http://www.rale.ch/constru.htm>

<http://www.geocities.com/CapeCanaveral/2404/design2.html>



This transformer was called a Sparker or Ignition coil, used to create the spark needed for the spark-plugs in cars from the '30s. It has a few turns for a primary winding, and lots of turns for a secondary winding. The mechanism at the end would open and close the circuit several times a second creating an AC like voltage on the primary (Since it was operated from a 12V battery, and transformers don't work on DC, a method was needed to create an AC type of voltage on the primary coil). The secondary has thousands of turns on it, creating a high voltage of around 30,000V which will arc about 10mm through the air.

Jacob's Ladder using a neon sign transformer EXPT



This Jacob's Ladder uses a transformer which creates 15,000Vac on the secondary coil when 120Vac is applied to the primary coil. I built a box around the unit I show here. It has a plexiglas front to keep curious fingers away from the wires. Be very careful with this!

Battery Powered Electromagnet capable of holding 500 lbs! EXPT



This is a lifting electromagnet from www.sciencefirst.com which is capable of holding 500lbs with just 2 D cell batteries! It costs about \$55, but is quite a nice unit! It is their model number 20-035. They also have a slightly smaller electromagnet, model number 20-030, for about \$47, which will hold 200lbs with just 1 D cell battery! The smaller unit is also available from Edmund Scientific as P/N 60-435.

It is made of two parts - the yoke which also contains the coil, and the plate. The secret to the large holding force is that the plate and yoke are carefully machined so that there is no gap between them when they are placed together. It came with some excellent instructions on experiments you can do with it. However, I modified the larger unit a bit in order to make it easy

to use on my wooden stand. Here's what I did.

First, I removed the battery holders that came with it. Then I soldered longer wires to it, along with two banana plugs and a 9v battery clip in order to connect an ammeter in series with either a 2 cell AA battery holder or a 4 cell AA battery holder from Radio Shack. I also put a cable clamp on it so there wouldn't be any strain on the wires from the coil assembly. Then I put a longer eye bolt into the plate, and secured it with a flat and lock washer.

The Plank EXPT



The wooden stand is made from a 4x4, 30" wide, and the two vertical supports are 18" tall each. The flat board or plank on the floor is a 2x10, and is 36" long. The cross piece at the end of the 2x10 is a 2x4, 30" long, to help stabilize the 2x10 when someone is on it. The photos show the construction details. The bolts on the horizontal 4x4 piece are 1/2" x 8" carriage bolts. I also have a string on the plate so that it won't crash to the floor or to the plank.

The demonstration calls for a volunteer who will walk the plank toward the electromagnet. When he is standing at the electromagnet, it is then holding his full weight. If someone (an anchor person) were to stand on the end of the 2x10 where it is attached to the 2x4 cross piece, and the volunteer were to stand on the 2x10 at the far end, then the electromagnet would be holding

1.5 times the volunteer's weight. (The anchor person will need to weigh at least half of the volunteer's weight, otherwise the anchor person will be lifted up, like a see-saw!) When the volunteer is on the plank near the electromagnet, then disconnect the battery and watch the plate of the electromagnet pull away from the yolk of the electromagnet, causing the volunteer to drop about 1.5" to the floor - proving that the batteries were able to convert enough chemical energy into electrical energy, the electromagnet's coil was able to convert the electrical energy into magnetic energy, and the electromagnet's yoke and plate were able to convert the magnetic energy into mechanical energy, in order to hold the volunteer's weight! Pretty amazing!

With four AA batteries, I know it can actually hold at least 300lbs. With two AA batteries, I know it can hold at least 225lbs, but less than 300lbs. I wanted to use AA batteries instead of D batteries since they were smaller and the effect is more dramatic! I call this demo "The Plank"!

Audio Speakers EXPT



Speakers are made by placing a one layer coil of wire, wound onto a tube, into a magnetic field. The end of the tube is attached to the center of the paper cone of the speaker. When current is passed through the coil, a force is created on the coil, causing it and the tube to move within the magnetic

field. When the current reverses direction, the coil and tube move in the opposite direction. This uses the Left Hand Rule.

The photos above show a speaker and a magnet used for a speaker coil and its tube. The field is between the center post and the outer portion of the circular slit.

The speaker shown in the lower three photos will be dissected so you can see what the insides are like.



First, cut the wires going to the terminal strip. Then take a mat knife and carefully cut the cone around the edge. Let the knife follow the metal frame.



Next, you will need to hold the cone away as you carefully cut the inner paper disk, usually brown colored. You can then lift the cone and voice-coil assembly out of the magnet and frame. You can see how the magnet is made with a circular slit in it, where the center is a South pole, and the outside ring is a North pole (at least in this speaker). As current flows through the coil, it interacts with the magnet. The faster the current changes direction (the higher the frequency of the signal), the faster the cone moves in and out creating a higher frequency sound. The larger the magnitude of current, the farther the cone travels in and out of the magnet, the louder the sound. Connecting a battery to the speaker will cause the cone to pull in or push out a bit and stay there as long as the battery is kept connected. Reversing the battery connection will change the direction the cone moves (if it went out first, changing the battery around makes it go in the second time). Use a 1.5V battery for this test. This same effect is also demonstrated with the [Fleming Left Hand Rule demo](#).



These are close-ups of the magnet, and the cone and voice-coil assembly. The voice-coil is the electromagnet, or solenoid. It is made with a very fine (small diameter) wire, with only two layers. It is then soldered to the flexible wires which you see on the left which attach to the terminal block. These wires are very flexible since the whole speaker cone goes in and out of the magnet in order to create the sounds.



The speaker in the upper left is one like the 5" speaker cut open above. The larger speaker is a 15" woofer from Radio Shack. Place some small wooden or glass beads into the middle of the speaker cone, and attach a signal generator to the speaker terminals. As you vary the frequency and volume, the beads start to dance on the cone. Fun to watch!

Make A Speaker! EXPT



Have you ever wanted to make your very own, working speaker? Here's a great way to make one, and it's simple, too! I am grateful to [Michael Gasperi](#) for his suggestion and for this kit that he created.

The materials you will need are:

- 24" of 30AWG enamel magnet wire (from Radio Shack, p/n 278-1345B)
- 1.5" brass-coated steel brad
- ceramic magnet, 0.5" diameter, 3/16" thick (from Radio Shack, p/n 64-1883)
- a 1.5" square piece of 100 grit sandpaper
- a styrofoam cup



Take the wire, leave about 4" for a connection lead, and wrap the rest of it around the brad near its head. Keep the coil on the brad within 3/16" of the head as shown below. Again, leave about 4" at the end of the winding in order to make a connection to the coil.



Now, place the magnet under the head (it will stick to the head of the brad) and press the brad into the bottom of the styrofoam cup. Separate the two tines of the brad and press them against the inside bottom of the cup as shown here.



Finally, take the sandpaper and clean about 3/4" of each end of the wires from the coil in order to remove the enamel insulation so you can make an electrical connection to the coil. That's it! Just connect the two ends of the coil to a radio jack and you'll be able to hear the music.

If you want, find an old, unused set of headphones and cut off the plug with some of the wire attached to it. Solder the pair of wire ends to the ends of the coil (one insulated wire to one end of the coil, the other wire of the pair to the other end of the coil). Then you can plug it in directly. (You could also buy a 1/8" mini plug with alligator clips from Radio Shack, p/n 42-2421, and clip that onto the ends of the coil.)





Pentominoes

Pentominoes is the set of shapes created by combining 5 squares or cubes, with faces touching each other, in every possible combination. Mirror images and rotations do not count as additional combinations.

With this, we achieve 12 unique shapes, as seen below:

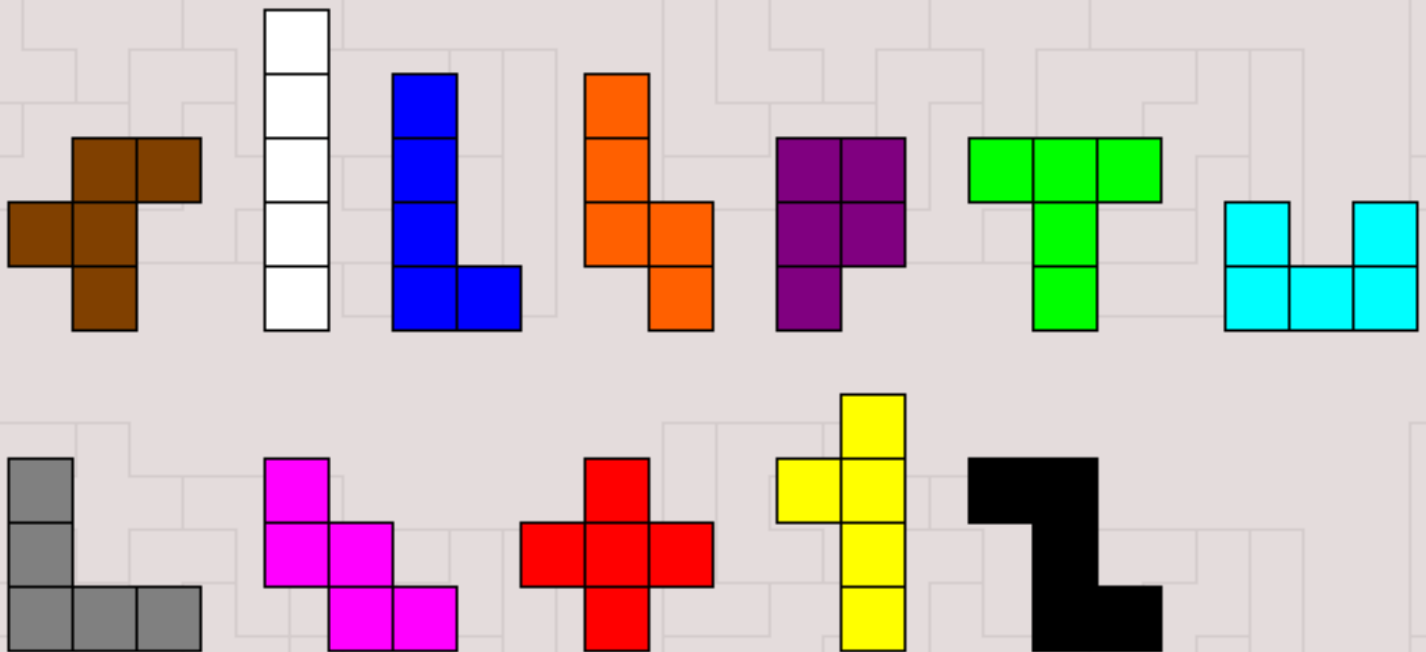

They tend to resemble the following letters, respectively:

F I L N P T U V W X Y Z

What can you do with these 12 puzzle pieces? You would be amazed!

(Remember, each piece contains 5 squares, so there are 60 cubes total.)

Using all 12 pieces, you can make:

1. A 6 x 10 rectangle (see photo below)
2. A 5 x 12 rectangle
3. A 4 x 15 rectangle
4. A 3 x 20 rectangle
5. An 8 x 8 square with 4 pieces missing in the middle (see photo below)

6. An 8 x 8 square with 4 pieces missing in the corners
7. An 8 x 8 square with 4 pieces missing almost anywhere
8. A 3 x 4 x 5 cube (see photo below)
9. A 2 x 5 x 6 cube
10. A 2 x 3 x 10 cube
11. A 2D replica of each piece, only three times larger
12. A 5 x 13 rectangle with the shape of 1 pentomino piece missing in the middle
13. Shapes with jagged edges
14. Tessellations using a pentomino
15. Hundreds of other shapes!

You can make your own set of pentominoes!

Run, don't walk, to the nearest craft shop and buy 60 wooden cubes, each measuring about 3/4" on a side. Glue sets of 5 together into each of the 12 pieces shown above. (Make sure the U isn't too tight for the others to fit into it!) Then, have hours of fun trying to create each of the above shapes.



The photo on the right is a pentominoes set I purchased in Shanghai, China. Each cube measures about 15mm on a side. It's a very nice set, great size, clever box with lid, and only cost about 120RMB (\$15). The manufacturer is Dr. Br@in.

If you'd like to check out some other useful links on Pentominoes, try these:

<http://www.johnrausch.com/PuzzlingWorld/index.html> A fantastic site on several types of puzzles.

<http://www.johnrausch.com/PuzzlingWorld/chap02d.htm> This takes you right to the section on pentominoes.

Has all solutions to the rectangles above (items 1,2,3,4).

<http://www.xs4all.nl/~gp/pentomino.html> Nice review.

<http://www.xs4all.nl/~gp/PolyominoSolver/Polyomino.html> Provides solvers for several configurations.

<http://www.cut-the-knot.com/> This doesn't have any pentominoes that I could find, but has lots of great info on math!

<http://www.cs.ust.hk/~philip/omino/omino.html> Wonderful tutorial on pentominoes, and great links, too!

<http://www.users.cts.com/crash/h/hindskw/pentomno.html> Here's a great link with a neat program to download and play!

<http://www.wins.uva.nl/misc/pythagoras/polyominoes.html> More great links. There is a lot out there.

<http://sue.csc.uvic.ca/~cos/inf/misc/PentInfo.html> Another good set of notes and links.

<http://godel.hws.edu/java/pent1.html> Wonderful solver for the 8 x 8 square with four 1 x 1 holes.

<http://pubweb.acns.nwu.edu/~gbuehler/index.html> Beautiful art made from pentominoes.

<http://202.220.193.10/tm/ZINC/PENTOA1.HTML> Several unusual solutions, in Japanese.

<http://lonestar.texas.net/~jenicek/pentomin/pentomin.html> An excellent site with solutions to 3D and 2D configurations!

<http://members.aol.com/KevinGong3/poly/polypage.html> The math of polyominoes.

<http://www.pentomino.be.tf/> A nice student site with additional puzzle links.

For books on pentominoes, I highly recommend the following:

Mathematical Puzzles & Diversions

Martin Gardner
LCCN 59-9501
Simon and Schuster
NY 1959

Creative Puzzles of the World

Pieter van Delft and Jack Botermans

LCCN 77-80234
ISBN 0-8109-2152-9 (pbk)
ISBN 0-8109-0765-8
Harry N. Abrams, Inc.
NY 1978

Polyominoes

Solomon W. Golomb
ISBN 0-691-02444-8 (pbk)
ISBN 0-691-08573-0
Princeton University Press
Princeton, NJ 1994

Pentominoes

Jon Millington
ISBN 0-906212-57-X (pbk)
Tarquin Publications
Norfolk, England 1995

Tilings and Patterns

B. Brunbaum and G.C. Shephard
ISBN 0-7167-1193-1
W.H. Freeman and Co.
NY 1987

For more selections, check out amazon.com for other books by Martin Gardner, pentominoes, puzzles, etc.





Experiments with electronics

Build your own Gaussmeter EXPT

A slightly more expensive Gaussmeter EXPT

This Gaussmeter can use the same Hall effect device as the one above, but what I used was a device from a different company, (a device not recommended by the manufacturer for new designs any longer since availability is not guaranteed, but they only cost \$0.89 each!), with a different sensitivity: 1.3mV/G. However, the major differences between this Gaussmeter and the one above, is that this unit will give you a positive voltage out for North poles, negative voltages out for South poles, and will read 8.00Vdc for 800Gauss (North pole), and will read -5.43Vdc for 543Gauss (South pole). In a modification described, I also added a couple of LEDs to give me a visual indication of North or South pole. There is also a circuit added so it can work with an analog meter (which only measures positive voltages). The circuitry is a little more complex, but not much. It can operate off of batteries or you can build a power supply for it.

The schematic for this is below, along with some construction details.

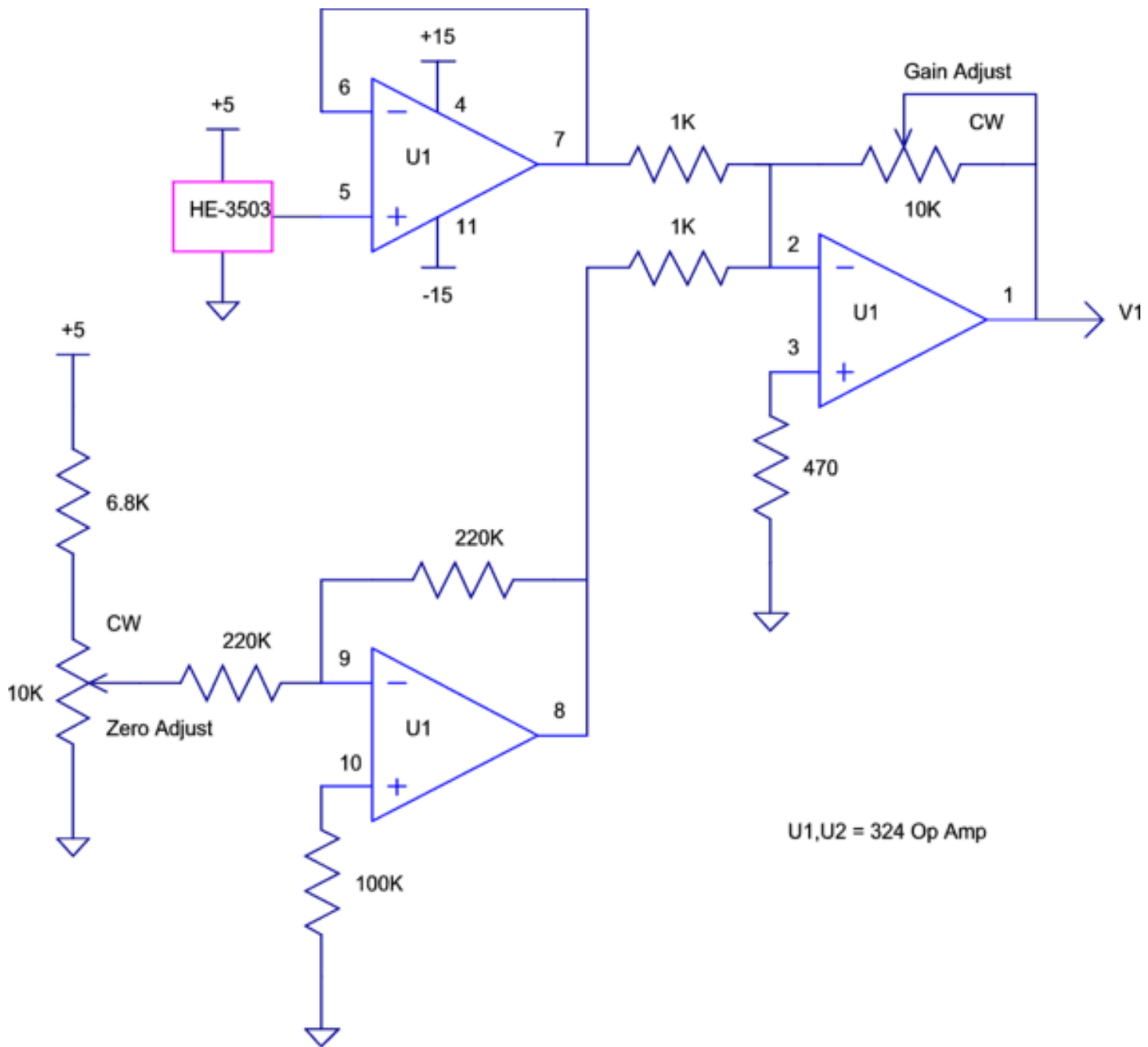

The key to the Gaussmeter is the magnetic field sensor, labeled HE3503 in the schematic above. I obtained a calibrated, analog output Hall Effect device made by [Cherry Electrical Products](#) (1-800-285-0773, in Waukegan, Illinois) but is no longer available from them. Their model number was HE503. [Allegro Microsystems](#) (508-853-5000, in Worcester, Mass) has a very similar product, model number [UGN3503](#). Check out their web sites to see what specs you may be interested in. The HE503 came with a calibration report which stated what the output of the device was at various Vcc voltages (ranging from 4.5 to 6.0Vdc) and from -1000 to 1000 Gauss. Radio Shack sells a calibrated Hall device as P/N RSU 12033684, for about \$60. It contains only the Hall device, an Allegro A3516LUA,

and nothing more except for data sheets. You would still have to build the rest of the circuit as described here if you want something useful.

It is a three lead device, where one lead is for V_{cc} , one is for common, and the third is the output. For example, at $V_{cc} = 5.000V_{dc}$, and with 0 (zero) magnetic flux, the output is $2.530V_{dc}$ (about half of the V_{cc} voltage). At -1000 Gauss (north pole), the output drops to $1.409V_{dc}$. At $+1000$ Gauss (south pole), the output rises to $3.651V_{dc}$. (This is saying that its sensitivity is $1.121mV/G$) Its non-linearity is only 0.2% and its symmetry is about 99.8% ! It even has a flat response to $23kHz$. This is a great device and costs only about $\$10!$ (The calibration report gives you the exact numbers for your particular device).

The next thing you need is a power supply which can provide $+5.00V_{dc}$ at $10ma$, $+15V_{dc}$ at $20mA$ and $-15V_{dc}$ at $20mA$. By the way, a $+12$ and $-12V_{dc}$ supply could be substituted for the $+15V_{dc}$ and $-15V_{dc}$ supply. (Check this for a [battery powered meter](#)) I had a handy little power supply from [Datel](#), their [triple output model](#), which can supply $+5.00V_{dc}$ at $500mA$, $+15V_{dc}$ at $200mA$ and $-15V_{dc}$ at $200mA$, all with $120Vac$ in. They have more efficient units available today, but this worked great. If you don't have something like this, you may need to pick up a booklet which tells you how to build one using a transformer and three voltage regulators along with a diode bridge and filter caps. The Hall Effect device draws $9mA$ typically.

The $+5.00V_{dc}$ is for the Hall Effect device and the Zero Adjustment pot circuit only. The $+15V_{dc}$ is connected to the op amp + supply, (U1 pin 4), and the $-15V_{dc}$ is connected to the op amp - supply, (U1 pin 11).

The op amp I used was a 324 quad, but a TL084 would actually work better. (Two TL082s would also work. Just be sure the - inputs and the + inputs and the outputs of the individual op amps are connected as shown, disregarding the pin numbers.) To properly finish things off, connect U1 pin 12 to common and connect U1 pin 13 to U1 pin 14.

How does the rest of the circuit work?

The circuit for the Hall Effect device is not hard to understand. I soldered the Hall Effect device to a four conductor phone cable (using only 3 of the 4 conductors) and put heat shrink tubing over the device and its leads to protect it. This allows me to be able to move it around easily. The other end of the cable is connected to $+5.00V_{dc}$, common, and an op amp, U1 pin 5, as a buffer (so the output of the Hall Effect device is not affected by the load connected to it). The output of the buffer,

U1 pin 7, is connected to a 1K resistor to the inverting input of another op amp, U1 pin 2.

In parallel with this, is the Zero Adjustment circuit. This is made up of a 10K pot (I used a 15 turn pot for easy adjustment) in series with a 6.8K resistor across the +5.00Vcc to common. This allows the output of the pot enough of a range to equal the output of the Hall Effect device at 0 Gauss. The wiper of the pot goes to an inverting op amp, U1 pin 9. The output of the inverting op amp, U1 pin 8, is connected to a 1K resistor to the inverting input of U1 pin 2. (This is the same input to which the output of the buffer op amp is connected to). The purpose of this Zero Adjustment circuit is to subtract 2.530Vdc from the Hall Effect device, so that when there is 0 Gauss present, the output of the Gaussmeter is 0Vdc.

The output of op amp U1 pin 1 amplifies the Hall Effect signal from the buffer, subtracts the Zero Adjustment voltage from it, inverts it, and amplifies the result. The output is a voltage, V1, which is positive for north magnetic poles, and negative for south magnetic poles. Its magnitude is set by the Gain Adjustment so that 1000 Gauss causes 10.00Vdc to appear on the output. The Gain Adjustment is a 15 turn 10K pot, providing a range of gain from 0 to 10. It will be set to a gain of about 8.92.

I then connect a digital voltmeter between V1 and common and simply read the polarity and magnitude of the magnetic field wherever the Hall Effect device is placed.

Here is how I calibrate the Gaussmeter.

1. Turn the Gain Adjustment fully clockwise to get maximum gain.
2. Making certain the Hall Effect device is not close to any magnets, adjust the Zero Adjustment pot to obtain 0.00Vdc out. It may end up at +0.01 or -0.02, but that's pretty close and may be acceptable.
3. Unplug the Hall Effect device from U1 pin 5 and connect the wiper of another 10K pot to that pin. The clockwise end of the pot is connected to +5.00Vcc, and the counter-clockwise end is connected to common. Using the calibration chart which came with the device to determine what the output voltage of the device would be with a 1000 Gauss field, set the pot to give that voltage on its wiper. On mine, this corresponded to 1.409Vdc.
4. Set the Gain Adjustment pot to obtain +10.00Vdc out.

- Remove the 10K pot from U1 pin 5 and replace the Hall Effect device output to it.

It is now set to measure the magnetic fields of magnets and electromagnets. Its output will be a positive voltage for a north magnetic pole, a negative voltage for a south magnetic pole, and 1.00Vdc will correspond to 100 Gauss. If the output were connected to a scope, you would also be able to see the varying magnetic field of an AC electromagnet!

Here is a table of magnetic fields and expected output voltages at various points in the circuit:

(Using the actual voltages for the device I have noted above. U1-5 means U1 pin 5)

Magnetic Field	U1-5	U1-7	U1-8	U1-1
1000 Gauss North	+1.409	+1.409	-2.530	+10.00
500 Gauss North	+1.970	+1.970	-2.530	+5.00
0 Gauss	+2.530	+2.530	-2.530	0.00
100 Gauss South	+2.642	+2.642	-2.530	-1.00
1000 Gauss South	+3.651	+3.651	-2.530	-10.00

If you have any questions or difficulty, please [let me know](#).

For other modifications to this circuit, [check here](#).

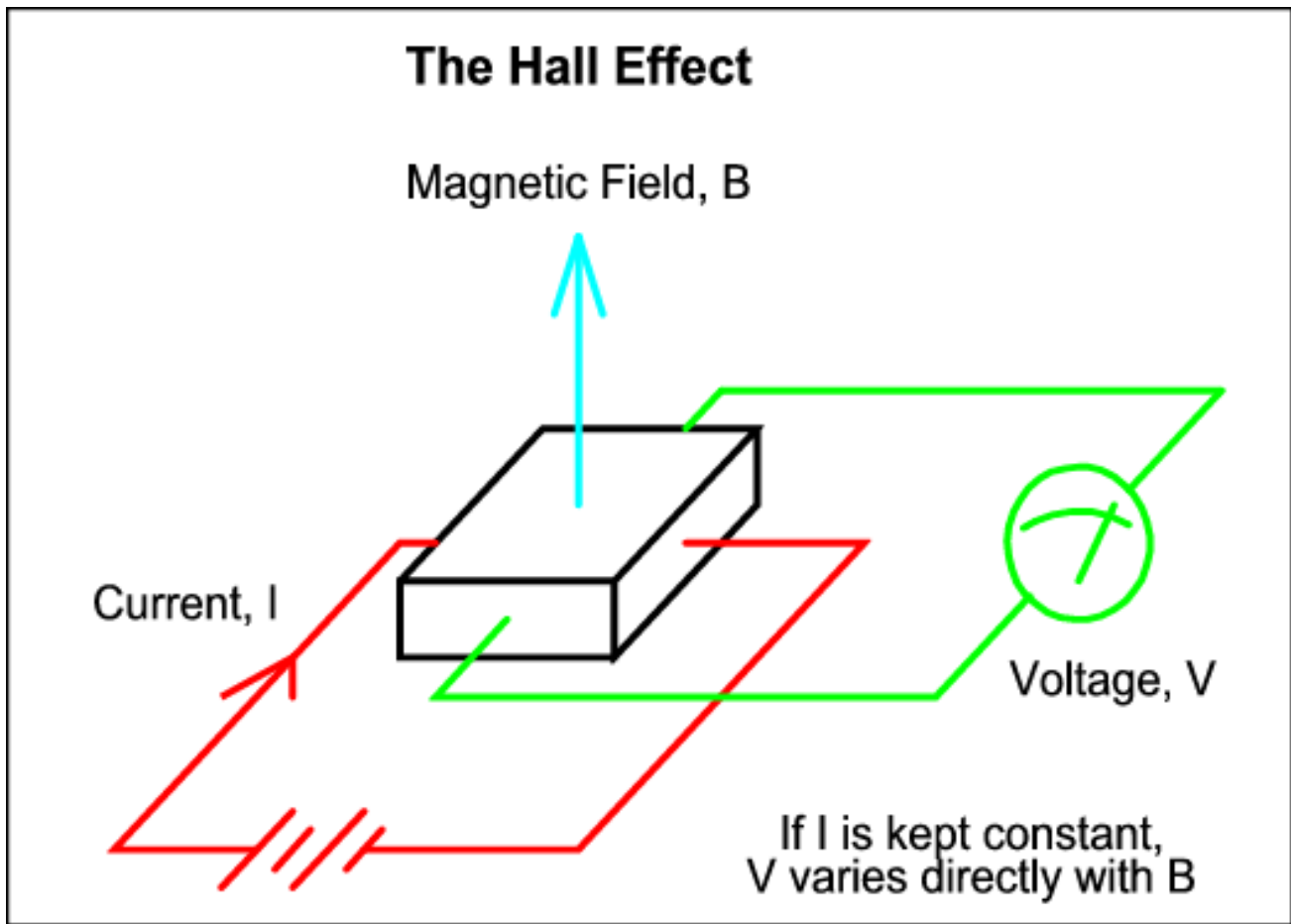

Experiments with electronics

Modifications to the Gaussmeter

Battery Powered

In order to power the Gaussmeter from a battery, a power supply similar to the one shown below will work quite well. It uses two 9v batteries, connected in series, with the common coming from between them. This is needed to make a bipolar supply. Off of the +9v side is a 5v regulator, to create the +5v needed by the Hall Effect device. The op amps are now supplied with the +9v and -9v instead of the +15v and -15v as shown on the [previous schematic](#). Everything else works the same way. However, please realize that the op amps can only output a voltage which is within 2v of the supply voltages. This means that with +9v and -9v supplying the op amps now, the maximum output voltages are about +7v (corresponding to 700 Gauss North) and -7v (corresponding to 700 Gauss South). By reducing the gain, though, you can have 1000 Gauss give you 5.00v out. Just remember to mentally multiply the output voltage V1 by 200 instead of 100 to give you the correct Gauss reading.

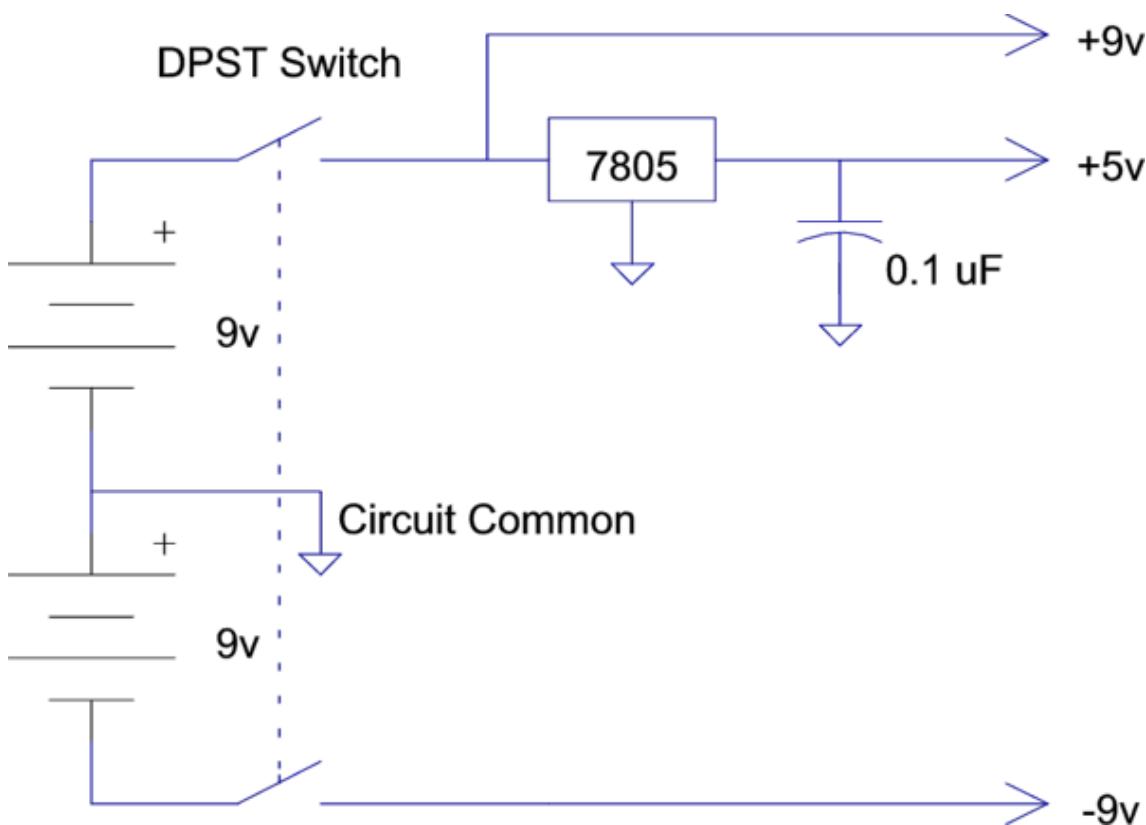

LED Indicators for North and South Poles

If you'd like to have a Red LED indicate a North magnetic pole and a Green LED indicate a South magnetic pole, here is a circuit that can be added onto the [previous schematic](#). It simply is an op amp (using one of the op amps in the quad 324 package not used in the basic Hall Effect circuit) acting as a comparator. Whenever the output voltage V1 is positive, meaning a North pole, the Red LED turns on. Whenever the output voltage V1 is negative, meaning a South pole, the Green LED turns on. There is a little hysteresis built in so that the

LED will remain in the last state until a larger opposite signal from V1 comes along. The Yellow LED simply is on whenever the power supply is on.

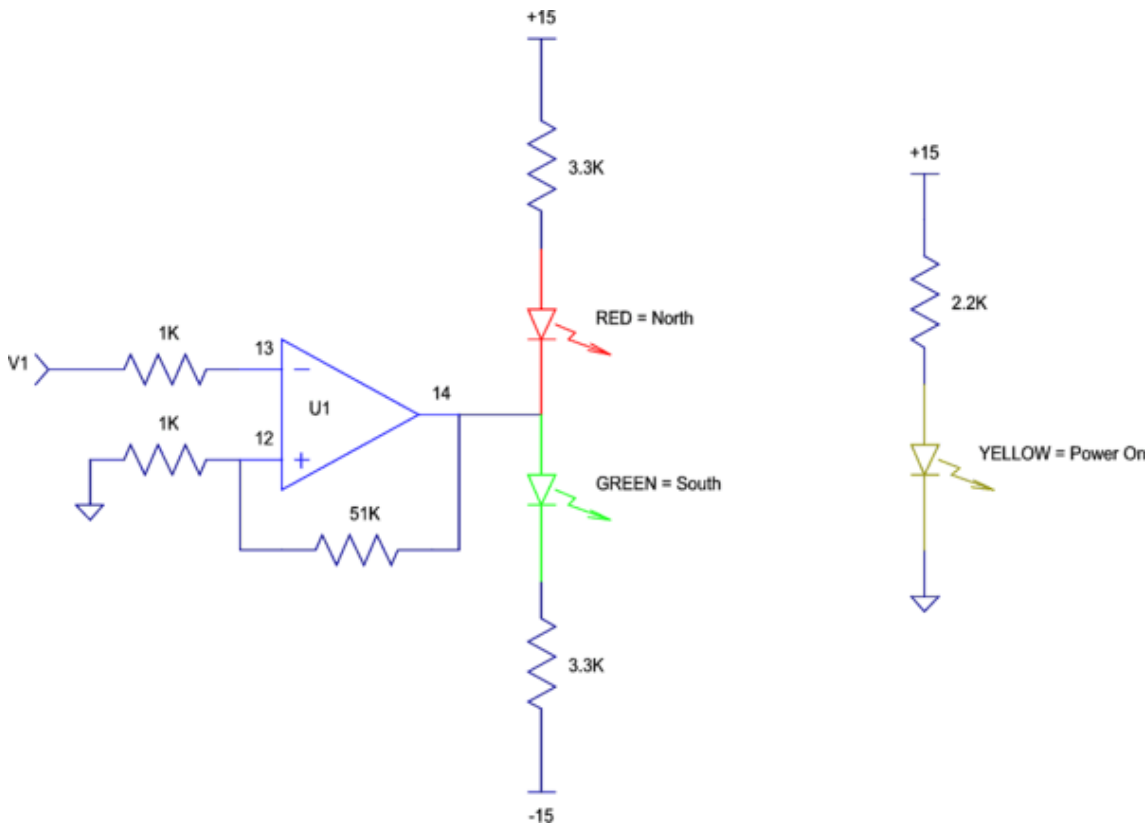

Analog Meter Output

For some applications, it is better to use an analog meter to get a better feeling for how the strength of a magnetic varies. It provides a more visual indication, rather than reading numbers off of a digital meter. For this to work properly, though, we need an absolute value circuit since most analog meters can only indicate positive voltages. The circuit below does the job pretty well. The 11v zener on the output across the meter connections is to prevent the needle of the meter from being pegged if the voltage goes over 10v. The input to this circuit is again the output V1 of the [previous schematic](#).

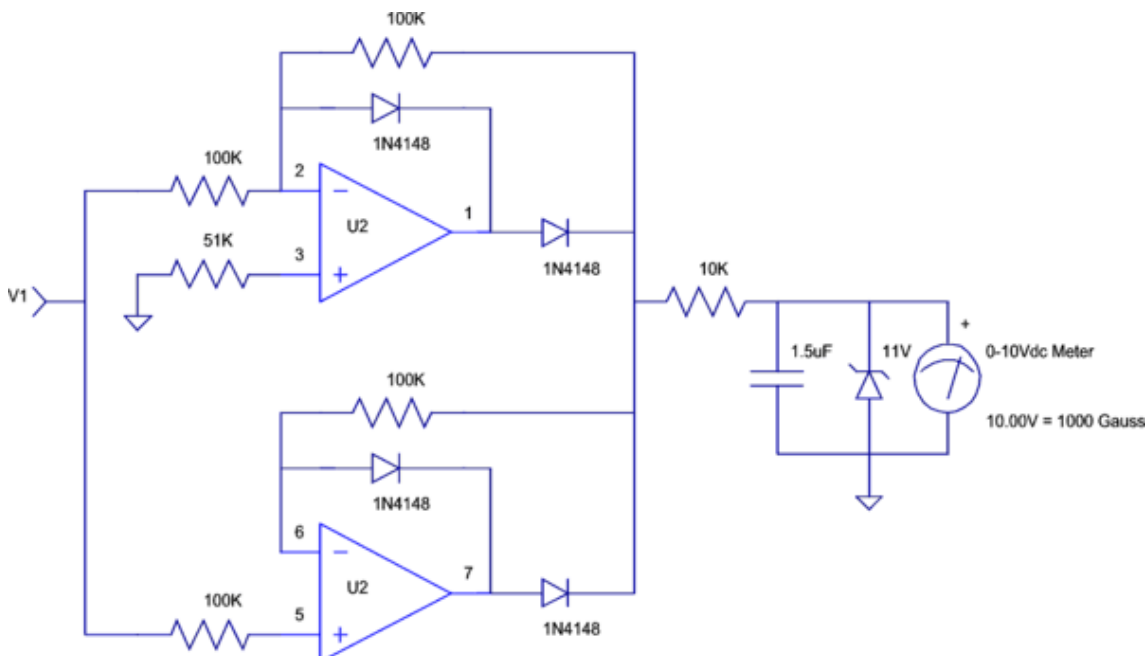

Hand-Held Battery Powered Gaussmeter and Parts List

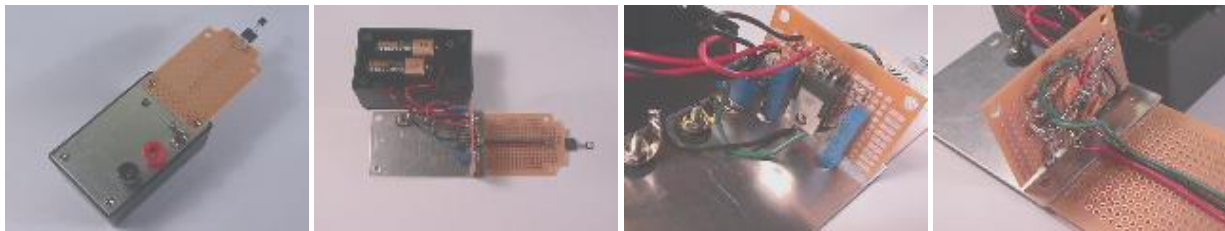

Here is a list of parts used for the basic Gaussmeter and the battery supply described above to make the hand-held Gaussmeter shown in the photos.

<u>Description</u>	<u>Qty</u>	<u>Radio Shack P/N</u>	<u>Approximate Cost, each</u>
9v Battery	2		8.99/4
Battery Clips	2	270-325	1.39/5
7805 Voltage Regulator	1	276-1770A	1.49
324 Quad Op Amp	1	276-1711	1.29
0.1uF Cap	2	272-135	0.69/2
10K, 15 turn Pot	2	271-343	1.49
Plastic Box	1	270-283A	3.99
DPDT Switch	1	275-663B	3.59
Socket for the Hall Effect	1	276-1988	1.39/3
Perf circuit board	1	276-150A	1.19
Terminal Posts for meter	2	274-661A	2.59/4
Wire, 22AWG solid	1	278-1221	4.49/3 rolls of 90' each
Resistors, 1/4w	1	271-312	7.99 for 500 piece assortment
Hall Effect Device	1	see previous page for info on source	10.00

You may want to first make sure everything works correctly using a breadboard, such as the one from Radio Shack, P/N 276-169. It costs about \$21.99, but can be used over and over for all of your new projects as well. The bundle of resistors listed above gives you a nice selection of 5% resistors to work with. If you have trouble finding any of the items, take a copy of this page and the [previous schematic](#) to a Radio Shack store and they could certainly help find the parts. The DPDT switch in the list is what I used for the DPST switch shown on the schematic for the battery supply. The second 0.1uF cap in the list was placed across the op amp terminals 4 and 11. The socket was cut so that only the three leads from the Hall Effect Device could plug in. You may want to add a 14 pin socket for the 324 op amp IC. The box I put this into is quite crowded (it's only 3-3/16 x 2-1/8 x 1-3/8"), so you may want to use a slightly bigger one. The terminals are used to plug a digital voltmeter into this to read the output voltage from V1. Radio Shack does have a little voltmeter LCD display, P/N RSU 11461498, for about \$19 which might work, but I haven't tried it.

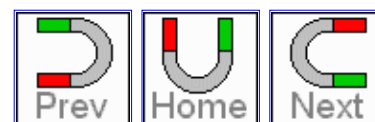



Experiments with magnets interacting with other magnets

Ball Bearing Launcher

Description:



Now, here's a neat gizmo that will surely catch the attention of anyone who sees this working. This demonstrates how magnets can be used to increase the momentum of ball bearings in order to launch one a several inches through the air. I first saw this as a [linear accelerator](#) and decided to make one to experiment with.

Construction:

This is made with very few items, that cost me less than \$5 to build! All you really need are:

- 1) three NIB magnets, about 1/2" diameter and 1/8" thick
- 2) 10 steel ball bearings, about 1/2" diameter
- 3) a piece of aluminum angle, about 1/2" on the side, and 2' to 3' long

I got all of these at American Science & Surplus. However, most hardware stores carry the ball bearings and the aluminum angle, and the NIB magnets

can be purchased from several of the suppliers I have [listed](#). If possible, the ball bearings should be just a little larger in diameter than the ball bearings.

Additional stuff you will need are some ty-raps and double-sided tape to help hold the magnets in place, and something to hold the aluminum angle rail.

First, mount a magnet onto the aluminum rail. I did this by putting a piece of double-sided tape around the edge of the magnet, put a little foam on top, and placed it about 2.5" from the end of the angle. I then ty-rapped it to hold it in place. I also made some "V" notches in two blocks of wood to use as a holder for the rail. Instead of using the blocks, you could also use a lump of clay as a holder. Then, I raised one end of the aluminum rail up by about 4" by placing some books under the right hand end to make it into a launching rail as shown here.



Demonstration:

Next, do some experimenting to see how this works under various conditions. For example, I first placed two ball bearings onto the right hand side of the magnet, and allowed one ball bearing to be attracted to the magnet from a fixed distance away on the left hand side, and measured how far the last ball bearing on the right would be launched. Then I changed the number of balls on the right hand side to one, three, four and five and repeated the experiment. Which set-up do you think would launch the ball the farthest?

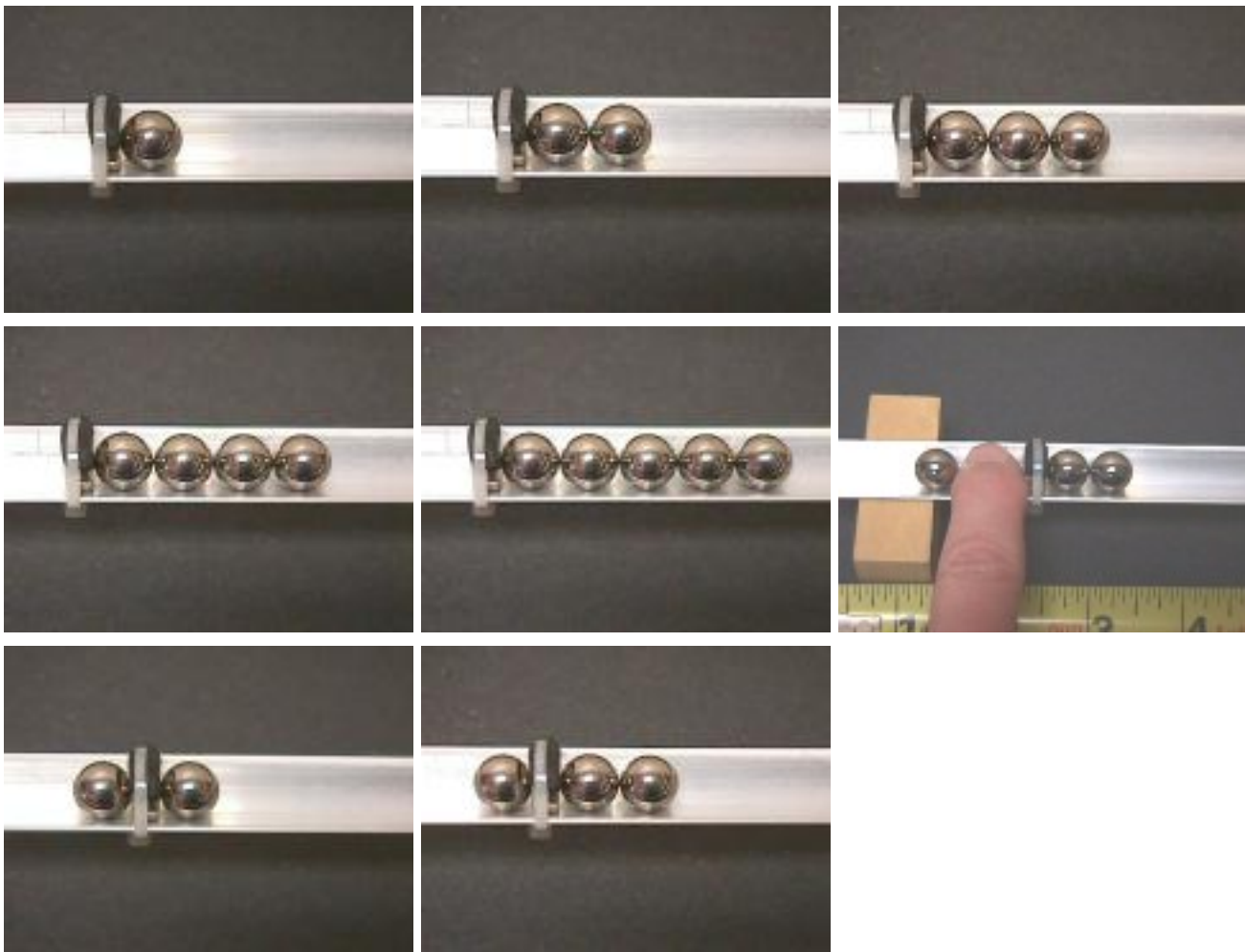

When I removed my finger as shown above, the one ball bearing on the left would be pulled toward the magnet, hit it, stick to it, and its momentum would be great enough to transfer through the balls and the magnet and launch the last ball bearing on the right hand side. (similar to "Newton's Cradle") If I started with two balls on the right, I would end up with one ball on each side of the magnet. If I started with three balls on the right, I would end up with one ball on the left and two on the right, as shown above.

Then, I made a multiple stage launcher, by fastening three magnets to the aluminum rail. The second magnet is placed 4" from the first one, and oriented so that the poles are facing the same direction - in other words, the magnets are attracted to each other. It is held in place the same way using the tape, foam and ty-rap. The third magnet is also placed 4" from the second one, and oriented the same way and fastened the same way. You should now have something like this:



Again, I would start the process with two balls on the right hand side of each magnet and measure how far the last ball on the right would be launched. I tried several combinations of number of balls on each magnet, and measured the distance of the launched ball. Here's a table of my experimental results. The rail was 4" higher on the right hand side than the left hand side, and the length of the rail was 23", so the sine of it's angle = $4/23 = 0.174$, so the angle is about 10degrees (using the arcsine(0.174) function).

Test number	# of balls on magnet 1	# of balls on magnet 2	# of balls on magnet 3	distance launched from end of rail, inches
1	0	0	1	0
2	0	0	2	10.5
3	0	0	3	12
4	0	0	4	12
5	0	0	5	12
6	0	0	6	11
7	0	2	4	19
8	0	2	3	20
9	0	3	2	20
10	0	4	2	20
11	0	3	3	22
12	2	2	2	24
13	3	3	3	24.5
14	4	4	4	25

As you can see in test #1, when there is only one ball on the right hand side of the magnet, it will not be knocked off by the ball attracted to it from the left. You will want to try some other combinations of number of balls on each magnet, as well as different launch angles, and even different distances

between the magnets! There are lots of things to try. Be sure to always keep the starting ball the same distance away from the magnet in order to have a control in your experiment. You may find that with a steep launch angle, the distance of the starting ball may need to be closer in order to be attracted and accelerated toward the magnet.

One note, since the balls really stick to the magnets, I found the best way to pull the balls off of the magnets is to slide them off sideways. When I tried to pull them off directly, the magnet would tend to be pulled out from under the ty-rap, making it a problem to fix each time I wanted to set up for an experimental run.



Conclusions:

This demonstrates how magnets can be used to increase the momentum of a steel ball bearing, from stage to stage, so that the last stage would have enough momentum to force the last ball away from the attraction it has to its magnet, and send it flying through the air.

Now, this in no way demonstrates the recovery of free energy! Each time you perform this experiment, you do the following:

- remove the balls stuck on the left hand side of the magnets
- place the desired number of balls on the right hand side of the magnets
- hold the starting ball away from the first magnet
- release the starting ball and watch the last ball fly through the air

Each time, you put more energy into the system than what you get out. Heat energy is lost from the collisions that occur between the balls and the magnets, sound energy is lost when the balls and magnets collide, energy is required to pull the ball from the magnet to set up the experiment, etc. This is very similar to setting the spring in a mouse trap, and have it trip, causing

it to launch a ball through the air like a medieval catapult. You put energy in and get some of it back out.

Using the [FREE Maxwell program](#), I plotted what the magnetic fields looked like under a few conditions. This is a great tool to help you see what's going on and better understand how designs can be improved or optimized. The conditions are where it is set up with two balls on the right hand side, where the starter ball comes along (three diagrams showing lots of field lines, very few field lines so you can see how they are complete curves, and the magnetic field strengths), and where the finish is with one ball on each side of the magnet.

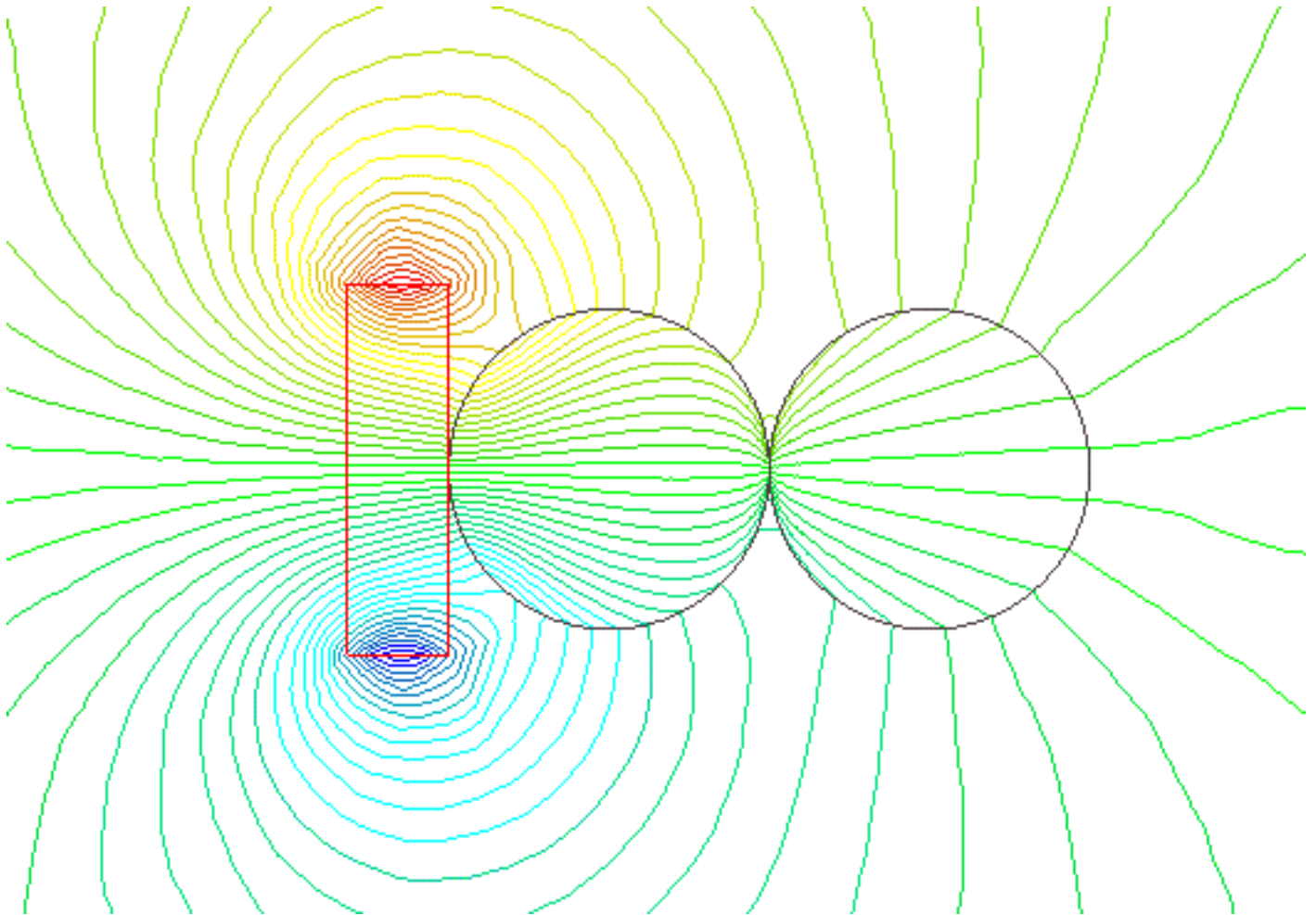

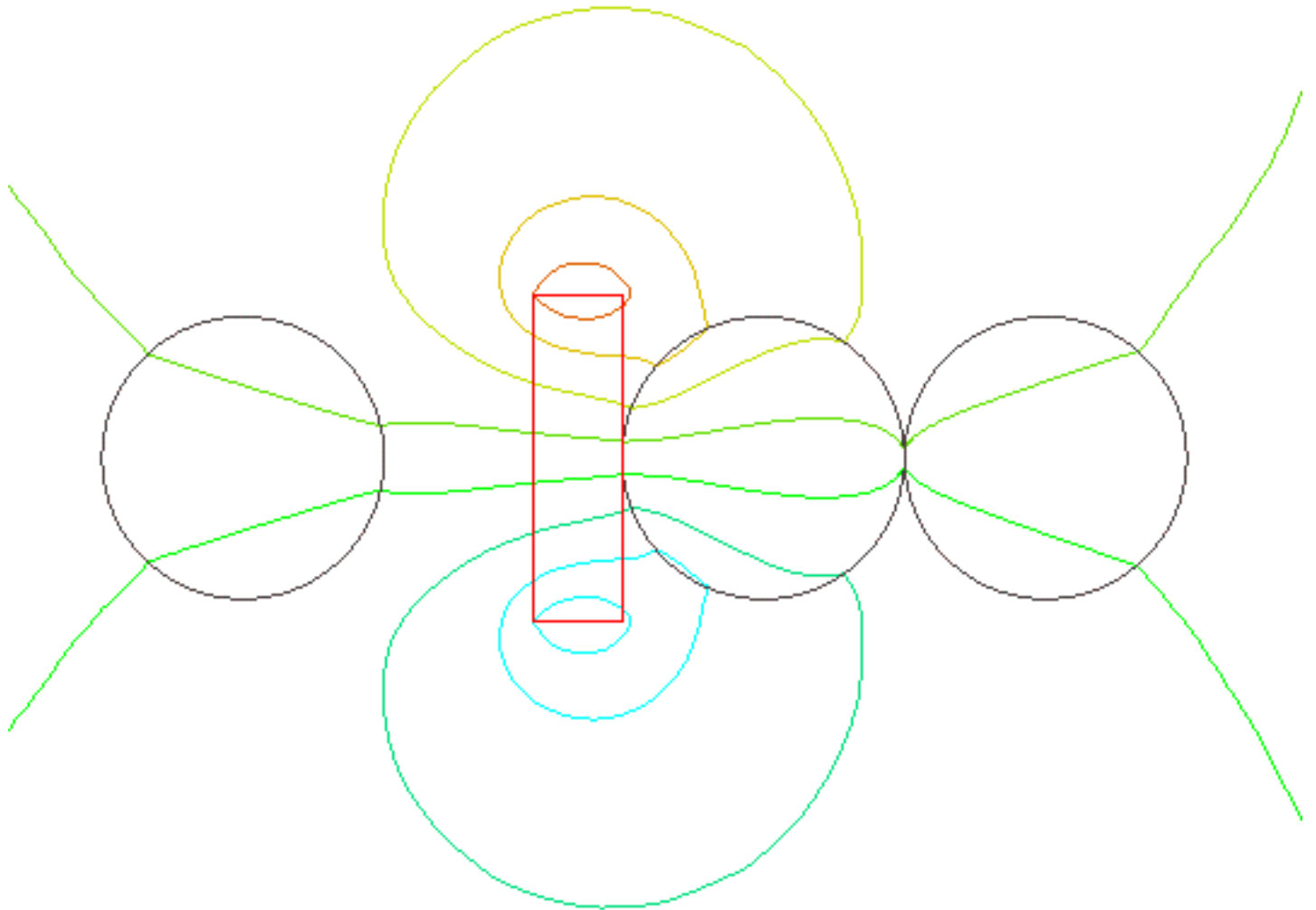
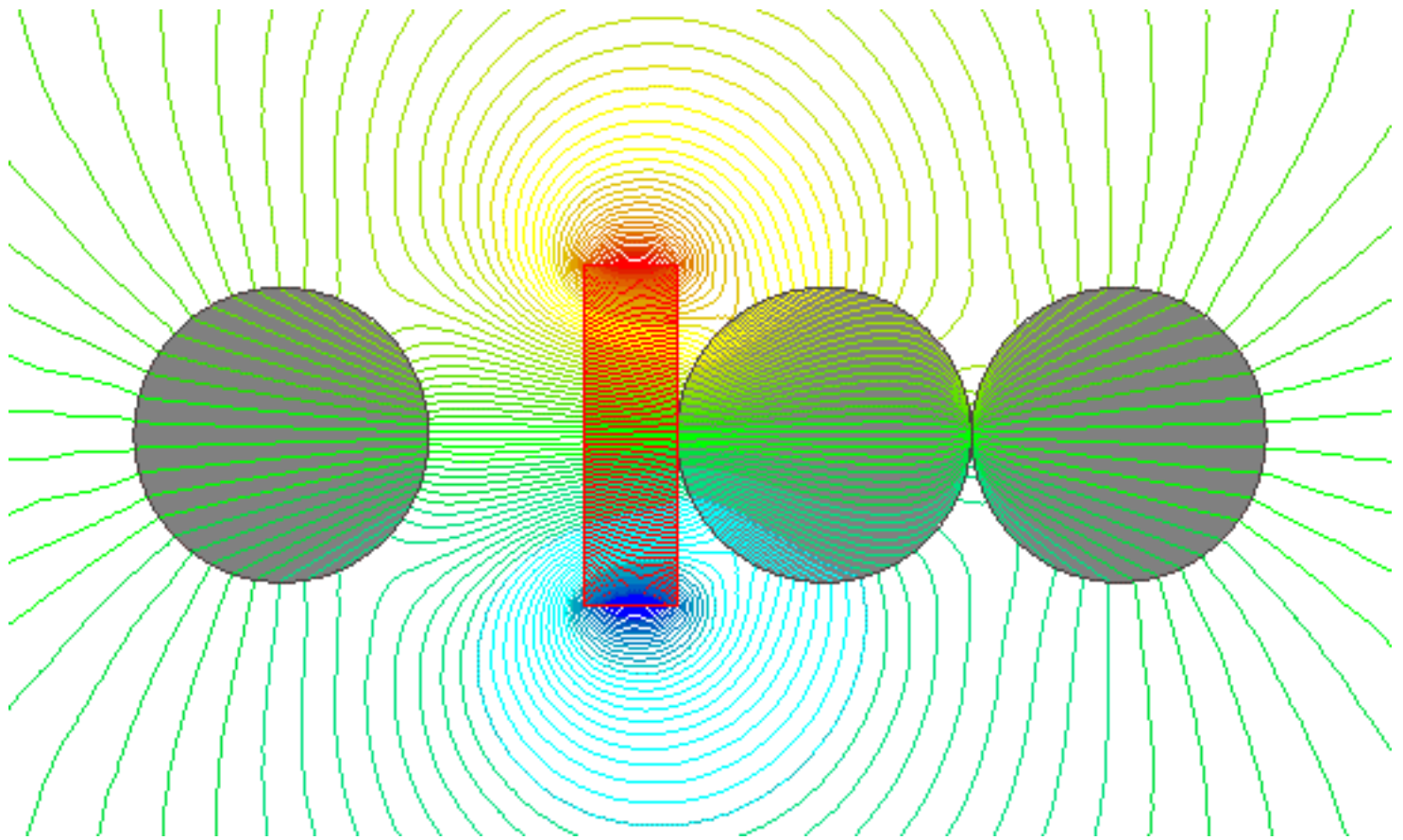

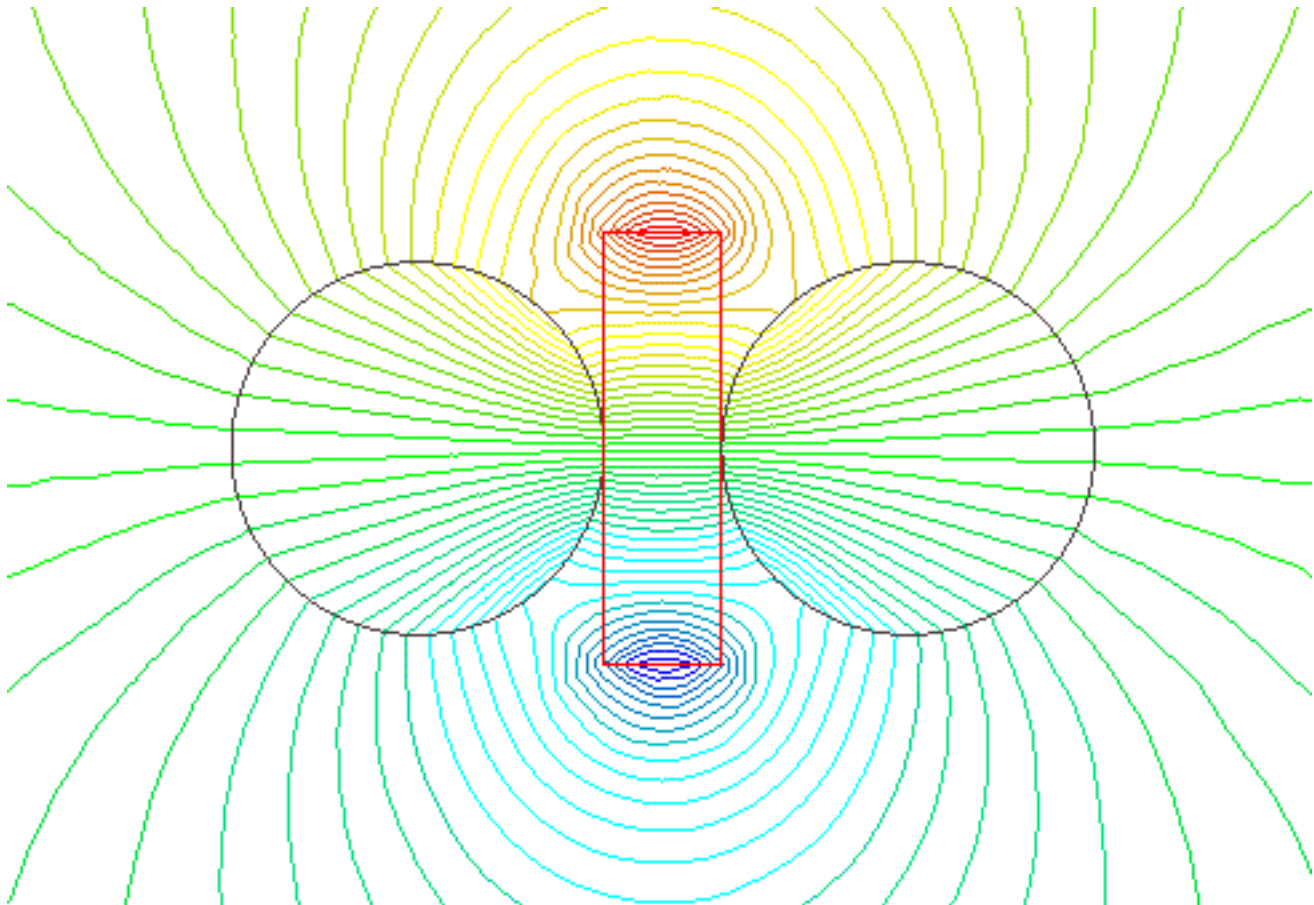
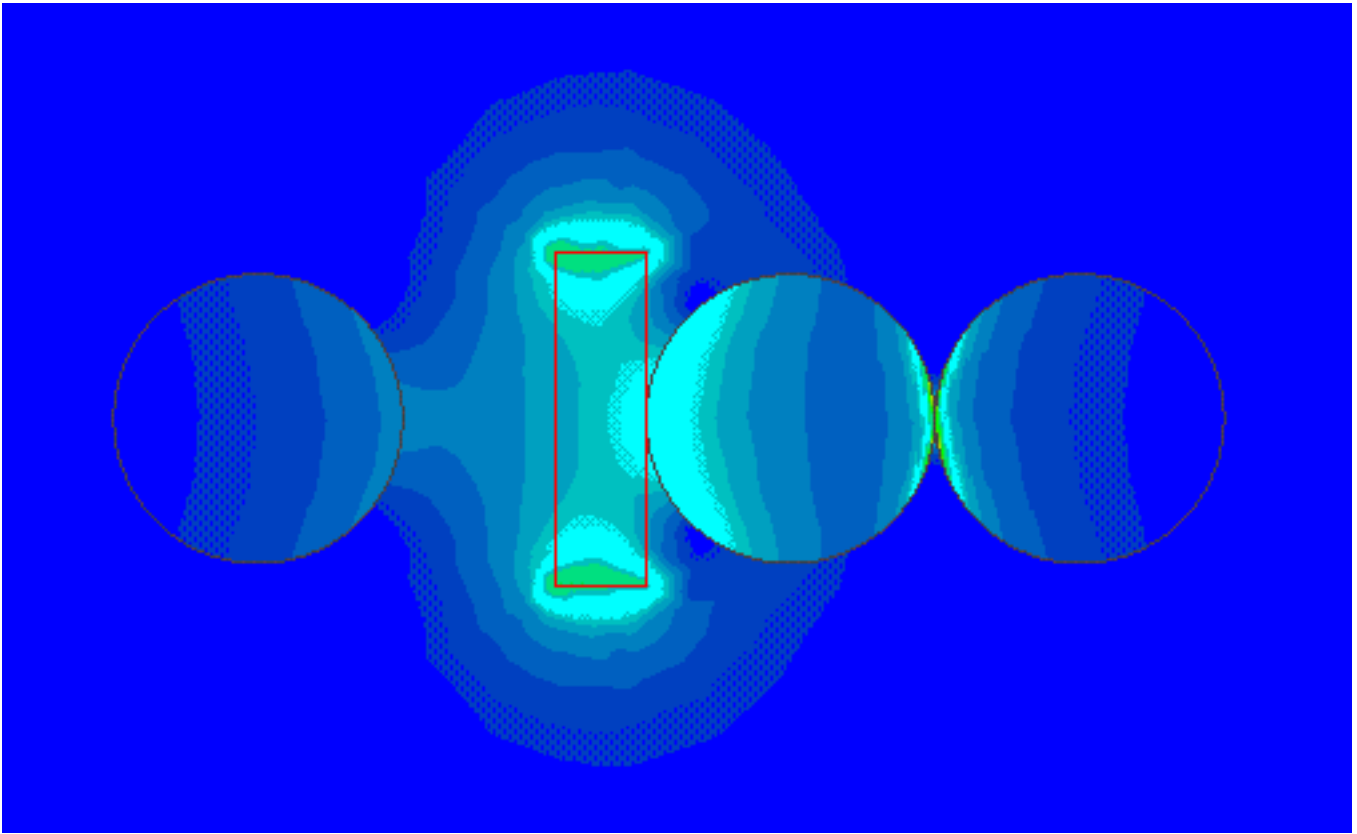





Experiments with magnets and conductors

Pendulum

Description:

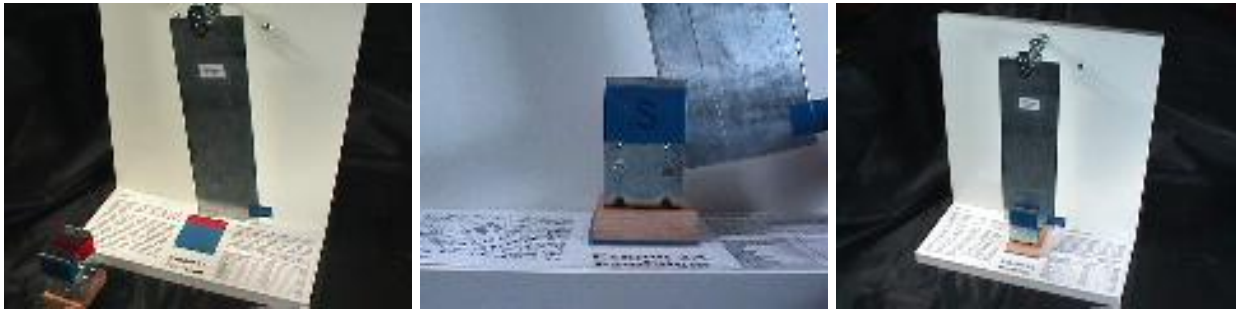

The pendulum experiment demonstrates how Eddy currents in a conductor, created by the relative motion between a magnet and the conductor (see Faraday's Law of Induction and Lenz's Law), will resist the motion of the pendulum. I wanted to see how well this works with different types of material and different thickness of the same material.

Construction: EXPT



I was able to buy different types and thickness of metal like copper, aluminum and brass, in the hardware store. They came cut in 4" by 10" pieces. I found a piece of stainless steel in my father's garage, and used a piece of silver which was purchased from a jewelry making supply store. I also found a zinc plate from a surplus supply store. I labeled each sample with the material and its thickness.

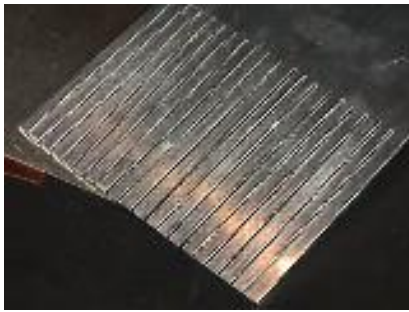

I also took an aluminum plate and cut several vertical slots in it, as shown here, to see what effect this had on the experiment. The slots were about 0.10" apart, and were about 2.5" deep. The widths of the slots were just the width of a hacksaw blade, about 1/32" thick.



I made the hinge out of a 2" 10x32 screw, two tee-nuts, two washers and four nuts. This was attached to each metal pendulum. The holes in the tee-nuts were lined up on top before the nuts were tightened.



The stationary part of the hinge is attached to the wooden back, and uses a 4" 1/4x20 screw, two tee-nuts, and two nuts. It is secured to the back with a nut and washer. The holes in these tee-nuts were lined up on the bottom.



A piece of 0.067" music wire as a pin is used to connect the two pieces of the

hinge together with very low friction. The pin went through the front bottom hole of the the larger tee-nut, through the front top hole of the smaller tee-nut on the pendulum, then through the the back top hole of the tee-nut on the pendulum, and finally through the back bottom hole of the larger tee-nut. This lets the pendulum swing freely. It also allows you to easily replace the pendulum with a different one.



The back and base of the stand are made of pressboard shelving, 11 3/4" wide, with a white laminate surface. Its dimensions are about 6" deep, 12 3/4" high and 11 3/4" wide. I added a 4" handle to the back to easily carry it around. Using this material was easy to work with since it had a nice finish to its surface. Some of the edges were also finished, but the others were kept bare after it was sawn.



The magnet is made of two Ferrite magnets attached to two L brackets on a smaller, separate, wooden base which can be moved. They were taped so if the plate hit the magnets, they wouldn't chip.

Demonstration:

Pull the pendulum plate to the side to a prescribed angle (For example 25 or 30 degrees from vertical. Mark the back board with a line to indicate this angle.) and let go of it. Use a stop watch to time how long it takes from when you let go of it to when it stops swinging. How quickly does it stop? Remove the magnet and try it again. Does it swing for a longer time? How long?

Try some other pendulums made from different types of materials and/or thickness to see how quickly they stop when they swing between the magnets.

Below is a table of the types and dimensions of the materials I used for the pendulum experiment. Please note that all of the materials used are non-magnetic.

Material	Thickness, in	Width, in	Height, in	Weight, lb
Aluminum	0.030	4	10	0.12
Aluminum	0.061	4	10	0.24
Aluminum	0.119	4	10	0.47
Aluminum with slots	0.061	4	10	0.23
Brass	0.016	4	10	0.21
Brass	0.032	4	10	0.41
Copper	0.026	4	10	0.34
Copper	0.125	2	10	0.81
Silver	0.025	4	2.5	0.09
Stainless Steel	0.020	4	9	0.20
Zinc	0.032	4	2	0.07

I made a holder out of Plexiglas for the smaller pieces of material. Ideally, each pendulum would have the same dimensions.

Experimental Question:

How does the material of a pendulum affect the ability of a magnetic field to stop its swinging?

Hypothesis:

The following criteria should cause the pendulum to stop swinging sooner:

- a. Better conducting material (higher conductivity)
- b. Thicker conductor (lower resistance)

Method:

I made pendulums out of copper, aluminum, silver, brass, zinc and stainless steel. All of these are non-magnetic and have different values for conductivity. For the aluminum, brass and copper pendulums, I have more than one thickness to see what effect that would have.

Results:

As noted above, I timed how long it would take for the pendulum to stop swinging without the magnet. I started it swinging at an angle of about 25° and stopped timing it when it would swing back and forth less than $1/8"$. Then I put the magnet in the middle and started the pendulum swinging the same way and timed how long it would take for it to stop. I then put a different pendulum on and repeated the experiment. The table below gives the results.

Material	Thickness, in	Time to stop w/o magnet, sec	Time to stop w/ magnet, sec
Aluminum	0.030	102	1.33
Aluminum	0.061	281	0.94
Aluminum	0.119	1188	0.85
Aluminum with slots	0.061	316	56.83
Brass	0.016	653	6.56
Brass	0.032	? not done yet	? not done yet
Copper	0.026	653	1.31
Copper	0.125	888	2.40
Silver	0.025	1014	1.71
Stainless Steel	0.020	299	50.34
Zinc	0.032	706	6.51

Conclusions:

For the aluminum, the thicker it is, the faster it would stop. This is because the resistance would be lower for the induced voltages, allowing higher induced currents to flow, creating stronger magnetic fields. For the fields created, the force would stop the aluminum sooner than another material because its momentum was less (due to lower density). The aluminum with slots was not affected much because the slots increased the resistance, lowering the induced current. The other materials, like brass, do not conduct as well so the induced current is less and thus take longer to stop. The copper pendulums took longer to stop than the aluminum ones because they have a lot more momentum and require a greater force to stop them swinging compared to the aluminum.

This is a simplified diagram showing the areas of attraction and repulsion in this experiment.

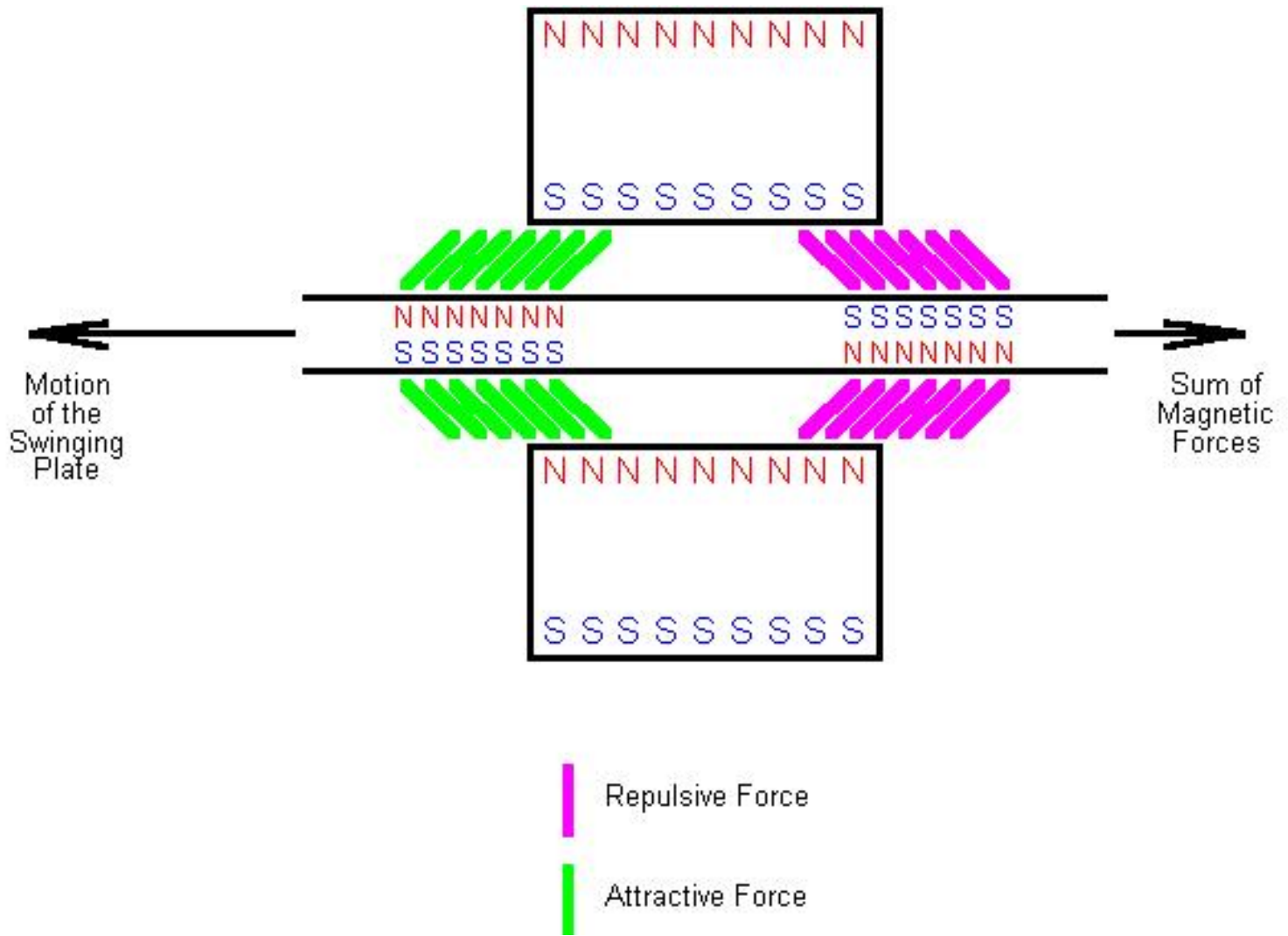



Magnet basics

Magnetism in Space

The study of the magnetism found in the planets and the sun of our solar system has been a very exciting field during the last 100 years.

Earth

Of course, trying to understand the [magnetism](#) within our own [planet](#) earth has been going on for a very long time, and only recently (within the 1990s) has a reasonable [model](#) been made which closely mimics how the magnetic field is created and how it changes over time. There are also [models](#) of the expected strength and direction of the magnetic field seen on the [surface](#) of the earth at various locations. But there is more to the [Earth's](#) magnetic field than what we can measure at various locations on its surface. There is also the effect the earth's [magnetic field](#) has on the solar wind coming from the sun. The [solar wind](#) is what the stream of particles created by the sun is called. It travels as fast as 1.7 million miles per hour (800 km/sec) and goes out in all directions from the sun! When special eruptions occur on the sun, we can measure the effects on Earth about 52 hours later. Several scientists have been studying the strength of the [magnetic field](#) of the earth out in the space around our planet, and have been able to obtain a good understanding of its [shape](#) and how it varies over time. Did you know that the [aurora borealis](#) ("Northern Lights") is caused by the [Earth's](#) magnetic field and its interaction with ionized particles? Amazing stuff, isn't it?

Sun

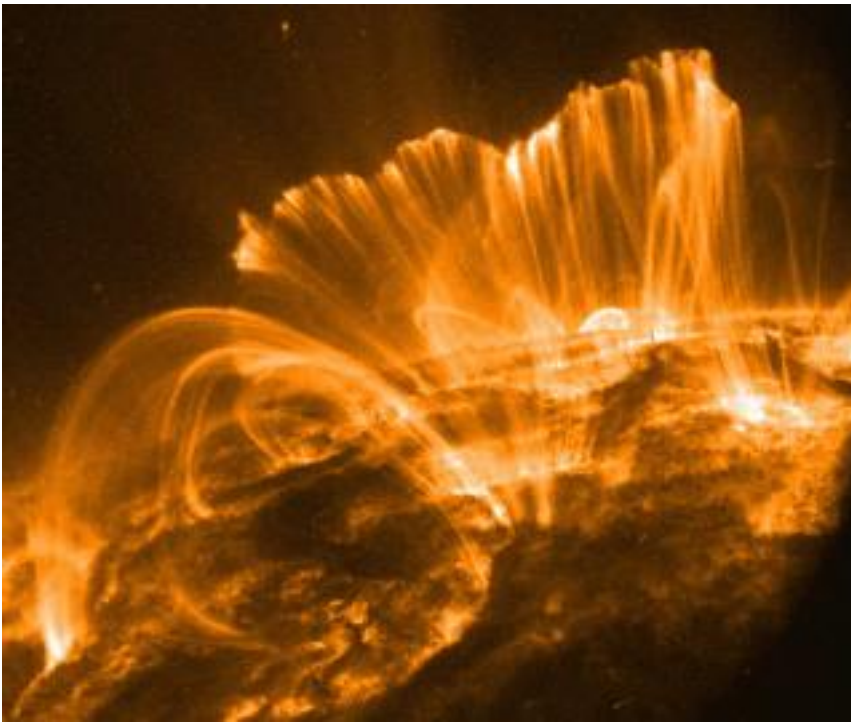

(from [Astronomy Picture of the Day](#))

Studying the [sun](#), especially the [sun spots](#) and the massive flares and eruptions happening on the [surface](#) of it, has shown that [magnetism](#) plays a [major](#) role in the life of our star. The sun goes through an 11 year cycle of sunspot activity. Actually, it's a 22 year cycle, because at the peak of the activity is when the [magnetic](#) field created within the interior of the sun [flips](#), just like the magnetic field of the earth has [flipped](#) in the past. That's what creates the sunspots, just like the odd magnetic poles that are created when the earth is partway through its field reversal. Here are some great sites which describe the studies going on. Did you realize that the scientists are able to [measure](#) the strength of the magnetic fields on the sun by carefully measuring the absorption lines seen in the color spectrum from the light from the sun, in the areas of the solar flare. When the light is exposed to a strong magnetic field, the spectrum lines will begin to split into two or more lines! The amount of the split is proportional to the strength of the [magnetic field](#). This is called the [Zeeman effect](#).

Planets

What do we know about the other [planets](#) and the moons in our solar system? Quite a bit. Most of the satellites and space probes sent out have instruments on them to measure the magnetic field in the vicinity of the

space probe. ([Arthur C. Clarke](#)'s book and movie "[2001](#)" was based on the fictional event of finding an object buried on the moon's surface. In the story, this object was found when the scientists were performing a magnetic survey of the moon's surface, and noticed a very strong anomaly at a particular location.) A close friend of mine, Herman Eckelmann, the pastor of the church I attended while at Cornell University, worked as a research associate with Frank Drake, Tom Gold and [Carl Sagan](#) at the Center for Radiophysics and Space Research. He holds a patent for one of the instruments used on satellites to [measure](#) the magnetic fields in space.

Meteorite Dust

As you know, several tons of meteorite dust falls to earth due to the debris from meteorites and micrometeorites. There are several sites that talk about ways to collect some of this dust. Most meteors have a high iron and nickel content, which makes them ferromagnetic. Check these sites out for more details:

<http://www.enchanted-treasures.com/Meteor/Micro/micro.html>

(a great site with all the info you need!)

<http://www.teachersource.com/micrometeorites.htm>

(a link from above, also very useful)

<http://www.novaspace.com/METEOR/Find.html>

<http://www.geocities.com/aerolitehunter/methunt.html>

<http://www.meteors.com/about.html>

<http://epswww.unm.edu/iom/Howto.htm>

<http://www.namnmeteors.org/meteorite-tests.html>





Experiments with magnets and our surroundings

What is attracted to magnets?

Take a wand magnet and go around the house to see what will stick to it or feel like it is attracted to it. Keep a list of the items you tried, and if the attraction was strong, weak, or none. Then try to figure out why.

Metals EXPT

Try especially different types of [metals](#), for example:

- iron and steel (nails, screws and nuts)
 - stainless steel (special hardware, some kitchen sinks, most everyday forks and spoons)
 - brass (special screws, kick-plates on front doors)
 - zinc (battery case)
 - [copper](#) (old pennies, copper pipes)
 - bronze (marine bell)
 - aluminum (foil)
 - silver (expensive silverware, some jewelry)
 - gold (wedding rings, grandma's teeth)
 - mercury (thermometer - no need to break the thermometer to do the test)
 - nickel (some coins, US nickels are made of 75% copper!, try Canadian nickels)
 - tungsten (filament in light bulb)
 - magnesium (from a science supply store, used in a ribbon form for burning in air, or from a hardware store that carries magnesium floats for working with concrete)
 - coins from several countries (try Canada, England, China, Japan, Germany)
- About the US coins, I know the following:

What is attracted to magnets?

Before 1982, the penny was 95% copper. After that, it was changed to 2.6% copper. It is mostly a zinc alloy with a copper coating.

The nickel is 75% copper.

The dime, quarter and half dollar is 91.67% copper.

The Susan B. Anthony dollar is 87.5% copper.

The new gold-colored dollar is 90% copper.

To learn more about some of these metals, check out the [pendulum experiment](#).

Below is a photo showing some of these metals, and a photo showing copper balls. (I got the copper balls from a gift shop in the UP of Michigan, at Big Springs State Park, just north of Manistique.)



Minerals EXPT

Besides seeing what effect a strong magnet has on different metals, try and find out the effect it has on different [minerals](#). A great source of minerals is found in the shops of most public, natural and science museums and in science shops or nature stores at malls. They usually have a stand with several different types of colorful minerals displayed; often the pieces are highly polished. They come with a small card describing the mineral, and cost about \$1 per item.



What is attracted to magnets?



Rose quartz

Blue lace agate

Jasper

Chalcedony



Sodalite



Tourmaline



Snowflake obsidian

Obsidian



Sodalite



Tourmaline



Snowflake obsidian

Obsidian



Bornite (Peacock ore)



Silicon



Pyrite



Galena

What is attracted to magnets?



Quartz



Tektite



Lodestone



Hematite



Bismuth



Lodestone



Tigereye



Blue calcite



Magnetite



Iceland Spar (interesting optical properties)

In particular, try minerals with iron or nickel in them. An interesting science fair project would be to

have several types of minerals on display along with a wand magnet. You can see which minerals are strongly attracted to the magnet (can be picked up by the magnet), which are slightly attracted to the magnet, and which are not attracted at all. Try to predict what category each would fall into.

Here are some minerals I know are [strongly or slightly attracted to magnets](#):

[Hematite](#)

(This is usually the very shiny, black, heavy mineral found in the displays, shown at the left in the first photo. Some jewelry is made of hematite.)

[Magnetite](#)

(This may very likely be a weak magnet by itself! Remember, this was what started the whole study of magnetism to begin with in [ancient Greece](#). This is seen in the fifth photo above.)

Lodestone (similar to magnetite, but without the cubic crystalline form)

[Franklinite](#)

[Chromite](#)

[Ilmenite](#)

[Pyrrhotite](#)

Don't forget to try [pyrite](#) (also known as "fool's gold", made of iron and sulfur), cobaltite, zincite, arsenopyrite, skutterudites, [obsidian](#) (also known as Apache Tears) and others.

To make the project more colorful and interesting, I also have some silicon, tektite, tourmaline, quartz, marble, tiger-eye, peacock ore, bismuth and others minerals. Possible selection of minerals from Edmund 81-632. Also check this site for more as a source for minerals and other interesting links:

<http://www.greatsouth.net/>

Ferrofluids EXPT

The area of ferrofluids is quite [new](#), and very [interesting](#). Ferrofluid is made of small particles (~10nm) of magnetite (Fe₃O₄) surrounded by a surfactant such as tetramethylammonium hydroxide. The surfactant is needed to keep the particles of magnetite from agglomerating (clumping together) due to magnetic and van der Waals interactions. It's like having a slippery skin around the small particle of magnetite. Thermal motion helps, but is not sufficient by itself. A group of these prepared particles is like a solution that

acts like a medium density liquid which is affected by magnetic fields. When a magnet is brought near it, the liquid splits up and starts to group itself into spikes or hairs along the magnetic field lines as shown in the photos. It is used to seal rotating shafts, and in speakers to help dampen the vibrations of the speaker coil, and help cool the coil. Great stuff to play with!

Here are some photos of what you can do with a vial of [ferrofluid](#) (I purchased the kit FF-100 from [Educational Innovations](#) as well as the separate preform display cell FF-200 sitting in front.) When storing the preform display cell, it is best to sit it onto its cap. This keeps the interior walls cleanest. Cost for the kit is about \$50. Cost for the preform cell is about \$17.

Arbor, Edmund 82-215, AS&S, EdIn FF-100, FF-200.

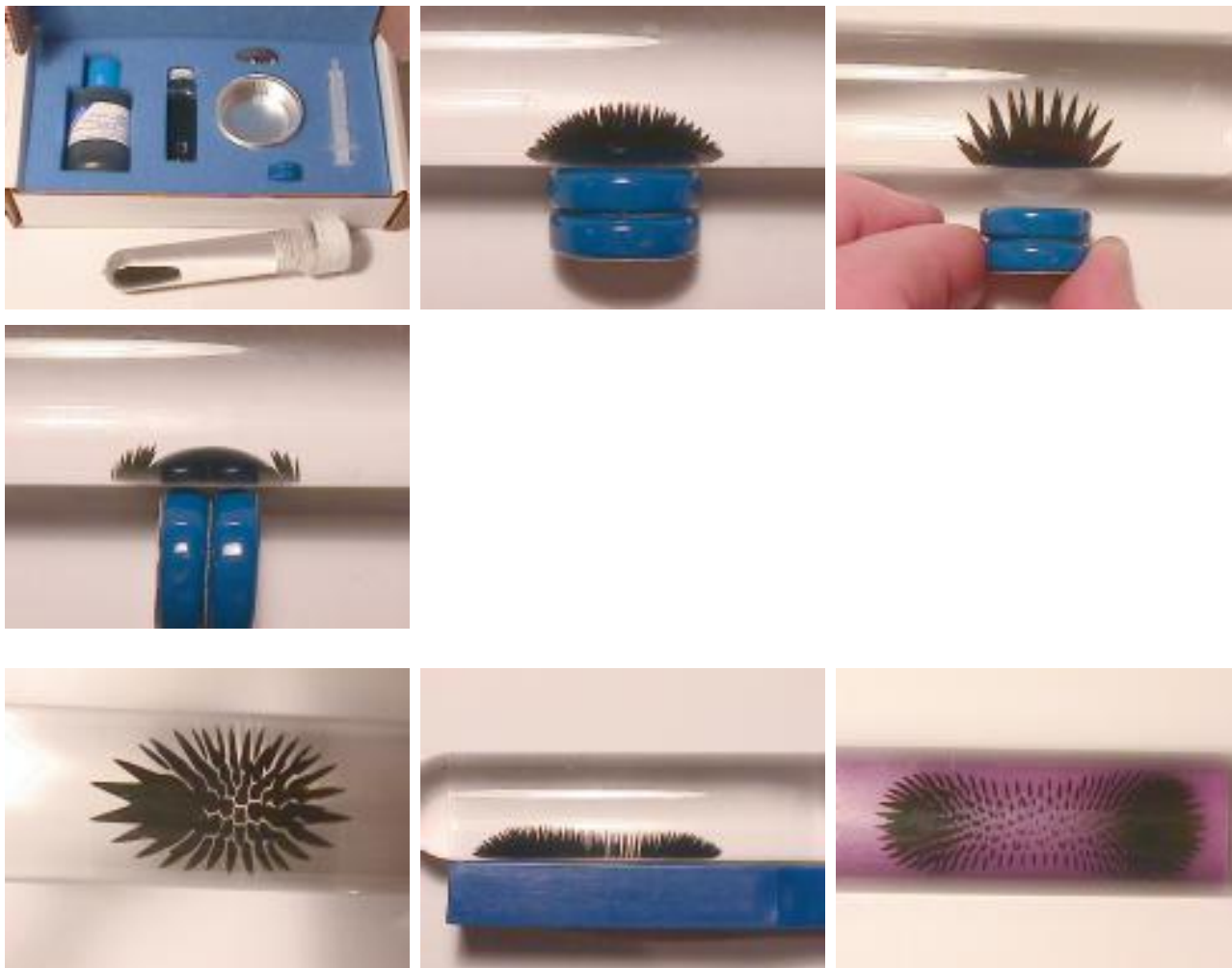

What is attracted to magnets?



Other Objects EXPT

Try other materials, too, like wood, plastic, carbon, cotton, wool, glass, concrete, leaves, CDs, and so on, which you can find around the house.



Some things which will be attracted to or stick to a very strong magnet, like a rare-earth magnet, is the tape from a VCR or audio tape, a dollar bill, and the surface of a floppy disk. The reason these items will stick to a magnet is because of the very small particles of iron used in the ink of the dollar bill, and the iron oxide (ferric oxide) used as the recording medium for the VCR and audio tapes and for the floppy disk. (Please only use a tape or disk which

you want to destroy!)

Let's try an experiment:

As you can see in the photo above, the tape from a VCR is attracted to the rare-earth magnet. The magnet will erase the information contained on that section of the VCR tape. I used a pencil to hold open the flip-top cover.

How about a dollar bill?

On the other two photos, you can see how the bill is attracted to the rare-earth magnet.

Take a crisp bill.

Fold it about 55% of the way along its length.

Lay it on a table as shown with the longer portion on the table, the shorter portion sticking up.

Bring the magnet close to the edge of the bill.

Watch the bill spring toward the magnet.

The reason for the attraction is that the ink on the bill has some iron particles in it.

To see what effect a magnet has on floppy disks:

Take a floppy disk and try these things with it. Be sure to record exactly what you do and your observations - the two most important parts of an experiment!

Be sure to try some typical refrigerator magnets (usually very weak since they can barely hold one piece of paper to the fridge door) as well as some stronger rare-earth magnets

(neodymium-iron-boron magnets which can easily hold a stack of 20 sheets to the fridge).

Also, vary how the magnet approaches the floppy disk and leaves the disk.

For example - directly toward it, perpendicular to the plane of the disk,
or across the face of the disk, in parallel to the plane of the disk.

Perhaps a quick approach and a slow approach could also be compared.

Try the top side and the bottom side of the disk.

Even try moving the magnet around in a circle on the face of the disk.

Maybe even have a floppy held to the fridge by a magnet for a week to see if time has any effect.

If you can make an AC electromagnet, that would also be a great addition for comparison.

What kind of data will you put on the disk in order to see if the data has been corrupted?

Perhaps some bitmap images would work well, with a simple pattern of black and white squares.

They are usually large files so they would cover a large part of the disk. Also, looking at the image would be a very quick and easy way to determine if any bits were changed.

Another method would be to have a large data file on the disk, and do a file compare to the original which is kept on the hard drive.

Want to try something a bit unusual? You know that several cereals claim to be "iron fortified". How do they do that? By adding some finely powdered iron (like small iron filings) in with the cereal as it is being mixed. To see this, simply do the following:

- a. Get some cereal that has a large percentage of the RDA (Recommended Dietary Allowance) for iron, and pour half a serving into a bowl.
- b. Add water (no need to waste the milk) to the cereal.
- c. Mix up the stuff so that it is a watery slurry, not very thick.

- d. Take a strong rare-earth magnet and place it into an inside-out zip-lock bag. The purpose for the bag is to keep the surface of the magnet free from iron particles which are very difficult to get off.
- e. Move the bagged magnet around in the slurry of the cereal.
- f. After a minute, take the magnet and its plastic bag out of the slurry, and examine it to see small, dark specks attached to the plastic at the magnet. This is metallic iron.
- g. Unfortunately, our bodies can not absorb metallic iron very well, so this really does not help with our intake of iron. It would be better to take a supplementary multi-vitamin/mineral pill which contains an absorbable iron. The iron is needed to help form hemoglobin, which is the pigment in red blood cells responsible for transporting oxygen.
- h. You can now turn the bag outside in and carefully remove the magnet from the zip-lock bag. This will keep the iron filings inside the bag and off the magnet.

<http://www.eecs.umich.edu/mathscience/funexperiments/agesubject/lessons/whelmer/ironcereal.html>
http://student.biology.arizona.edu/sciconn/Metals/Metals_act.html

Conclusions

What did you find out? Do you now have a fairly extensive list of things magnets can and cannot attract?

Check out this information as well:

<http://www.eskimo.com/~billb/miscon/miscon4.html#iron>

For more information on various minerals, a great source is:

The Audubon Society Field Guide to North American Rocks and Minerals
ISBN 0-394-50269-8

Another site for obtaining various minerals is:

Problem with 2 or 3 unknown rods

Suppose you are given 2 metal rods: one is a magnet, the other is made of iron. However, both of them are painted so they appear to be the same. Their weight is the same. You are in a room with no windows so you can't tell where North is located. You have no other objects with you. How will you be able to determine which rod is the magnet and which rod is iron?

Suppose you are given 3 metal rods: one is a magnet, one is made of iron, and one is made of brass. However, all of them are painted so they appear to be the same. Their weight is the same. You are in a room with no windows so you can't tell where North is located. You have no other objects with you.

How will you be able to determine which rod is the magnet, which rod is iron, and which rod is brass?

Check here for the [answer](#).



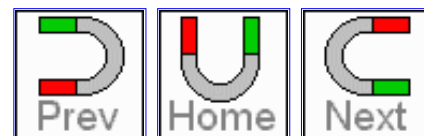

Experiments with magnets and conductors

Copper Pipes

Description:



This is an excellent demonstration of [Lenz's law](#) and eddy currents. When a magnet is dropped through a vertical copper pipe, it falls much slower than a steel ball would. Its rate of fall quickly reaches a terminal velocity and it takes much longer for it to fall out of the other end than a steel ball would take.

Construction: EXPT

There is nothing that has to be built or put together for this demonstration. All that is needed is a strong magnet (for example, a NIB measuring 1/2" diameter, about 1/8" thick) and three or four copper pipes of different sizes. The following table details the [copper pipes](#) I used:

(the air gap is the space between the magnet and the inside wall of the pipe)

(all of the pipes except for the special thick wall pipe can be obtained from most hardware stores)

(the 5th pipe in the picture is actually a red brass thick walled pipe, not as good a conductor as the copper one, number 4)

(the two thick-walled pipes were obtained from Central Wire and Steel. Cost is \$250 for a 12' piece!)

Type of Copper Pipe	Length	OD	ID	Wall Thickness	Air Gap
3/4" type L pipe	48"	0.875"	0.785	0.045"	0.143"
1/2" type M pipe	48"	0.625"	0.569	0.028"	0.035"
1/2" type L pipe	48"	0.625"	0.545	0.040"	0.023"
1/2" special thick walled pipe	48"	0.840"	0.542	0.149"	0.021"

Demonstration:

First, I call for 6 volunteers, four strong ones, one who has excellent eye-hand coordination, and one who has good hand-writing. I have each of the strong volunteers hold one of the pipes, and I

give the eye-hand volunteer a stop-watch, and I give the good hand writing volunteer a pen and paper to be a recorder. On the paper are two columns and three rows as shown below:

Pipe	Steel Ball	Magnet
1		
2		
3		
4		

This is used to record the time it takes for a steel ball and a magnet to fall from one end of the pipe to the other.

To help catch the ball or magnet as it falls out of the pipe, I place an empty plastic butter dish under each pipe, asking the volunteers to keep the bottom end of the pipe over the dish. This also helps as an audio cue as to when the object has exited the pipe, so the stop-watch person can stop the timer.



I start with the steel ball. When I say, "Ready, set, GO!" I am holding the ball at the top edge of the first pipe. On "GO!" I let go of the ball and let it fall. At that same instant, the stop-watch person starts the timer. When the ball hits the dish on the floor, the stop-watch person stops the timer. It takes a few tries to get an accurate reading. Do this a couple of times for each pipe, having the recorder note the times on the sheet of paper.



Next, I bring out the magnet. Before I do anything, I ask the audience if the magnet will take the same time, less time, or more time than the steel ball did. I then give reasons why each one may be valid. For example:

- Same time, because Galileo proved in 1600 from the Tower of Pisa that all objects fall to earth at the same rate due to gravity.
- Less time, because the earth is a big magnet and will attract the smaller magnet to it, pulling it down faster than just with gravity.
- More time, because the magnet has a flat side to it which will cause it to fall slower due to the

air resistance.

Now I hold the magnet in position, ready to drop it, and say, "Ready, set, Last time I tried this the magnet never fell out because it got stuck on the rough edge of the pipe where I cut it off. But as you can see, I removed the roughness to the edge." (This was to get the stop-watch person off balance and start timing.)

Then I say, "Ready, set, You need to be ready with the stop-watch because it may not take very long before it falls out!" (Again, the stop-watch person would have falsely started timing, keeping him on the edge of his seat.)

Finally I say, "Ready, set, GO!" and drop the magnet into pipe 1. Everyone will be surprised to see that it will take longer than the ball to fall through the pipe. We'll scratch our heads and wonder why it took so long!

Then we do the same thing with pipe 2. This will have an even more dramatic effect on the speed at which the magnet falls. Pipe 3 will be more dramatic still. Pipe 4 will seem to take forever!

Conclusion:

The times noted should be close to the following table:

Pipe	Steel Ball	Magnet
1	0.50 sec	2 sec
2	0.50 sec	9 sec
3	0.50 sec	17 sec
4	0.50 sec	36 sec

Now, what makes the difference in the time it takes to fall through the pipe?

- The distance between the magnet and the inside of the pipe wall. The closer the magnet is to the inside wall, the slower the magnet will fall.
- The thickness of the wall of the pipe. The thicker the wall, the slower the magnet will fall.

Try the same experiment with two magnets stuck together. Try it with two magnets glued North to North (it should fall slower still). Are you able to get an aluminum pipe to compare the rate of fall? Since you know the length of the pipe and how long it takes to fall through it, you can figure out its speed (terminal velocity).

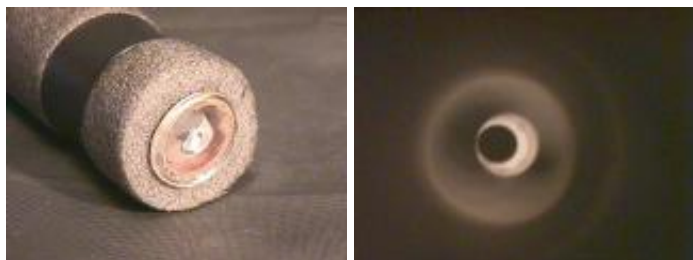

I made a handy demo unit with a 30" piece of copper pipe, glued a plexiglas window to each end

(the windows have a 1/8" hole in the middle to maintain air pressure equilibrium) with a NIB magnet inside of it. Then I taped a 6" piece of pipe foam to each end to protect the glued windows. That's the photo on the left.

The photo on the right is the view of the magnet as it drifts down the length of the pipe. Watch the magnet as it falls through the pipe. You'll see it slowly float down, moving in a small circular pattern as it falls. It's really cool!

The magnets can be obtained from Arbor P8-1123.

There is an Eddy Current Kit available showing this same effect, but not as cool, from EdIn M-200.

This is a simplified diagram showing the areas of attraction and repulsion in this experiment.

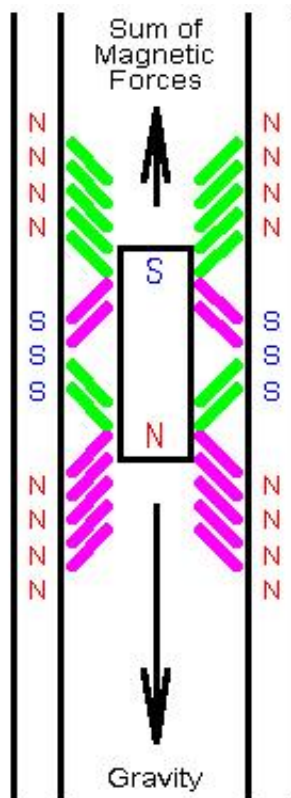

Now, I'm not 100% certain if the fields really do look this way. I used a piece of magnetic viewing film held to the outside of the copper pipe, and watched as the magnet slowly made its way down it. The magnet was only 1/8" thick. What I observed was a single transition from North to South, not two as I show in the above diagram. This certainly requires more investigation.

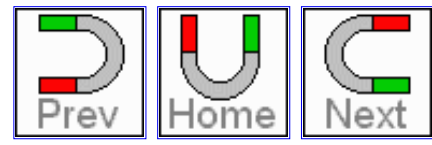



Experiments with motors

DC Motors EXPT

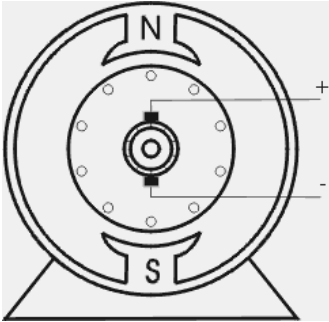

DC motors are fairly simple to understand. They are also simple to make and only require a battery or dc supply to make them run.

Here are some great sites which describe how DC motors work.

<http://www.howstuffworks.com/motor.htm>

<http://instantweb.com/o/oddparts/acsi/motortut.htm>

<http://mot-sps.com/motor/tutorial/index.html>

<http://www.members.home.net/rdoctors/> (misc motor information)

There are several types of basic DC motors you can build. They make super science fair projects.

<http://fly.hiwaay.net/~palmer/motor.html> (a simple dc motor using one battery)

<http://www.microweb.com/nature/dowss60.gif>

http://www.exploratorium.edu/snacks/stripped_down_motor.html

<http://abceducation.net/meter/elmotsetgrad.html>

<http://www.hb.quik.com/~norm/motor/>

<http://members.tripod.com/simplemotor/> (a very clever design of a dc motor with a permanent magnet armature)

<http://freeweb.pdq.net/headstrong/motor1.htm>

<http://freeweb.pdq.net/headstrong/motor2.htm>

<http://www.qkits.com/serv/qkits/diy/pages/QK77.asp>

<http://www.microweb.com/nature/dowling.html>
nicely packaged kit.

Check out the SDK200 kit for \$24. Looks like a

A DC Motor

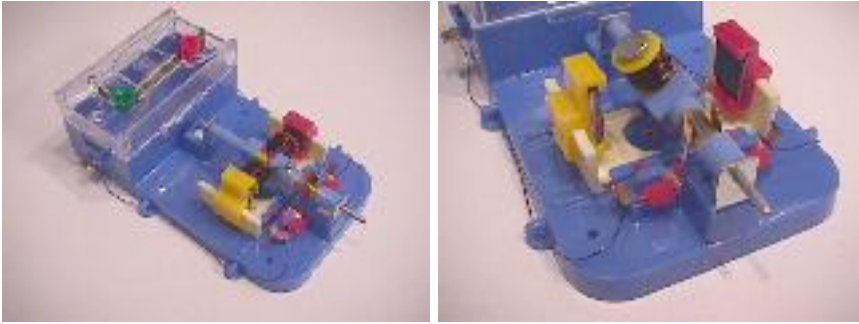

Here is a photo of a kit we put together. It works very well, and is a great demonstrator of a DC motor or a DC generator. There are several types of these kits available as noted above, as well as some very simple ones. [Edmund](#) 36-273 about \$13

A Simple DC Motor



This is my version of what others call the "World's Simplest Motor". It consists of 7.5 turns of #26 AWG magnet wire, wound onto a large Excedrin bottle, a D cell battery holder, and a couple of pieces of household wiring wires. The magnet is one of the large donuts that is available from several sources. Scrape the insulation off of the straight ends of the magnet wire where they touch the black and the white insulated wire, but only on one side of the wire's diameter. Check the links above for details. With 1.5V on it, it spins at about 800RPM! To see my version of the the world's simplest AC motor, check [this](#) out!

A Brushless DC Motor Kit



This kit is from <http://members.tripod.com/simplemotor/>. He did a great job of coming up with the idea and putting it together. This one uses the reed switch. He now has a couple more designs using hall effect devices and transistors - again very well done. The kit was easy to assemble, and works great. With 1.5V on it, it spins at about 1500RPM! (I used a calibrated strobe to measure that).

Brushless DC Motor



Most computers use brushless DC motors since they are clean (no brushes to create carbon dust or to wear out) and are now smaller and less expensive than even shaded pole AC motors. In reality, inside the hub of the motor are three sets of windings and a set of permanent magnets with sensors. As the magnets on the hub rotate past the sensors, the windings are turned on as needed to produce the torque needed. With 12V on it, it spins at about 2800RPM! Check <http://www.ebm.com/> .

Industrial DC Motors



These are cut-aways of actual DC motors, showing the field windings, commutator and the armature. You will notice that the armature laminations are skewed slightly in order to reduce the torque ripple that would normally be present. These are manufactured by Reliance Electric, part of [Rockwell Automation](#).





Experiments with electromagnets

Cool electromagnetic toys you can buy EXPT

Please note: the information at the end of each article refers to the part number of that item at the source indicated. Arbor is [Arbor Scientific](#), Edmund is [Edmund Scientific](#), AS&S is [American Science and Surplus](#), EdIn is [Educational Innovations](#).

Top Secret



This is a clever toy which shows a top spinning on a plastic base. Even after several days, it will keep on spinning. See [Patent #3783550](#). From Andrews Manufacturing. Cost is about \$11.

Arbor , Edmund , AS&S , EdIn

Space Wheel

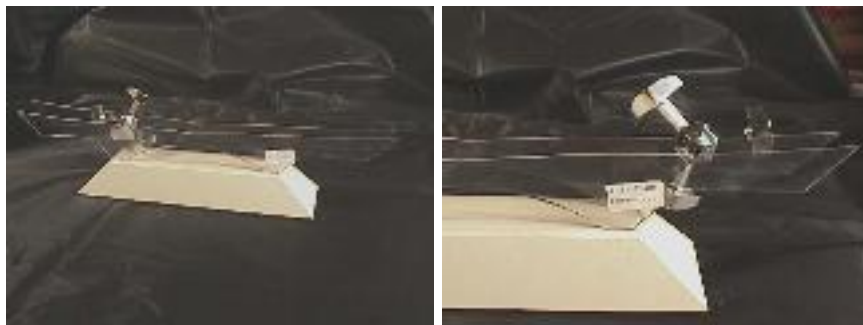

This is similar to the above toy in that spinner or wheel will continue to roll back a forth along two Plexiglas rails with a dip in them, for several days. It

makes a nice conversation piece sitting on your desk. It's very quiet in its operation. See [Patent #3783550](#). From Andrews Manufacturing. Cost is about \$20.

Arbor , Edmund 31-132, AS&S , EdIn

Kinetic Chaos



This toy shows the chaotic motions a pendulum can have if it is influenced by forces other than gravity. Makes a great toy for the executive's desk, and is silent. From Carlisle Company, 1-800-233-3931. Cost is about \$13.

Arbor , Edmund , AS&S , EdIn

Plasma Ball



This doesn't have any magnets in it, but is it affected by a magnetic field? Try it sometime! From Carlisle Company, 1-800-233-3931. Also called Nebula Ball, Sunder Ball, Lightning Ball. Cost is about \$90. Smaller one available for about \$45.

Arbor P2-7110, Edmund , AS&S , EdIn

Dynamo Flashlight

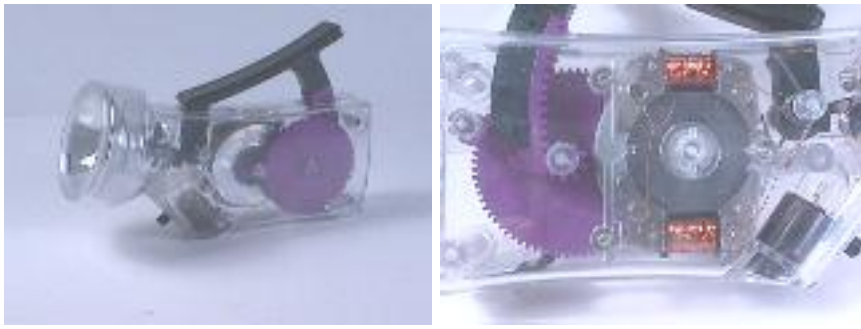

Have you ever needed a flashlight, only to find that the batteries were dead and there were no other batteries of the right size anywhere in the house? Then this is for you! It's a hand-powered flashlight! Simply squeezing the handle repeatedly (once a second or so) will keep the light on. You never need to worry about fresh batteries or leaking batteries. It even comes with a spare bulb! The case is made from clear plastic so you can see the magnetic armature rotating, generating the voltage needed for the lightbulb. From Fascinations, Seattle, WA. Cost is about \$13.

Arbor P3-3700, Edmund 81-554, AS&S 89643, EdIn SJ-200

Motion



There are several variations of this toy. The outer structure swings back and forth, causing the inner structure to start swinging in a random way. It may become annoying after a while. This costs about \$7.

Arbor , Edmund 81-198, AS&S , EdIn

Battery Operated Electromagnet



Now, this is really something to see for yourself! It is an electromagnet, made in the shape of a cup with a central core and outer rim. There is a very smooth plate which mates with it. Both the electromagnet and its plate have heavy-duty hooks attached to them. The electromagnet has places for 2 "D" cell batteries, and an alligator clip so you can power it from 1 or 2 batteries. It is supposed to be able to hold 500lbs! Amazing?! I think so! I built a stand (called "[The Plank](#)") so people can see if it can hold their weight. Imagine, a battery is able to convert chemical energy into electrical energy, the electromagnet converts the electrical energy into magnetic energy, and the magnetic energy is able to hold the plate onto the electromagnet while a 500lb person is standing on a board attached to the plate! From Science First (<http://www.sciencefirst.com/>). There are two versions: model 20-030 which can hold 200lbs with 1 D cell battery, and model 20-035 which I described above. The smaller unit is also available from Edmund Scientific. The smaller unit costs about \$48, the larger unit about \$55.

Arbor , Edmund 60-435, AS&S , EdIn

Zero-Gravity Levitator





This is a super toy! Very new (at least for me)! It was from www.unusualdevices.com for Discovery World. It stands just over 11" high, the globe is 3" in diameter, and comes with its power supply which plugs into the 120Vac wall outlet. On the back is where you plug in the power supply, there is also an on/off switch and a switch which turns on the rotating function. This will cause the globe to rotate at a rate of about once every 3 seconds. This is accomplished in a very clever way: in the base are two coils, perpendicular to each other, which has a NIB magnet on edge in their middle. When the rotating function is on, the coils cause the magnet to rotate, which in turn affects the NIB magnet which is located in the bottom of the globe, on its edge, causing the globe to rotate. On the front left of the base is an orange knob which can be rotated, adjusting the distance between the top of the globe and the bottom of the electromagnet (which is contained in the top, pointed part of the toy). There is a large NIB magnet in the top of the globe. It works very well. The globe comes apart, and an additional 1.5 ounces can be placed in the globe. More than that will cause it not to float. The only drawback is that when power is interrupted or the unit is turned off, the globe falls and hits the base. One of these times, it will break. I may need to place some padding under the globe, formed to catch and hold it if and when it falls. It costs about \$50.

Arbor , Edmund 30825-32, AS&S , EdIn





Magnet basics

What affects the strength of a magnet?

Material

As seen in the [previous section](#), and copied below, the material the permanent magnet is made from has a significant effect on the overall strength of a magnet. The material will also determine how its flux is affected by temperature, and how easily the magnet can be demagnetized by opposing magnetic fields.

There are four classes of permanent magnet materials:

- Neodymium Iron Boron (NdFeB or NIB)
- Samarium Cobalt (SmCo)
- Alnico
- Ceramic or Ferrite

This table gives us some of the special characteristics of the four classes of magnets.

Br is the measure of its residual magnetic flux density in Gauss, which is the maximum flux the magnet is able to produce. (1Gauss is like 6.45 lines/sq in)

Hc is the measure of the coercive magnetic field strength in Oersted, or the point at which the magnet becomes demagnetized by an external field. (1Oersted is like 2.02 ampere-turns/inch)

BHmax is a term of overall energy density. The higher the number, the more powerful the magnet.

Tcoef of Br is the temperature coefficient of Br in terms of % per degree Centigrade. This tells you how the magnetic flux changes with respect to temperature. -0.20 means that if the temperature increases by 100 degrees

Centigrade, its magnetic flux will decrease by 20%!

Tmax is the maximum temperature the magnet should be operated at. After the temperature drops below this value, it will still behave as it did before it reached that temperature (it is recoverable).

Tcurie is the Curie temperature at which the magnet will become demagnetized. After the temperature drops below this value, it will not behave as it did before it reached that temperature. If the magnet is heated between Tmax and Tcurie, it will recover somewhat, but not fully (it is not recoverable).

(please note that this data is from www.magnetsales.com)

Material	Br	Hc	BHmax	Tcoef of Br	Tmax	Tcurie
NdFeB	12,800	12,300	40	-0.12	150	310
SmCo	10,500	9,200	26	-0.04	300	750
Alnico	12,500	640	5.5	-0.02	540	860
Ceramic or Ferrite	3,900	3,200	3.5	-0.20	300	460

Temperature

The temperature coefficient column indicates how the magnetic flux varies with the temperature of the magnet.

Experiment EXPT

Let's do an experiment to show the effect of temperature on magnets.

The goal will be to measure the flux density of the magnet when it is at three different temperatures, and compare the measurements. Here are some ideas:

1. From the above table, you can find Tcoef of Br and Tmax for four types of permanent magnet materials for background information.
2. What would be needed to perform this test?
 - a. Select two or three magnets. They could be the same type or different types of material. I would not use SmCo or Alnico since they don't vary much with respect to temperature. Instead, I would use a Ceramic magnet, or a NdFeB (rare earth) magnet. We won't have to worry about exceeding their maximum temperatures, and their change in flux density as a function of temperature is relatively great. It is best to use two or three samples to give you better results. Contact Radio Shack at www.radioshack.com or The Magnet Source at www.magnetsource.com or Arbor

Scientific at www.arborsci.com or Edmund Scientific's at www.scientificsonline.com for the type of magnet you want.

b. Obtain a meter to measure the flux density of the magnets (Gaussmeter). This can be built from the [instructions](#) I provide, or can be purchased from The Magnet Source at www.magnetsource.com as P/N GM1A and probe GM1APT70 (about \$450 total).

What if you don't have a way to get or make a Gaussmeter? Well, you could try seeing how many tiny nails or staples or small steel ball bearings the magnet can pick up, and try to obtain a comparison of flux density from that. If the magnet can pick up and hold 22 nails, end to end, when before it could only pick up and hold 20, then you have a 10% increase in flux density. Or, instead of placing the nails end to end, see how many nails can be stuck to the magnet all over its surface. Another way to measure strength would be to place a paper clip a certain number of mm away from the magnet and see if the magnet will pull the paper clip toward itself. By measuring the mm between the magnet and the paper clip where it will pull it across the surface of a smooth table, would be a measure of its flux density. Another way would be to attach a flat headed screw to the magnet, and use a small scale to see how much pull is required to pull the screw from the magnet. More pounds of pull means more flux density. As long as you make comparisons using the same method, you should get reasonable results. If you have a bunch of small steel ball bearings (about 1/16" diameter), see how many will stick to the whole surface of the magnet when doing the test.



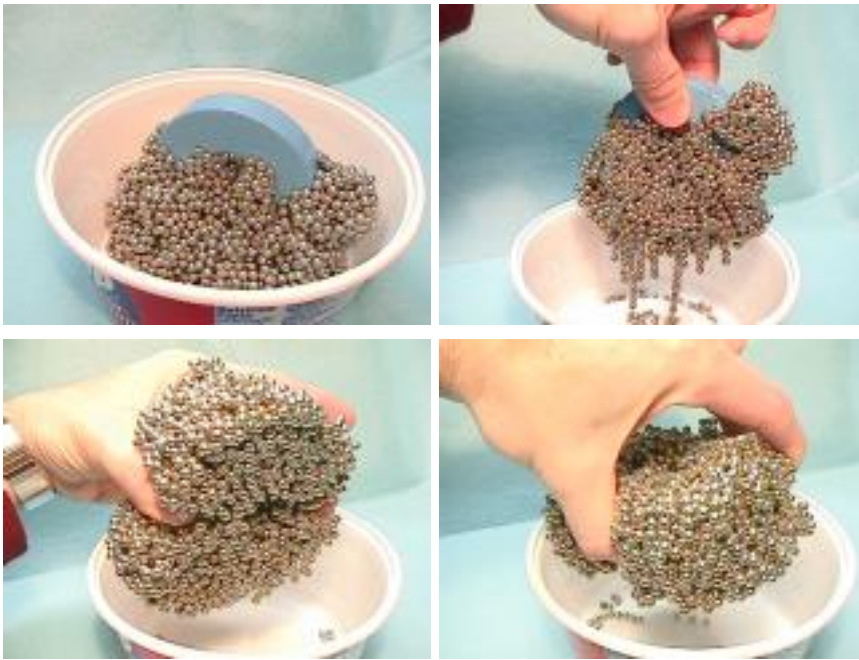

These photos show a bunch of zinc plated steel BBs (about 1/8" in diameter) I bought at a sporting goods store (about \$4 for 3000 of them!), stuck to different magnets. I had a lot of fun just playing with the magnets in the BBs. Smaller balls (like steel shot for shot-gun shells) would give you a more accurate result, but these larger ones were easier to handle.

c. Get three temperature baths ready. They don't have to be ready at the same time. The experiment can be done with hours or days or weeks in between the measurements taken in each of the three temperatures baths.

0 C is made by filling a styrofoam cup with ice and adding just enough water to cause the ice to start to float. Stir the ice water to get an even temperature. In about 10 minutes, the water will be cooled to 0 C and will stay there until all the ice is melted. Keep the magnet totally submersed in the ice water for 15 minutes before removing it to perform the flux test.

100 C is made by boiling water on a stove. When bubbles start to appear, the water is at 100 C and will stay there until all the water is evaporated. Keep the magnet totally submersed in the boiling water for 15 minutes before removing it to perform the flux test.

-196 C is made by using liquid nitrogen. This should be available from hospital supply stores. This must be handled carefully in order to prevent frost burns to the skin (see <http://sprott.physics.wisc.edu/demobook/chapter2.htm>). When an object is dipped into liquid nitrogen, a lot of bubbles will be seen. When the rapid bubbling stops, the object has reached -196 C. Keep the magnet totally submersed in the liquid nitrogen for 2 minutes after the rapid bubbling stops, before removing it to perform the flux test.

If it is too difficult to obtain liquid nitrogen, get some dry ice from a local supplier (check the yellow pages). This will be a -78 C bath. Again, handle only with gloves,

not with your bare hands! Place the magnet between two blocks of dry ice for about 15 minutes before removing it to perform the flux test.

3. Now, you will need to measure the flux density of the magnet when its temperature is at 0 degree C (temperature of freezing water).

a. This may not be super easy since the distance between the magnet and the probe measuring the flux density has a big effect on the measurement, as well as the position of the probe to the edge of the magnet. Mark one face of the magnet with a dot using a permanent marker so you measure the same pole each time. Set up a fixture to hold the magnet and probe in the same position each time a measurement is taken, insuring a fairly repeatable, reliable reading. If the magnet is too strong for the meter, place a piece of plastic or wood between them as a spacer so the meter can read a lower flux density. (Don't forget that the measurement will increase by about 24 to 40 % when it gets cold.) Call this measurement G2.

b. If you are using the ball bearing method of measuring flux density, place the magnet, using non-magnetic tweezers (plastic or brass or stainless steel), into a dish filled with the small steel ball bearings. Lift the magnet out with all of the ball bearings stuck to it, and place it into a separate bowl. When the magnet reaches a temperature you can handle, pull off the ball bearings still stuck to it and count how many were stuck to it. Call this measurement G2.

4. Then, if the temperature is increased from 0 to 100 degrees C (temperature of boiling water), the flux density (Gauss) of the magnet would be decreased, so that you would be left with approximately the following % of the flux density when originally measured at 0 degrees C:

Material	Flux density at 100 C compared to 0 C (G3/G2)
NdFeB	about 89%
SmCo	about 96%
Alnico	about 98%
Ceramic	about 83%

So, place the magnet into the boiling water and wait 15 minutes to make sure it is nice and hot. Perhaps you could shape some aluminum foil to hold the magnet in the water and lift it out with it, too. The magnet might otherwise like to stick to the metal pan. If the pan is stainless steel, the magnet may not stick to it. Check this out before you start to boil the water. Place the magnet into the same fixture you used for the 0 C measurement. Call this G3.

5. Now, if the temperature were decreased from 0 to -196 C (temperature of liquid nitrogen), the flux density of the magnet will be increased, so that you would see approximately the following % of the flux density when originally measured at 0 degrees C:

Material	Flux density at -196 C compared to 0 C (G1/G2)
NdFeB	about 124%

What affects the strength of a magnet?

SmCo	about 108%
Alnico	about 104%
Ceramic	about 140%

So, place the magnet into a styrofoam bowl and slowly pour liquid nitrogen into the bowl, covering the magnet. After about 2 minutes, the rapid boiling will stop, indicating the magnet is now at -196 C. Carefully lift the magnet out of the liquid nitrogen using plastic tweezers and place it into the same fixture used for the other measurements. Call this G1.

If dry ice is used instead of liquid nitrogen, let the magnet sit between two blocks of dry ice for 15 minutes before taking the flux measurement. Please note that the change in flux density will not be as great as with liquid nitrogen because the temperature is only -78 C instead of -196 C.

6. Great, now you have the data. Let's plot G1, G2 and G3 vs temperature for each magnet. (Another data point can be obtained by performing the flux measurement at room temperature. It would be between G2 and G3 in value since a typical room is at 72 F which is 22 C.

Then figure the temperature coefficient by taking:

$$(G3-G1)*100/(G3*(\text{change in temperature from G3 measurement to G1 measurement})) = \% \text{ per degree C}$$

For example, if G1 = 87 ball bearings at -78 C, and G3 is 61 ball bearings at 100 C, then the Tcoef =
$$(61-87)*100/(61*(100-(-78))) = (-26)*100/61*(178) = -0.239\% \text{ per degree C.}$$

Compare the shapes of the curves when you join the data points with lines for each magnet. Are they different for different materials? Do they have the same slope? Are they the same for the same materials having different shapes? Do the plots have the same slope?

7. One more thing can be done with the magnets. If the temperature is increased above the Curie Temperature, as shown in the first chart above, the magnet will lose its magnetism. When it cools, it will take on some magnetism, depending on what it is near when it cools. In order to get close to 310 C, you would need something like a propane torch used for soldering copper plumbing pipes together in houses. Boiling water is far from that, so this is not a problem. However, if you want to prove the Tcurie, try heating the magnet with a propane torch (realizing you will destroy its magnetism) and do the flux test after it cools off.

8. Write up your expectations, your experimentations, and your results for your report. For the bibliography, don't forget to note the internet references used for the data in the table in step 1, as well as this Magnet Man source. Then, drop me a line telling me how well it went and any improvements you made along the way.

Demagnetizing fields

The Hc column in the data table above indicates the strength of a magnetic field which can demagnetize a magnet. The magnet would have to be

subjected to it in an opposing or repelling manner.

Experiment **EXPT**

1. Obtain samples of ceramic magnets, alnico magnets and a NbFeB magnet. Mark the North pole on each magnet (use a compass to determine which is the N end of each magnet. Remember, the South end of the compass will point to the North pole of your magnet).
2. Measure the strength of the flux using the same method suggested above for measuring temperature affects. Write down your observations. Then check the polarity of the magnet using your compass. Write down your observations.
3. Take the NbFeB magnet and place it against the ceramic magnet, North pole against North pole. Leave it there for a day. Tape or rubber-band the magnets together to keep them in that position. Do the same thing with the alnico magnet and the NbFeB magnet the next day.
4. Measure the strength of the flux for each magnet again and note the difference. Also check its polarity. Write down your observations.
5. Now, take the NbFeB magnet and place its South pole against the marked North pole of the ceramic magnet. Leave it there for a day. Do the same thing with the alnico magnet and the NbFeB magnet the next day.
6. Again, measure the strength of the flux for each magnet and note the difference. Also check its polarity. Write down your observations.
7. You should see that the flux measurement for the NbFeB magnet does not change. However, the ceramic and alnico will change greatly. The poles of the alnico magnet may even become reversed in step 3.

Physical impact

Magnets can become demagnetized by physically hammering or dropping them when the poles of the magnet are opposite to the poles of the earth, or at right angles to the poles of the earth. Steel nails can also become magnetized when hammered when the nail is lined up with the poles of the earth.

Experiment **EXPT**

1. Take a steel rod, such as an unused pin from a door hinge or a large nail.
2. Check to see if it has any affect when a compass is brought near it. Write down your observations.
3. Line it up in the North-South direction, sitting on a piece of 2x4 wood.

What affects the strength of a magnet?

4. Hit it 50 times with a hammer.
5. Check it again to see if it has any affect on a compass. Write down your observations.
6. Turn the pin around so that it is lined up opposite to what it was in step 3.
7. Hit it 50 times with a hammer.
8. Check it again to see if it has any affect on a compass. Write down your observations.
9. Turn the pin so that it is now lined up in an East-West direction and hit it another 50 times with a hammer.
10. Check it again to see if it has any affect on a compass. Write down your observations.
11. You should see that if unmagnetized to begin with, it will become magnetized in one direction in step 5, magnetized in the opposite direction in step 8, and demagnetized in step 10.

For more information:

For more information, please check [this](#).





Experiments with magnets and conductors

Superconductor

Superconductivity was first noticed when liquid mercury was cooled to liquid Helium temperatures (4.2K) while its resistivity was being plotted. While approaching that temperature, the resistance was coming down linearly, when all of a sudden it dropped to zero Ohms! Dutch physicist Heike Kamerlingh Onnes was performing this experiment in 1911.

Since that time, other elements and combinations of elements have been shown to possess a superconducting state at various temperatures. This [table](#) shows the elements which become superconducting and the temperature at which it happens. Most research has been to find materials which are superconducting at higher temperatures. For example, the ceramics in kits you can buy become superconductors at about -186C. Using liquid nitrogen (LN2) which is at -196C, you can make that ceramic superconducting.

What is unique about a superconductor?

1. First, its resistance is really zero Ohms, nothing, nada, all gone! This means that if current were flowing in the material, it would produce no heat whatsoever.

2. Second, it will exclude any magnetic fields that come near it, like a magnetic mirror. If a north pole approaches the superconductor, the magnet will behave as though another magnet, just like itself, is approaching from the other side of the surface of the superconductor. At some distance, the magnet's north pole will start to repel the "other magnet's north pole", which is really a reflection of its own. It doesn't matter if it is a north or south pole, it will act the same way. This is the Meissner effect where a magnet will float, or levitate, above a ceramic of superconducting material.

If the magnet were sitting on the superconducting ceramic when it wasn't a superconductor, and then you started to cool the ceramic, when it becomes superconducting the magnet will start to lift up off of the ceramic and begin to levitate.

One problem, though, is that if the magnetic field of the current flowing within the superconductor becomes large enough, the ceramic will drop out of superconductivity, even if it is cold. Large magnetic fields will destroy the superconducting state. So, there is always a balance between the temperature, the magnitude of the magnetic field due to the current, and the molecular structure in determining the suitability of the superconductor for a particular application. There may be new things on the horizon, though, as indicated in this article:

<http://wings.buffalo.edu/publications/reporter/vol28/vol28n28/n4.html>

An excellent site which describes research in superconductors is at:

<http://www.physics.ubc.ca/~supercon/supercon.html>



The above photos are the kit I purchased from [Arbor Scientific](#). They have a complete kit, P8-9702, an economy kit, P8-9701, and a high density kit, P8-9715. The above is the high density kit. [Edmund Scientific](#) also has a kit, 38-169. Arbor includes some great notes and instructions with their kits. The kit is actually manufactured by Superconductive Components, Inc. at <http://www.superconductivecomp.com/>.

Another quality source for kits and information is at <http://www.futurescience.com/welcome.html>. They have an excellent site describing the history and explanation of this phenomenon, and a description on how to make your own ceramic superconductors! **EXPT**
See also <http://www2.csn.net/~donsher/>

The above kit comes with a petri dish, the two ceramics shown, and plastic (non-magnetic) tweezers. The lower density ceramic comes with a smaller NIB magnet, the higher density ceramic on the right comes with a larger NIB. The ceramics are about 1" diameter.



To carry the LN2, I have a dewar from [International Cryogenics](#) (part number IC-5D), that holds 5 liters of LN2. When full, the LN2 can last for up to 21 days in the dewar. I also have a dewar flask made of HDPE that can hold 2 liters (from [Electron Microscopy Sciences](#) as part number 62038-02, also available from [Sargent Welch](#) as part number WLS-34755-B. A 90mm x 280mm glass dewar is available from [Labglass](#) as part number LG-7681-102), and has a large mouth, making it easy to submerge objects. Remember, LN2 is very, very, very cold! Always, always wear gloves and goggles when pouring it. Here is a table of various events and the temperatures at which they happen, in Fahrenheit, Celsius, and Kelvin.

Temperatures	F	C	K
water boils	212.0	100.0	373.2
body temp	98.6	37.0	310.2
room temp	77.0	25.0	298.2
water freezes	32.0	0.0	273.2
mercury freezes	-37.8	-38.8	234.4
dry ice	-108.4	-78.0	195.2
liquid Oxygen	-297.4	-183.0	90.2
liquid Nitrogen	-320.8	-196.0	77.2
liquid Helium	-452.1	-269.0	4.2

absolute zero	-459.7	-273.2	0.0
---------------	--------	--------	-----

For this, $K = C + 273.2$
and $F = (9/5) * C + 32$

Experiment EXPT

Here are some photos of the magnets floating above the ceramics. Very cool!



This shows the lower density ceramic with a couple of different magnets floating above it. I placed a copper disk, about 5/16" by 3" diameter, in the petri dish and placed the ceramic on top of that. Another demonstration is to drop the magnet onto the copper disk, watching it float downward at a slower than usual rate, then rest on the surface of the copper disk. This is an example of eddy currents.



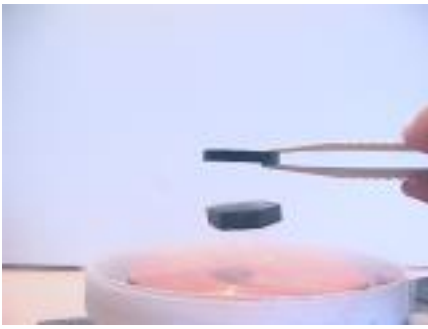

These are with the higher density ceramic, which will be suspended in the air if you lift the magnet as shown. The ceramic would also suspend the magnet under it if you flip them over. To use this ceramic, you need to have the magnet sitting on the ceramic as it cools to its superconducting state. Then pick up the magnet (the ceramic will come with it), hold it in the air for a few seconds, allowing the ceramic to warm up. As it does so, it will start to fall away from the magnet. You can then float the magnet above the ceramic, and it will be horizontal, not angled as with the other ceramic. The first photo in the next row shows that the magnet is floating about 10mm above the ceramic! This effect is called pinning, where there is some penetration of the magnetic field into the superconducting ceramic, different from the other ceramic which does not allow any penetration of the field.

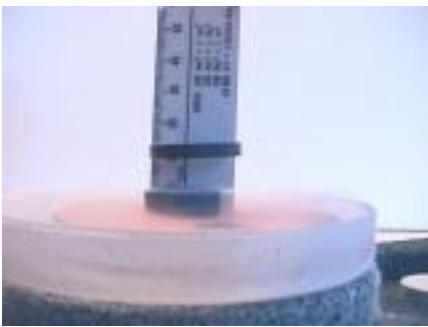

These three photos show how the fields of the magnets affect each other, even from a distance of about 15"! One magnet is floating above the high density ceramic, the other is in my hand which I rotate, causing the floating magnet to move around.



A very interesting effect I noticed was that when a small magnet was floating above the high density ceramic, it would stay in place even when the ceramic was tilted onto its edge! The next two photos show three and four steel ball bearings stuck to the magnet, floating above the high density ceramic, slowly rotating. Great effect! (I removed the copper disk for this one.)

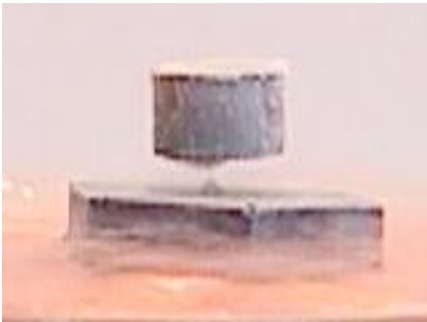

After several minutes, you will notice a liquid substance forming on the surface of the copper disk, and on the ceramic. You will also notice that when a magnet is close to that liquid, it will jump up to the magnet, then quickly evaporate! This liquid is oxygen which condenses out of the air onto the surface (same reason water condenses out of the air and onto a colder surface - like a cold glass of lemonade in the summer). Check the table above and see that oxygen becomes a liquid at a warmer temperature than liquid nitrogen. Interesting phenomenon, because liquid oxygen is paramagnetic, meaning that it is slightly attracted to stronger magnetic fields! In this photo, you can see the drop of liquid oxygen starting to form under the magnet on the ceramic, just before it jumps up to the magnet.

What good is this property of superconductivity? Here are some areas where this technology will be a help. (This information is from a display at the [Franklin Institute of Science](http://www.franklininstitute.org).)

1. Transmission of electrical power. Today, about 9% the the power generated at the electrical power stations is wasted as heat in the wires which carry it from the station to the end user. If these wires were superconductors, there would be a tremendous savings. In addition, if the generators themselves used superconducting wires, that would be an even greater amount of savings.
2. In the area of medicine, MRI (magnetic resonance imaging) machines

use powerful magnets to create the fields necessary to help physicians see into the body without having to perform surgery. Using superconductors would allow stronger magnets to be built, providing clearer pictures of various types of cells and tissues.

Another area is the production of SQUIDS which are magnetically sensitive sensors, sensitive enough to be able to detect electrical activity within the brain! They would be used to help diagnose and track changes in brain activity to determine if medicines or treatments are helping.

3. Future trains will use superconductors to provide a method to levitate the train above the tracks, reducing friction with the wheels, allowing the train to travel faster with less energy.

www.calpoly.edu/~cm/studpage/clottich/fund.html

4. If computers used superconductors, then they could be made smaller, with smaller wires which would not heat up due to resistance, which would operate faster because the computer chips are closer to each other.

Other excellent resources: <http://superconductors.org/index.htm>

<http://www.nature.com/nature/links/001130/001130-3.html>

<http://www.cryomagnetics.com/home.htm>

<http://www.owl.net.rice.edu/~hkc/superconductors/>





Experiments with motors

Motors

Electric motors are used to efficiently convert electrical energy into mechanical energy. Magnetism is the basis of their principles of operation. They use permanent magnets, electromagnets, and exploit the magnetic properties of materials in order to create these amazing machines.

There are several types of electric motors available today. The following outline gives an overview of several popular ones. There are two main classes of motors: AC and DC. AC motors require an alternating current or voltage source (like the power coming out of the wall outlets in your house) to make them work. DC motors require a direct current or voltage source (like the voltage coming out of batteries) to make them work. Universal motors can work on either type of power. Not only is the construction of the motors different, but the means used to control the speed and torque created by each of these motors also varies, although the principles of power conversion are common to both.

Motors are used just about everywhere.

In your house, there is a motor in your furnace for the blower, for the intake air, in the sump well, dehumidifier, in the kitchen in the exhaust hood above the stove, microwave fan, refrigerator compressor and cooling fan, can opener, garbage disposer, dish washer pump, clocks, computer fans, ceiling fans, and many more items! I once counted over 137 electric motors in my house.

In industry, motors are used to move, lift, rotate, accelerate, brake, lower and spin material in order to coat, paint, punch, plate, make or form steel, film, paper, tissue, aluminum, plastic and other raw materials.

They range in power ratings from less than 1/100 hp to over 100,000 hp. They rotate as slowly as 0.001 rpm to over 100,000 rpm. They range in physical size from as small as the head of a pin to the size of a locomotive engine.

What happens when a wire carrying current is within a

magnetic field?



This is the **Left Hand Rule** for motors.

The first finger points in the direction of the magnetic field (first - field), which goes from the North pole to the South pole.

The second finger points in the direction of the current in the wire (second - current).

The thumb then points in the direction the wire is thrust or pushed while in the magnetic field (thumb - torque or thrust).

So, when a wire carrying current sits perpendicular to a magnetic field, a force is created on the wire causing it to move perpendicular to the field and direction of current. The greater the current in the wire, or the greater the magnetic field, the faster the wire moves because of the greater force created. If the wire sits parallel with the magnetic field, there will be no force on the wire.

This is what Tesla exploited to make AC motors.

Experiment EXPT

Let's check this out by placing a magnet near an oscilloscope and see what happens. Remember, the trace of electrons on the scope goes from left to right, which means that conventional current is going from right to left (conventional current is opposite to the electron current). So, rotate your hand so that the current is going in the opposite direction in the wire from what is shown in the photo above, from right to left. Then, if I place a North pole near that trace of electrons, the field is going into the scope face, same direction as shown in the photo above. Therefore, the thrust will be down, since the thumb is then pointing down. A South pole would cause the trace to move in the opposite direction = up.

Let's see what we get.

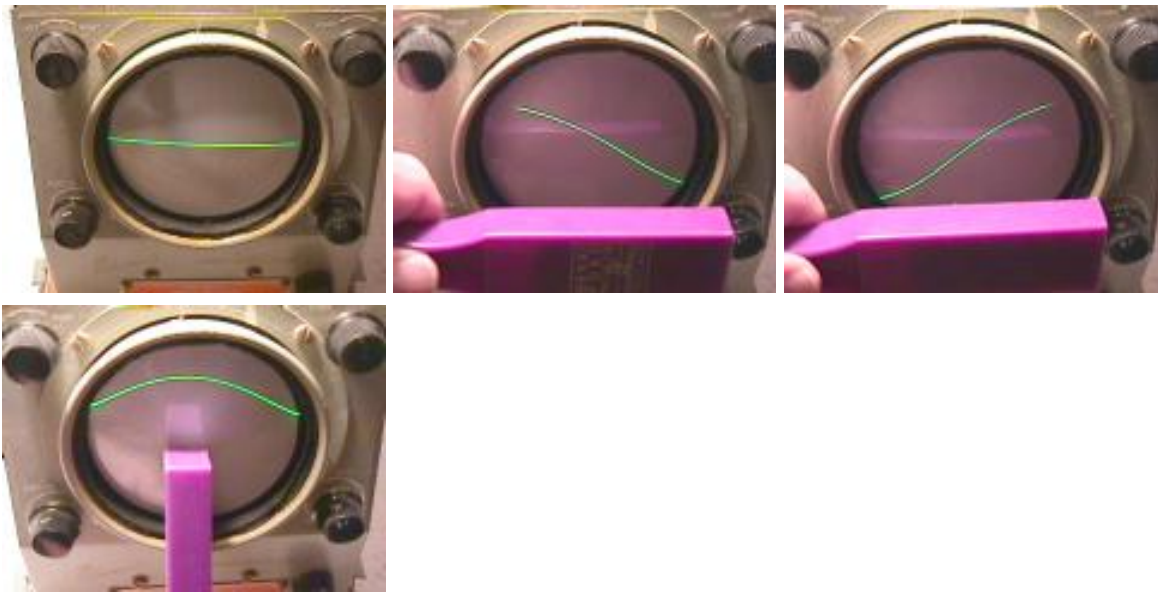

The first photo is the scope trace with no magnetic field.

The second photo is the scope trace with a North pole near it. The trace goes down like we expected from the paragraph above.

The third photo is the scope trace with a South pole near it. The trace goes up like we expected.

The fourth photo is the scope trace with a South pole on the left, causing the trace to move up, and a North pole on the right, causing the trace to move down.

Cool! Experiment matches theory!

This force on the electrons is what causes the wire carrying current in a magnetic field to want to move, which is what causes motors to rotate.

Fleming's Left Hand Rule Demo EXPT

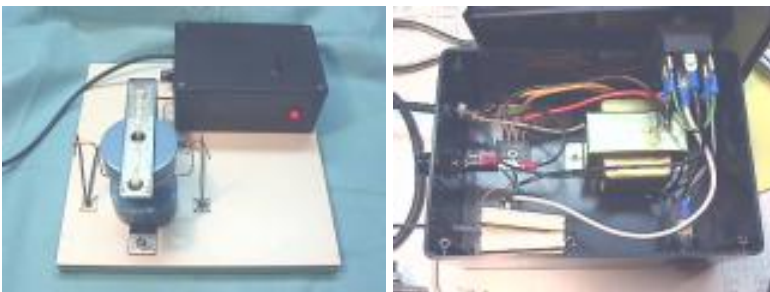

This demo shows what happens to a current carrying wire sitting in a magnetic field, supporting the Fleming Left Hand Rule. There are two large donut magnets attached to the steel brackets, bolted to the wood base. A cradle or swing made out of bare copper wire is hung between the two wire supports. The power is supplied by a 12.6Vac transformer, which is rectified and limited by four 10Ohm resistors. The switch is a momentary switch to the left and to the right, with center position off.



This first photo shows the swing with no current flowing. The second photo shows the swing moved forward due to the current flowing from right to left in the wire. The third photo shows the swing moved toward the back due to the current flowing from left to right in the wire. This reaction is used in motors and in [speakers](#).

Types of Motors

There are several types of motors used in industrial, commercial and residential applications:

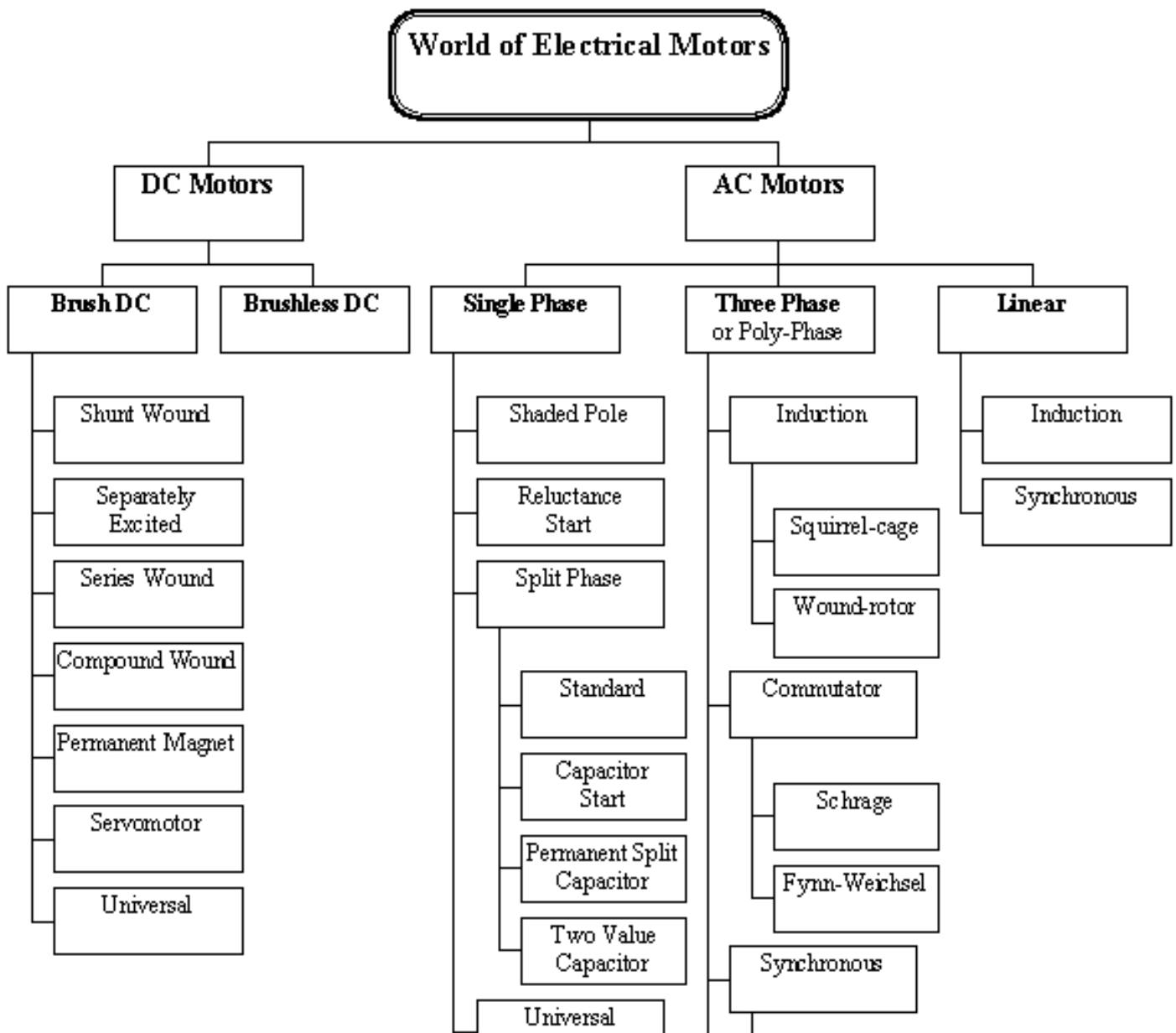

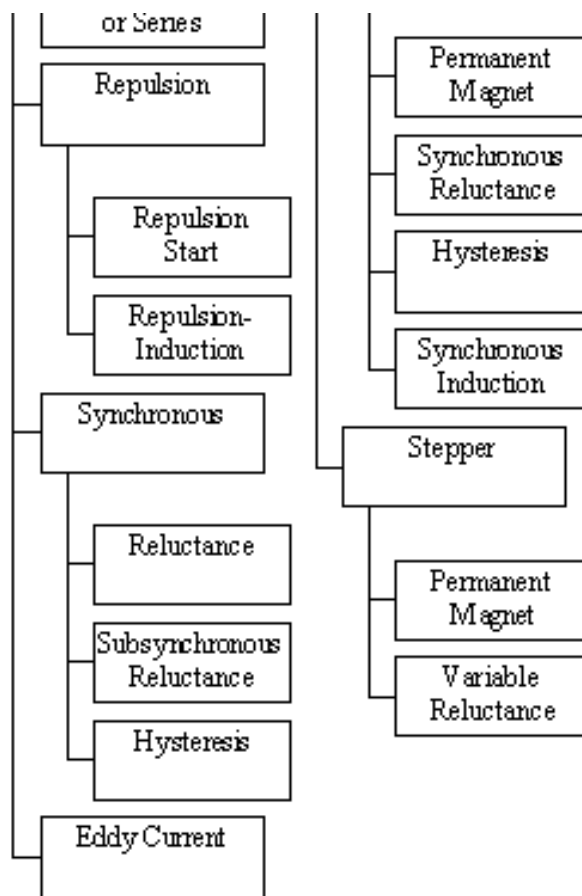

For more information, go to:

[DC motors](#)

[Universal](#)

[AC motors](#)

[Linear](#)

Not only are the motors built differently, but their speed / torque curves and load regulation curves are different from each other. This is a case of [optimizing](#) a machine for specific characteristics.

Another area of study is the control of each of these motors. The type of power electronics and control electronics needed to control the speed, torque and direction of rotation of each type of motor is unique for each one. A motor controller is often referred to as a drive. The hundreds of papers presented every year at the [Industrial Applications Society](#) of the [IEEE](#) is an indication of the amount of time spent improving the control of motors. Drives reduce the energy used by motors in fan and pump applications, and improve processes in thousand of other applications. This is a fascinating area of study and an exciting profession! (It also just happens to be my profession, too!)





Experiments with electromagnets

AC Electromagnet

Description:

An AC electromagnet is simply a coil of wire connected to an AC voltage source. It can have an air core or an iron core.

Construction: EXPT



First, you need a coil of wire wound onto a form. The coil pictured here was purchased at a surplus shop for only \$3. It can handle 30V ac or dc.



Next, you need to purchase a large bolt. This was selected to fit snugly in the coil form. The threaded portion of the bolt was sawn off with a hacksaw to get rid of the threads.



The bolt was then fit into the coil form. It extends about 2" beyond the end of the coil form.



You are now ready to go. Connect up a variac to the coil so you can control the voltage and current going to it.

Demonstration:



It can be shown how the AC electromagnet will pick up several paper clips. Next, turn the variac down to zero, to show how the paper clips fall off the end of the bolt.

Another demonstration: EXPT



In my hand is another coil of wire, with two LEDs attached back to back across the terminals (so they are in parallel with each other, but with opposite polarity). When this second coil is off of the bolt, the LEDs are off. When the second coil is placed onto the bolt, both of the LEDs light up! This is because the changing magnetic field is cutting through the wires in the second coil, creating a voltage in the second coil, which causes an alternating current to flow, lighting both of the LEDs. This is called transformer action, and demonstrates how power transformers that sit on the poles near your house operate. Transformers can increase the ac voltage or decrease the ac voltage on the secondary winding compared to the voltage fed to the primary winding of the transformer.

Conclusions:

So, it behaves like a permanent magnet as long as there is power applied to it. It's a magnet that can be turned on and off, and its magnetic strength can be varied as the voltage to it is varied.

One minor difference, though, is that the end of the bolt is changing from a North magnetic pole to a South magnetic pole and back again 60 (60Hz) times a second!

This changing magnetic field can be used to create a transformer effect.





Magnet basics

What types of magnets are there?

There are three main types of magnets:

- Permanent magnets

- Temporary magnets

- Electromagnets

Permanent Magnets

Permanent magnets are those we are most familiar with, such as the magnets hanging onto our refrigerator doors. They are permanent in the sense that once they are magnetized, they retain a level of magnetism. As we will see, different types of permanent magnets have different characteristics or properties concerning how easily they can be demagnetized, how strong they can be, how their strength varies with temperature, and so on.

Temporary Magnets

Temporary magnets are those which act like a permanent magnet when they are within a strong magnetic field, but lose their magnetism when the magnetic field disappears. Examples would be paperclips and nails and other soft iron items.

Electromagnets

An electromagnet is a tightly wound helical coil of wire, usually with an iron core, which acts like a permanent magnet when current is flowing in the wire. The strength and polarity of the magnetic field created by the electromagnet are adjustable by changing the magnitude of the current flowing through the wire and by changing the direction of the current flow.

Materials used for permanent magnets

There are four classes of permanent magnets:

Neodymium Iron Boron (NdFeB or NIB)

Samarium Cobalt (SmCo)

Alnico

Ceramic or Ferrite

This table gives us some of the special characteristics of the four classes of magnets.

Br is the measure of its residual magnetic flux density in Gauss, which is the maximum flux the magnet is able to produce. (1Gauss is like 6.45 lines/sq in)

Hc is the measure of the coercive magnetic field strength in Oersted, or the point at which the magnet becomes demagnetized by an external field. (1Oersted is like 2.02 ampere-turns/inch)

BHmax is a term of overall energy density. The higher the number, the more powerful the magnet.

Tcoef of Br is the temperature coefficient of Br in terms of % per degree Centigrade. This tells you how the magnetic flux changes with respect to temperature. -0.20 means that if the temperature increases by 100 degrees Centigrade, its magnetic flux will decrease by 20%!

Tmax is the maximum temperature the magnet should be operated at. After the temperature drops below this value, it will still behave as it did before it reached that temperature (it is recoverable). (degrees Centigrade)

Tcurie is the Curie temperature at which the magnet will become demagnetized. After the temperature drops below this value, it will not behave as it did before it reached that temperature. If the magnet is heated between Tmax and Tcurie, it will recover somewhat, but not fully (it is not recoverable). (degrees Centigrade)

(please note that this data is from www.magnetsales.com)

Material	Br	Hc	BHmax	Tcoef of Br	Tmax	Tcurie
NdFeB	12,800	12,300	40	-0.12	150	310
SmCo	10,500	9,200	26	-0.04	300	750
Alnico	12,500	640	5.5	-0.02	540	860

Ceramic or Ferrite	3,900	3,200	3.5	-0.20	300	460
---------------------------	-------	-------	-----	-------	-----	-----

Both the Neodymium Iron Boron and the Samarium Cobalt magnets are generally known as rare earth magnets since their compounds come from the rare earth or Lanthanoid series of the [periodic table](#) of the elements. They were developed in the 1970's and 1980's. As can be seen in the table, these are the strongest of the permanent magnets, and are difficult to demagnetize. However, the T_{max} for NdFeB is the lowest.

Alnico is made of a compound of **aluminum**, **nickel** and **cobalt**. Alnico magnets were first developed in the 1940's. As can be seen in the table, this magnet is least affected by temperature, but is easily demagnetized. This is the reason why bar magnets and horseshoe magnets made of alnico will easily become demagnetized by other magnets, by dropping it, and by not storing it with a keeper. Its T_{max}, though, is the highest.

Ceramic or Ferrite magnets are the most popular types of magnets available today. The flexible magnets we use are a type of ceramic magnet, with the magnetic powders fixed in a flexible binder. These were first developed in the 1960's. This is a fairly strong magnet, not as easy to demagnetize as alnico, but its magnetic strength will vary the most as its temperature changes.

Shapes

Permanent magnets can be made in most any shape imaginable. They can be made into round bars, rectangular bars, horseshoes, rings or donuts, disks, rectangles, multi-fingered rings, and other custom shapes. Some are cast into a mold and require grinding to achieve final dimensions. Others start as a powder which is pressed into a mold or pressure bonded or sintered.

Here are some of the common types available for performing your experiments.

What types of magnets are there?



This is a small disk NIB magnet, about 0.50" diameter, 0.125" thick.

Arbor P8-1123, Edmund 35-105, AS&S , EdIn



This is a very small disk NIB magnet, about 3/16" diameter, 1/32" thick, used for magnetic earrings.

Arbor, Ednumd, AS&S, EdIn

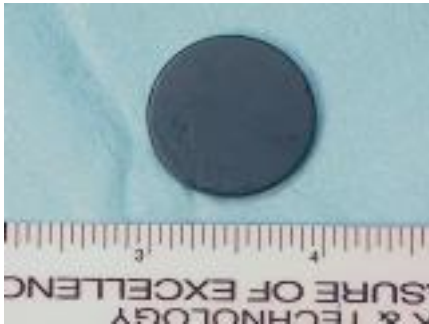

This is a larger disk NIB magnet, about 1" diameter, 0.25" thick.

Arbor , Edmund 35-107, AS&S , EdIn



This is a small donut or ring ceramic magnet, about 1.25" OD, 0.375" ID, 0.125" thick.

Arbor , Edmund , AS&S , EdIn

What types of magnets are there?



This is a large donut or ring ceramic magnet, about 2.75" OD, 1.125" ID, 0.50" thick. These have a lot of pull!

Arbor , Edmund 37-621, AS&S , EdIn



This is a kidney shaped NIB magnet, about 7/8" by 0.50", 0.10" thick.

Arbor , Edmund , AS&S 29079, EdIn M-150



This is a trapezoidal shaped NIB magnet, about 1.25" by 0.75", 0.375" thick. These are very powerful!

Arbor , Edmund , AS&S , EdIn M-100



These are several marble magnets, each about 0.5" diameter.

Arbor P8-1122, Edmund 34-968, AS&S , EdIn M-620

What types of magnets are there?



This is a wand ceramic magnet. They are quite strong, great for experimenting.

Arbor P8-1165, Edmund , AS&S , EdIn M-510



This is a real alnico cow magnet.

Arbor , Edmund 31-101, AS&S , EdIn M-400



magnet.

Arbor , Edmund 52-490, AS&S , EdIn M-450



This is an alnico horseshoe magnet. Please note the keeper on the end of the magnet, which helps to prevent the magnet from becoming demagnetized.

Arbor , Edmund , AS&S , EdIn

What types of magnets are there?



This is a long, narrow bar magnet.

Arbor , Edmund , AS&S , EdIn



This is a slightly flexible ceramic or ferrite disk magnet. Not very strong, but not likely to chip, either.

Arbor , Edmund , AS&S , EdIn

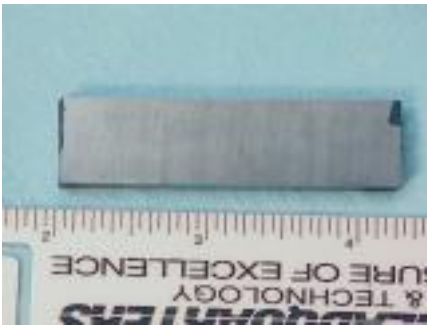

This is a ferrite bar magnet. Quite strong.

Arbor , Edmund , AS&S , EdIn

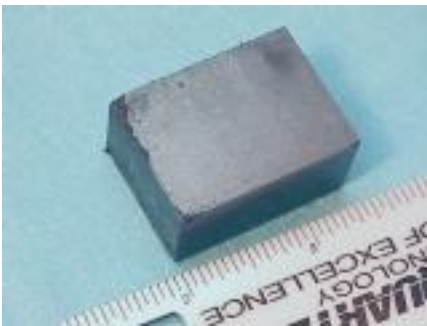

This is another ferrite bar magnet, actually, more like a block or brick! On both of these ferrite magnets, you can see little chips missing along the edges. This happens when they are allowed to come together quickly.

Arbor , Edmund , AS&S , EdIn

What does the inside of a magnet look like?

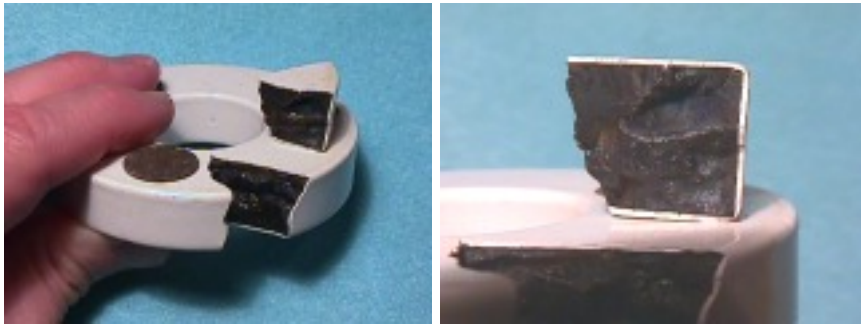

That's a great question! I have a donut or ring magnet that broke when it was dropped. I tried to glue it together with superglue, but I didn't put all of the pieces together at the same time, and now I can not fit the last piece in. (A broken bar magnet is easy to stick together while the glue is drying. Ring magnets don't want to stay together. Can you figure out why? A clue is in the magnetic field diagram shown [here](#).) So, now you can see what the inside looks like in the picture. The outside has a white epoxy coating. The inside is a simple dark grey or medium grey color, depending on what material it is made of. This was a ferrite magnet, so it is a dark grey color. By the way, the brownish circle on the magnet near my fingers is a felt pad I used to help prevent the magnet from crashing into another one. It didn't help much, did it? If the magnet isn't painted or coated, the inside looks just like the outside.

Magnetization configurations EXPT

How the magnet is magnetized is as important as its shape. For example, a ring magnet can be magnetized where N is on the inside and S on the outside, or N is on one edge and S on the opposite edge, or N is on the top side and S on the bottom side, or multiple N and S poles all around the outside edge, etc. A big help in visualizing how a magnet may be magnetized is by using a [magnetic viewing film](#). Obtain one of these viewing cards, and look at the magnets you have around your house. Make a sketch of what each magnet looks like under the viewing film. You will be surprised by some.

For more information:

For more information, please check [this](#) internal link.





Magnet basics

What is near the Geographic North Pole, a Magnetic North or a Magnetic South?

We know two things:

1. If we allow a bar magnet to swing freely on a string, the end that points towards the geographic north pole is called the north seeking pole of the magnet, and is labeled "N" since it is the North magnetic pole of the magnet. Its opposite end is labeled "S" for South magnetic pole. This is the convention used to determine the "N" or North end of a magnet.
2. We know that like poles repel each other and unlike poles attract each other.

Therefore:

The magnetic field created by the molten core of the earth must have a magnetic South pole near the geographic north pole in order to attract the "N" end of our bar magnet and compass needles. This pole near the geographic north pole is sometimes called the geomagnetic north pole.

Experiment EXPT



Try this out! Stick four NIB magnets together with a kite string between the

middle two. Let it swing freely. It will eventually line up north to south. Label the end pointing north with a small sticker or by printing "N" onto it.



Now, take a compass. Bring it close to the NIB magnets. Which end will the compass point to? The end opposite the "N" which is the south magnetic pole. Pictured are a few different compasses available. There's the ball compass, which can be pinned to your shirt or jacket. Very handy for hiking in the woods. It is always up (like those eyeballs that stare at you as you roll it across a table). Then there is the lensatic compass with a wire and mirror for more precise direction determination. Today there is also GPS units that act as compasses pointing to the true north geographic pole. There are also electronic versions of compasses with an LCD readout, as found in cars and Radio Shack.

Therefore the earth's south magnetic pole is located near the geographic north pole and is called the geomagnetic north pole. (However, we sometimes mistakenly call it the magnetic north pole because the north pole of our magnets point to it. Confusing, isn't it? Kind of like electron current flow and conventional current flow!)

Here are great links on this topic:

<http://www.ngdc.noaa.gov/seg/potfld/faggeom.shtml> (check out the link to "offset" in the first paragraph)

<http://www.sciam.com/askexpert/geology/geology6.html>

<http://www.igpp.lanl.gov/Geodynamo.html>

<http://www.eskimo.com/~billb/miscon/miscon4.html#north>

<http://fatin.koeri.boun.edu.tr/geomagnt/MAGENG/earth.htm>

[Polarity of a Magnet](#)

Flip-flopping Poles

Did you realize that the [magnetic field](#) of the earth has switched several times in the past hundreds of thousands of years? This was first discovered by sampling the cooled lava or magma which flows up out of the [mid-Atlantic ridge](#) and slowly pushes North America and Europe apart. When the magma cooled, it retained the magnetic field in which it was immersed (like magnetizing a magnet). Samplings of the magma showed an alternating pattern of residual magnetism. The samples taken closest to the ridge shows a magnetic field for the earth where our compass points to the north, like it does today. A little further away from the ridge shows a magnetic field opposite to the first, where our compass would point to the south! A little further still, and the magnetic field changed again, where our compass would point to the north!

For several years, this was a real mystery! First, how does the earth create its magnetic field. How can hot, molten iron (which is basically what the earth's outer core is made of) create a magnetic field? Normally, iron by itself does not create a magnetic field. In addition, if iron did have a magnetic field, when it is very hot (when it reaches its Curie Temperature, even before it becomes molten), it would lose its magnetism because the molecules would be knocking around so hard there is no way the magnetic domains could remain lined up. Secondly, why does the magnetic field [flip-flop](#) every 100,000 to 200,000 years?

Only recently, was a reasonable model created which explained both of these mysteries. It's called the Glatzmaier-Roberts model. Very simply, there is a solid iron inner core surrounded by a hot, liquid iron outer core, that rotate slightly faster than the surface of the earth. This causes electrons to flow as a convective dynamo. This electron current creates the magnetic field. I don't have a simple way to explain why the magnetic field flips over every once in a while, but the model does faithfully show that it happens. The following web site is an excellent article by Gary Glatzmaier describing this model and the outcome of the simulation. It shows that when the magnetic field flips, it may take 2000 years for it to do so, and there may be two north magnetic poles and maybe even one, two or three south magnetic poles during the transition. It also simulates the slow drifting of the magnetic poles as we have seen in real life. We just happen to be living during a time

when the poles are fairly stable, and there is only one north magnetic pole and one south magnetic pole.

<http://www.igpp.lanl.gov/Geodynamo.html>

Another good resource:

Geophysics: A magnetic reversal record

Ronald T. Merrill;

Nature Volume 389 Number 6652 Page 678 - 679 (1997)

Periodically, the Earth's magnetic field reverses, and has done so hundreds of times in the.....

The funniest answer I've heard from a student on a test about magnets is:
"Bar magnets have North and South poles, horseshoe magnets have East and West poles."





Magnet basics

Is there free energy in magnets?

Every once in a while I come across a paper or article while surfing the web which claims that it is possible to tap into the free energy which is available from the earth's magnetism, or from some other magnet.

This all sounds great, but there is the problem that energy is never free but always comes with a price.

Sure, in order to magnetize a magnet, energy needs to be put into it. This is done when a large current is pulsed through a coil in which the material to be magnetized sits. The result of this pulse of current, which contains a certain amount of energy that can be measured, is to enlarge the magnetic domains which are parallel with the magnetic field within the material being magnetized. What will cause the magnetic domains to shrink again? Three things,

1. An increase in the temperature of the magnet.
2. An external demagnetizing magnetic field.
3. Physically shaking or striking the magnet.

Each of these, as you can see, requires that energy be spent (heat, magnetic field, motion). None of these allows for a way to capture the decrease in the overall magnetic field. ([Adiabatic](#) cooling does capture some of the decrease in the overall magnetic domains, but it requires energy to be put into the material first.) Also, there are always energy losses in every circuit (in various forms of heat energy, sound energy, mechanical energy, chemical energy, electrical energy, etc).

A keyword often used by those who think they have found the secret to free energy is: over-unity. What they mean by this is that the ratio of the energy

output to the energy input is greater than 1 (more energy comes out than goes in). It sounds great, but the physics is poor. When making energy measurements, there are a number of errors that can be made, often unwittingly, that falsely indicate over-unity is possible. In reality, it isn't.

Here's a great site which explains what is often neglected by those proposing free energy devices:

<http://phact.org/e/z/freewire.htm>

In summary, there is no way to obtain free energy with any kind of combination of wires or magnets or switches (commutators, diodes, etc).





Experiments with magnets and our surroundings

Magnet math

In order to create and control magnetic fields in an exact way, we need to carefully understand how the strength of magnetic fields change depending on how far away you are from the magnet, what shape the magnet is, or if it is a solenoid or electromagnet. We also need to understand how various materials react to magnetic fields. In addition, we need to know what to call different parameters of magnets and fields and strengths and densities and so forth so we can intelligently communicate with one another.

Terms and definitions

First, let's use the right terms. This is not as straightforward as it should be, since there are three different systems of units, and each system has different names for the same parameter!

Instead of recreating an excellent article, please hyperlink to it here for a set of terms and their definitions:

<http://www.ee.surrey.ac.uk/Workshop/advice/coils/terms.html>

Conversions

Since scientists may use the MKS system of units, or the CGS system of units, or the English system of units, sometimes you need to convert units from one system to another. Every student learns some of this in high school, and every engineering and physics student becomes an expert at this in college. Here is some conversion information where the units are equivalent. For example, 1 weber = 10^8 maxwell. The units marked with **** are those most textbooks today use. You will notice that I often use lines of force and gauss and inches and amperes within this web site.

Magnetic Flux

****	1 weber
	10 ⁸ maxwell
	10*8 lines of force
Magnetic Flux Density	
****	1 tesla
	1 weber per square meter
	10 ⁴ gauss
	64516 lines per square inch
Magnetomotive Force	
****	1 ampere
	1 ampere-turn
	1.25664 gilbert
Magnetic Field Strength	
	1 kiloampere per meter
	1 ampere per millimeter
	12.5664 Oersted
	25.4000 ampere-turn per inch
****	1000 ampere per meter
	1000 newton per weber

Equations and calculations

For a thorough understanding of permanent magnetism, I have found this site to be super: <http://www.magnetweb.com>, especially their section on Permanent Magnet Design.

Now, for some equations regarding the variation of the strength of a magnetic field as the distance between you and magnet varies. Here's a very nice site which has this information: <http://www.netdenizen.com/emagnet/>

For additional information, drop to [Designing magnetic circuits](#).

Lenz's Law

Lenz's law is a basic law in electromagnetic theory for determining the direction of flow of induced currents (see [Faraday's Law of Induction](#)). It was first stated by the Estonian physicist Heinrich Lenz (1804-65).

According to Lenz's law, when a current is caused to flow in an electrical conductor by a change in the external magnetic field surrounding the conductor, the direction of flow of the current is such as to produce a magnetic field opposing the original change in the external magnetic field.

This explains the behavior of magnets and conductors when one is moving relative to the other. For example, when a conductor is moving across a magnetic field, a current is caused to circulate in the conductor producing a magnetic field which tries to stop the conductor from moving. This is the basis for the experiments described in [Pendulum](#), [Copper Pipes](#) and [Magnetic Plumb](#).

Faraday's Law of Induction

Michael Faraday lived from 1791 to 1867. In 1821, at the age of 30, he published an article titled, "On Some New Electromagnetic Motions" in the *Quarterly Journal of Science*. This changed his life and our lives in a momentous way.

He was experimenting with magnets and wires, and noticed that as a wire was moved through a magnetic field, a voltage was induced or created within the wire. If the wire was a part of a closed circuit, then current would flow.

Faraday stated that:

Whenever a magnetic force increases or decreases, it produces electricity; the faster it increases or decreases, the more electricity it produces.

The voltage induced in the wire or conductor is proportional to the rate of change of the magnetic flux (how quickly the magnetic field is changing). In other words, the faster the magnetic field is changing, the larger the voltage that is induced will be; or, the faster the wire is moving through the

magnetic field, the larger the induced voltage will be.

This is the basis for how electric motors and electric generators work!

[Lenz's Law](#) deals with the polarity of the induced voltage and the direction of the flow of current.

To learn more about Michael Faraday, check out this super book:

Five Equations that Changed the World

by Michael Guillen

ISBN 0-7868-6103-7

Hyperion

NY 1995

Maxwell's equations

For hundreds of years, people only described with words the effect a magnet would have on other objects in general ways. Then, during the 1800's, scientists started to describe these events more precisely, using numbers and formulas. It changed from a qualitative description to a quantitative description. In 1750, Franklin announced that lightning was electricity, electrical particles in motion. In 1799, Volta created the first battery. In 1819, Oersted discovered how an electric current affected a compass nearby. In 1820, Ampere ... In 1827, Ohm formulated his Ohms Laws which we all use today. In xxxx, Gauss discovered how a negative electric charge can be isolated, but a north pole can not be isolated without a south pole. In 1831, Faraday discovered how a changing magnetic field created an induced voltage, but did not describe it with a formula. Then, in 1860, Maxwell (1831-1879) put all of these together into a set of 4 equations which fully describes the relationships between current, electric fields and magnetic fields. These are the 4 fundamental equations of electromagnetism. They are the basis for how all electromagnetic devices function, and they explain a diverse range of phenomena which were previously unexplainable.

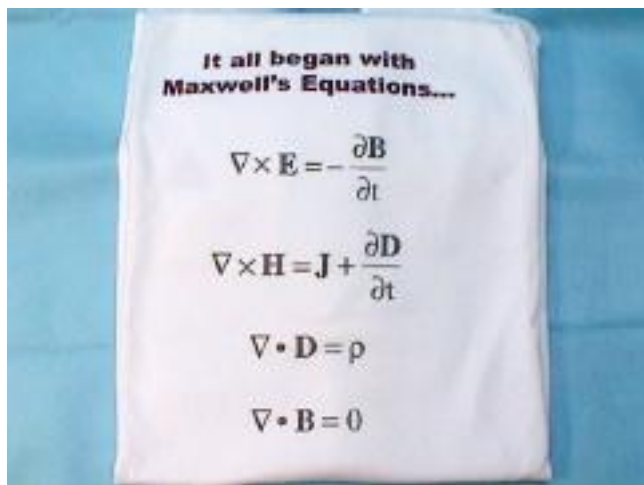

This is a tee shirt from Ansoft Corporation, giving a summary of Maxwell's Equations. What does it really mean?

The first equation is really Faraday's Law of Induction. It states that an induced electric field (\mathbf{E}) is created by a changing magnetic flux density ($d\mathbf{B}/dt$) with a polarity that opposes the changing magnetic field (-). The faster the flux density changes, the greater the induced electric field.

In the second equation, Oersted and Ampere and Gauss showed that a current (\mathbf{J}) would create a magnetic field (\mathbf{H}). However, Maxwell took it further and showed that a magnetic field (\mathbf{H}) is created by a current (\mathbf{J}) and a changing electric field ($d\mathbf{D}/dt$).

In the third equation, Coloumb and Gauss showed that an enclosed electrical charge (ρ) will create a net electric field (\mathbf{D}). In other words, if you were to enclose an electron within a soap bubble, there would be a net electric field created by that electron which is a single negatively charged particle.

The fourth equation, also by Gauss, states that an enclosed magnet will have a net magnetic flux (\mathbf{B}) of zero. In other words, every magnet has a north pole and a south pole, so that if you were to enclose even a part of a magnet within a soap bubble, the total number of magnetic field lines entering the bubble would equal the total number of magnetic field lines exiting the bubble, with a net of zero. Thus there is no monopole, or particle, which has just one magnetic pole without the other. This would be like having a magnet with just a north pole, but no south pole. Have you ever seen one? No one has. We don't think anyone ever will.

Good reference material:

http://www.phys.virginia.edu/classes/109N/more_stuff/Maxwell_Eq.html

<http://rd11.web.cern.ch/RD11/rkb/PH14pp/node108.html>

<http://www-istp.gsfc.nasa.gov/Education/whmfield.html>

Designing magnetic circuits

Designing circuits with magnetic fields is very similar to designing electrical circuits, using voltages, currents and resistors. Here are links to help you learn about magnets, and to provide you with details and examples.

www.calpoly.edu/~cm/studpage/clottich/fund.html (an excellent site!)

<http://www.magnetsales.com/>

<http://www.dextermag.com/pmp.htm>

[Introduction to Magnetism](#)

[The Science of Magnets](#)

[Magnetic Design](#)

<http://www.grouparnold.com/mtc/index.htm>

<http://www.grouparnold.com/mtc/manuals.htm>

<http://www.grouparnold.com/mtc/glossary/index.htm>

<http://www.stanfordmaterials.com/magnet.html>

<http://www.stanfordmaterials.com/magnet.html#glos>

<http://www.magnetweb.com>

See all the sections they have on design guidelines. This is a great tutorial, as all of the above sites are.

Electromagnet Design Cookbook <http://www.geocities.com/CapeCanaveral/2404/design2.html>

Transformer Design Examples (using a proprietary program) <http://www.rale.ch/constru.htm>





Experiments with magnetic levitation

How can you magnetically levitate objects?

Magnetism is fascinating, especially when it is used to cause objects to levitate or float or be suspended in the air, defying the gravity which keeps us on the ground. How can this be done? There are 10 ways to **magnetically levitate** objects:

MAGLEV Methods

1. Repulsion between like poles of permanent magnets or electromagnets. However, there needs to be a way to constrain the magnets so they don't flip over and become attracted to each other. For example, floating [donut magnets](#) have the dowel rod in the center to keep them from flipping over.
2. Repulsion between a magnet and a metallic [conductor](#) induced by relative motion. However, the magnet needs to be restrained from moving in the same direction as the conductor, otherwise it will travel with the conductor.
3. Repulsion between a metallic conductor and an AC [electromagnet](#). It is possible to shape the magnetic field to keep the conductor constrained in its motions, otherwise, a mechanical means is needed to keep the conductor in place. See also [magpie.htm](#).
4. Repulsion between a magnetic field and a [diamagnetic](#) substance. This is the case of the floating frog, and the floating magnet between two [diamagnetic](#) disks.
5. Repulsion between a magnet and a [superconductor](#). No mechanical constraints are needed for this.
6. Attraction between unlike poles of permanent magnets or electromagnets. This will work as long as there is a mechanical method to constrain the magnets so they don't touch.
7. Attraction between the open core of an electromagnetic [solenoid](#) and a piece of iron or a magnet. The iron or magnet will touch the inside surface of the solenoid.
8. Attraction between a permanent magnet or electromagnet and a piece of [iron](#). Again, the iron needs to be constrained.

9. Attraction between an [electromagnet](#) and a piece of iron or a magnet, with sensors and active control of the current to the electromagnet used to maintain some distance between them.

10. Repulsion between and electromagnet and a magnet, with sensors and active control of the current to the electromagnet used to maintain some distance between them.

A couple of interesting links:

<http://www.calpoly.edu/~cm/studpage/clottich/fund.html> (an excellent site!)

<http://www.geocities.com/Area51/Shire/3075/maglev.html>

http://www.nature.com/cgi-taf/DynaPage.taf?file=/nature/journal/v400/n6742/abs/400323a0_fs.html

Nature 400, 323 - 324 (1999) © Macmillan Publishers Ltd.
Nature magazine, July 22, 1999, p323

Magnet levitation at your fingertips

A. K. GEIM, M. D. SIMON, M. I. BOAMFA & L. O. HEFLINGER

The stable levitation of magnets is forbidden by Earnshaw's theorem, which states that no stationary object made of magnets in a fixed configuration can be held in stable equilibrium by any combination of static magnetic or gravitational forces,. Earnshaw's theorem can be viewed as a consequence of the Maxwell equations, which do not allow the magnitude of a magnetic field in a free space to possess a maximum, as required for stable equilibrium. Diamagnets (which respond to magnetic fields with mild repulsion) are known to flout the theorem, as their negative susceptibility results in the requirement of a minimum rather than a maximum in the field's magnitude,. Nevertheless, levitation of a magnet without using superconductors is widely thought to be impossible. We find that the stable levitation of a magnet can be achieved using the feeble diamagnetism of materials that are normally perceived as being non-magnetic, so that even human fingers can keep a magnet hovering in mid-air without touching it.





Experiments with magnets and conductors

Magnetic Plumb

Description:



This is another demonstration of [Lenz's law](#) and Eddy currents, similar to the [Pendulum](#) and [Aluminum Disk](#), but this time, the magnet moves with respect to the conductor. Here, a magnet hangs suspended by a string above a thick copper bar. Moving the magnet around by hand allows you to feel the strength of the induced magnetic fields. When the magnet isn't moving, there is no induced field.

Construction: EXPT



Three NIB magnets, each measuring about 1/2" diameter and 1/8" thick, are put together. A string is wound around them several times and taped, providing a way to hang the magnets from a string. (The photo on the right is an improvement I recently made to this. I attached the string to a steel button with a flat face. The magnets attach to the face of the button. This is much cleaner and neater than using several windings of string and tape. The magnets now hang straighter. I left the tape on there to keep the magnets in line.)

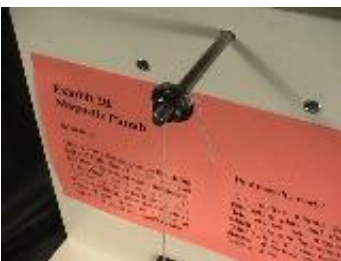

The magnets on a string are hung from a 4" 1/4x20 bolt attached to the back of the exhibit. At the

end of the bolt is a tee-nut, flat washer and hex nut. The string goes through one of the small holes in the tee-nut and is wrapped once around the bolt. The washer and hex nut then hold the string in place. The stand is made of 3/4" pressboard shelving covered with white melamine. This makes a nice, clean exhibit.

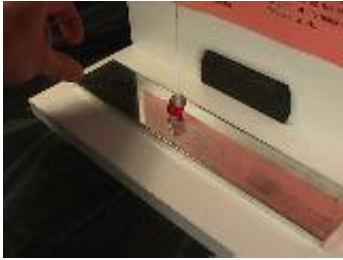

On the bottom of the exhibit is fastened a 1/4" thick bar of copper, about 3" wide and 9" long. The length of the string should be adjusted so that the bottom of the magnets is only 1/16" to 1/8" from the surface of the copper bar. The copper bar shown in the photo is tin plated so it would not tarnish, however the tarnish does not affect the way the magnet behaves. There is a foam pad on the back board so the magnet won't whack against the board and chip itself or the board's surface.

Demonstration:

Gently move the magnet on the string back and forth about 1" or 2". Can you feel the drag created when the magnet is moving? Let it swing about 1" from vertical. Now let it swing about 4" from vertical. How does it behave when it gets closer to the bar of copper?

Conclusions:

The relative motion between the conducting plate and the magnetic field induces currents in the copper plate which create magnetic fields. The orientation of the created magnetic fields is such that it opposes the motion of the swinging magnet, causing it to stop.

This would also work well with a thick piece of aluminum, perhaps 1/2" thick or more.

This is a simplified diagram showing the areas of attraction and repulsion in this experiment.

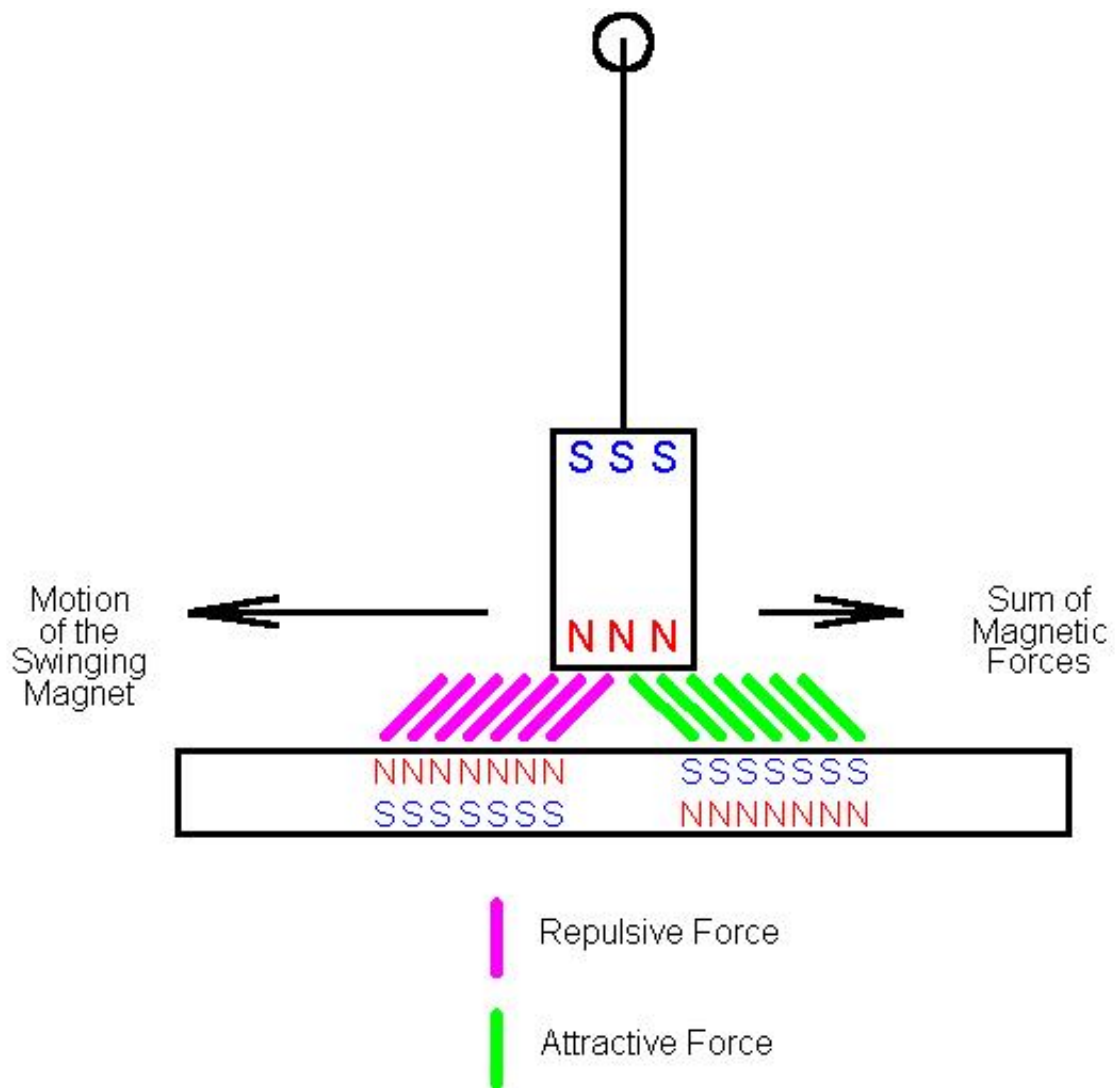



Good books on magnets

What are some good books on magnets?

I have always found books to be extremely helpful. They often provide the additional information needed for a project that can't be found elsewhere. They also give me something to do when I'm waiting for someone or in a waiting room (why read old magazines when I could read a cool book instead?). Here are some of the better books I know about on the subject of magnets and things you can do with them. Most of the books I've checked out of a library or in book stores have been very good. Listed here are books I've looked at. I own several of them, but not all. The ones I have found most fascinating are listed first. Included are links to amazon.com if you'd like to purchase one. The costs for most of the books are very reasonable (\$6 to \$12). A few are a bit expensive (\$149!). If you are going to make some demonstrations or science projects, I would recommend that you check the library on books about magnets or purchase a new or used book on magnets!

With this, you can do some searching for particular books of interest:

Search: Keywords: 

(Type in keywords like: magnets, magnetism, electromagnet, experiments with magnets, magnet experiments, etc, or the title or author of one of the books listed below.)

Books below are listed as:

Title

Author

ISBN or LCCCN

Publisher

Location and Date

Driving Force, The Natural Magic of Magnets



James D. Livingston

0-674-21644

Harvard University Press

Cambridge, Mass 1996

This book is one of the best books in print today about magnets, levitating trains, etc. If you are serious about learning what magnets are really like, I highly recommend this.

Magnetic Magic



Paul Doherty and John Cassidy

1-878257-86-2

KlutzPalo

Alto, CA 1994

Here is one of the Klutz series of books. This is a great one on magnets. They have a lot of great experiments you can do with the magnets they provide with the book. A super buy for someone who wants to play around with magnets and discover for himself / herself how magnets behave.

Magnet Science

Glen Vecchione

0-8069-0880-0

Sterling Publishing Co.

New York 1996

A very good book to start learning about magnets. More in depth than the Magnetic Magic, not as deep as Driving Force. I highly recommend it!

The Magnet Book

Shar Levine, Leslie Johnstone
Sterling Publications
1998

I've looked this over. It is a good review of magnetism along with several basic experiments.

The Magnetic Wand Discovery Guide

Brown, Riddle, Bonnell
Master Magnetics, Inc.
Castle Rock, CO 1998

I got this from Educational Innovations M-580. A great book for activities with the wand magnets.

Moo Magnet Cow Magnet Activity Kit

1-887105-00-X
Master Magnetics, Inc.
Castle Rock, CO 1995

This was also from Educational Innovations M-450, and was part of a kit with the cow magnet you can disassemble. A very well done kit. Also highly recommended.

Permanent Magnet Design and Application Handbook

Lester Moskowitz
0-8436-1800-0
Cahners Books International
Boston, MASS 1976

This book is a classic. It has everything you may want to know about permanent magnets. It includes manufacturing, design, measurement, etc. A friend of mine loaned me his copy.

A similar book by [Peter Campbell](#).

Engineer's Mini-Notebook: Magnet and Magnet Sensor Projects

Forrest Mims III
Radio Shack part number 62-5020
USA 1998

Radio Shack finally printed a great booklet, similar to others in their Engineer's Mini-Notebook series, about magnet projects. It includes a lot of different types of sensors for magnetic fields. He does a great job in providing schematics and details for those starting to build electronic projects.

Here's another good book by Mims from amazon.com.

Hall Effect Sensors: Theory and Application

Ed Ramsden
0929870581

I have not read this book, but it appears to be geared to several ways to use Hall Effect devices in various types of circuits. Should be useful in designing Gauss meters and field sensors.

Science Projects About Electricity and Magnetism

Robert Gardner
0-89490-539-9
Enslow Publishers, Inc
Springfield, NJ 1994

Science Experiments

Robert Gardner
0-531-10484-2
Franklin Watts
NY 1988

More Ideas for Science Projects

Robert Gardner
0-531-15126-4
Franklin Watts
NY 1989

Robert Gardner has a lot of good books on science and experiments of all types. [Check him out here](#).

[Experimenting with Electricity and Magnetism](#)

Ovid K. Wong
0-531-12547-5
Franklin Watts
NY 1993

[Magnets](#)

Janice Van Cleave

A very popular book, great ideas for science fairs.

200 Illustrated Science Experiments for Children

Robert J. Brown
0-8306-2825-8
Tab Books

Blue Ridge Summit, PA 1987

Electricity and Magnets

Terry Cash

0-531-19063-3

Warwick Press

NY 1989

Experiments with Magnets

Helen Challand

0-516-01279-7

Children's Press

Chicago 1986

Experimenting with Magnetism

Alan Ward

0-7910-1509-2

Chelsea House

NY 1991

Exploring Magnets

Ed Catherall

0-8114-2593-2

Steck-Vaughn

Austin, TX 1990

Physics

Paul W. Zitzewitz

0-675-17264-0

Glencoe/McGraw-Hill

Columbus, OH 1992

High school physics text book

700 Science Experiments for Everyone (newer versions of this are available)

Gerald Wendt / UNESCO

LCCCN 58-11919

Doubleday

USA 1958

Physics

David Halliday and Robert Resnick

LCCCN 66-11527

John Wiley & Sons, Inc

NY 1967

My old college physics text book

Fundamentals of Physics

David Halliday, Robert Resnick, Jearl Walker
ISBN 0-471-32000-5
John Wiley & Sons, Inc
NY 2001

Updated college physics text book, an excellent source!

Science Wizardry for Kids

Margaret Kenda and Phyllis Williams
0-8120-4766-4
Barrons
Hong Kong 1992

Advances in Permanent Magnetism

Rollin J. Parker
John Wiley & Sons, Inc
1990.

Good information on various permanent magnets and their uses.

Propulsion without Wheels

E. R. Laithwaite
Hart Publishing Company
New York, NY 1968

Describes many experiments in magnetic levitation, linear motors, etc. A very valuable book.

Gordon McComb's Gadgeteer's Goldmine! 55 Space-age Projects

Gordon McComb
0-8306-3360-X
TAB Books Division of McGraw-Hill Books
New York, NY 1990

A super book describing several cool types of projects like Jacob Ladders, Tesla Coils, lasers, superconductivity, etc.

Power Electronics and Variable Frequency Drives

Bimal Bose
0-7803-1084-5
IEEE Press
Piscataway, NJ 1997

A thorough review of various types of AC motors and variable speed drives, especially for the professional or the advanced college student.

Electric Motors and Control Techniques

Irving Gottlieb

Another good book on motors and drives.

Additional books I have not seen, but have found referenced by others:

Bleaney, B. I., Electricity and Magnetism, 3d ed. (1989)

Duffin, W. J., Electricity and Magnetism, 4th ed. (1990)

Chen, Chi-Wen, Magnetism and Metallurgy of Soft Magnetic Materials (1986)

Davis, A. R., and Rawls, W. C., Jr., Magnetism and Its Effects on the Living System, 4th ed. (1988)

Hargraves, R. B., ed., The Physics of Magnetic Processes (1980)

Ishikawa, U., and Miura, N., eds., Physics and Engineering Applications of Magnets (1991)

Jakubovics, J. P., Magnetism and Magnetic Materials (1987)

Jiles, David, Introduction to Magnetism and Magnetic Materials (1991)

Kaganov, M. T., and Tsukernik, V. M., The Nature of Magnetism (1985)

Lee, E. W., Magnetism: An Introductory Survey (1970; repr. 1984)

Mattis, D. C., The Theory of Magnetism II (1985)

Besides checking the bookstores or libraries, you may want to try to obtain some of the above books through an inter-library loan program your public library may have. This way, some of the more advanced texts would be available to you from a nearby engineering school. I've checked out some great books this way, especially those that are on physics demonstrations. They have a lot of great material on magnets. For example, you may want to request the following:

A Demonstration Handbook for Physics

G.D. Freier and F.J. Anderson

American Association of Physics Teachers

Stony Brook, NY 1981

Physics Demonstration Experiments Vol 2 (Heat, E&M, Optics, Atomic and Nuclear Physics)

Harry F. Meiners

The Ronald Press Company, NY

1970

Demonstration Experiments in Physics

Richard M. Sutton

American Association of Physics Teachers

McGraw-Hill Book Company, NY

1938

[Physics Demonstrations, A Sourcebook for Teacher of Physics](#)

Julien C. Sprott

1996

Another link to a whole list of [books on several subjects for projects](#).



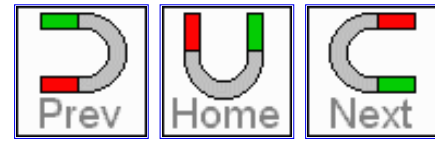

Experiments with magnets interacting with other magnets

Donut magnets

Description:



This is actually a demonstration of levitation. We have North (N) poles facing N poles and South (S) poles facing S poles.

Construction:



This is made with seven donut magnets placed N to S to N to S. Then, three are placed N to N and S to S. A wooden dowel, about 1/4" in diameter, is glued into two 2" by 2" blocks after the magnets were placed on it. A trick to make this look good is to make the dowel rod just a little smaller than the inside diameter of the donut magnets. If the dowel is too small, the magnets will sit at an angle.



Dowling Magnets has a nice collection called "Floating Magnet Rings" pictured here. A clever touch is that they place an "O" ring between each magnet ring so they don't bang against each other and break. One of the donuts on my set broke when someone shook the assembly up and down. The "O" rings would help with that.

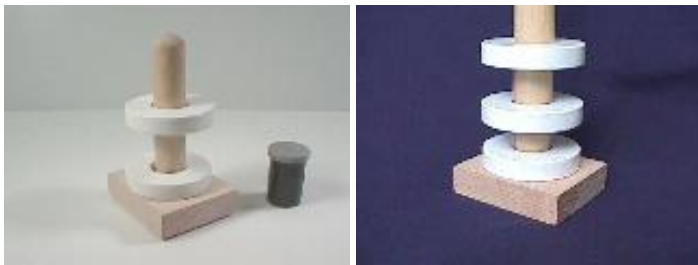

If you purchase some larger donuts, such as these which measure 2-7/8" OD (outer diameter) by 1-1/8" ID (inner diameter) and 9/16" thick, you can place them onto a larger dowel rod and have fun playing with them.

Arbor, Edmund 37-621, AS&S 28807, EdIn

Demonstration:



This is a great exhibit to play with, causing the three floating donuts to bounce, or turning them upside down as shown above and still seeing a gap between the three floaters on the bottom.

Conclusions:

Again, this demonstrates the repulsion between like poles and attraction between unlike poles. It provides a way to feel the strength of the repulsion as the distance varies. It also shows a way to levitate objects as long as they are constrained from flipping over.

This is a simplified diagram showing the areas of attraction and repulsion between the magnets for this experiment.

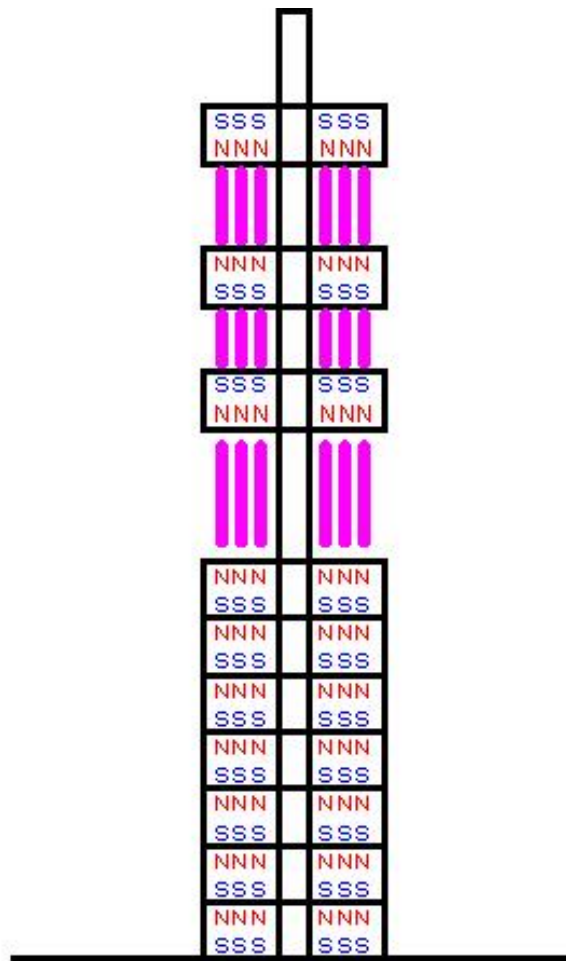

 Repulsive Force





Links to other sites of interest

Information on Christianity

- [Center for Reformed Theology and Apologetics](#)
- [The Dead Sea Scrolls](#)
- [The Four Spiritual Laws](#)
- [The Christian Connection](#)
- [Biblical Studies](#)
- [Christian Answers](#)
- [Reasons to Believe](#)
- [Christian Internet Resources](#)
- [The Bible Gateway](#)
- [OT Bible Commentaries](#)
- [Gospel Communications Network](#)
- [Christian Classics Ethereal Library](#)
- [Reformed Church of America](#)
- [World Wide Study Bible](#)
- [Institute for Christian Leadership](#)
- [Christian Research Institute](#)
- [Promise Keepers](#)
- [Bible Study and Reference Tools](#)
- [DramaShare](#)
- [Timo's Christian Clip Art Site](#)
- [Religious Images, Icons, and Art](#)
- [The Internet Christian Resource Center](#)
- [NetMinistries Biblical Material and Church Documents](#)
- [The Christian Theology Page](#)
- [Christian Youth Resources on the Net](#)

Christian Music

- [NetCentral](#)
- [Christian Music Online](#)
- [Contemporary Christian Music](#)
- [Choral Music Links](#)

RCA Colleges and Seminaries with Home Pages

- [Hope College, Holland, MI](#)
- [Central College, Pella, IA](#)
- [Northwestern College, Orange City, IA](#)
- [Western Theological Seminary, Holland, MI](#)
- [New Brunswick Theological Seminary, New Brunswick, NJ](#)

Other Christian Colleges and Seminaries

- [Calvin College, Grand Rapids, MI](#)
- [Wheaton College, Wheaton, IL](#)
- [Westminster Theological Seminary, Philadelphia, PA](#)
- [Biola University, La Mirada, CA](#)
- [Dallas Theological Seminary, Dallas TX](#)
- [Texas A&M University, College Station, TX](#)
- [Moody Bible Institute, Chicago, IL](#)
- [Coalition for Christian Colleges and Universities](#)
- [others](#)

Christian Campus Organizations

- [InterVarsity Christian Fellowship](#)
- [Campus Crusade for Christ](#)

Family Fun Sites

- [Crayola](#), how they make crayons, markers
- [Kids.Com](#), kids fun, games toys, friends
- [KidsSat](#) for information about satellites and space telescopes
- [World Time-Zone Map](#)

- [Online Bookstore - Amazon](#)
- [Library Stacks at AT&T](#)
- [College Network Switchboard: Find a friend](#)
- [The Weather in Milwaukee](#)
- [IntellicastWeather Information](#)
- [Welcome to the Planets](#)
- [Education Center Directory](#)
- [Search for Something, using AltaVista](#)
- [Where do you live? Map of USA](#)
- [More Maps](#)
- [Auto Buyers Guide](#)
- [What Time is it?](#)
- [News and Information](#)
- [Links for Families](#)
- [Ameritech Family Resources](#)
- [FamilySurf](#)
- [NetMinistries Kids' Links](#)
- [Astronomy with the Star Hustler](#)





How you can become a Christian

Receiving Jesus Christ as your personal Lord and Savior is the most important decision you will ever make.

If you want to experience the joy of being a Christian, please allow us to share with you these four steps to peace with God:

1 Realize that God loves you and has a wonderful plan for your life.

2 Acknowledge that you are sinful and separated from God.

3 Recognize that Jesus Christ is God's only provision for man's sin.

4 Trust Jesus Christ and receive Him by faith.

We would be excited to assist you in this important decision, welcome you into the family of God, and offer you opportunities to grow in your faith.

[Click here for more information.](#)

[Please let us know if you made a decision.](#)

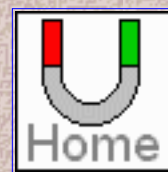



Cool Puzzles and Toys

This web site is devoted to cool puzzles and toys that don't use magnets. (If you like magnets, check out [Magnet Man](#)). I have enjoyed discovering the world of pentominoes, and have some great links to pentomino solvers and artwork. I also have information on some interesting toys for the executive's desk.

Have fun!

Rick Hoadley

Last updated: 11/26/03. More to come!

Pentominoes

- [What are pentominoes?](#)
 - [Links to other sites](#)
 - [Books on pentominoes](#)
-

Executive toys

- [Fun items for the top of your desk](#)
-

Do you have other puzzles or toys that should be mentioned here or linked here?
Let me know what you think. [Drop me a note!](#)

Thank-you for being visitor number since May,2000.





Experiments with magnets interacting with other magnets

Herky Jerky

Description:



This exhibit shows the unpredictable nature of three magnetic fields interacting with one donut magnet on a string.

Construction:

This is very simple to make. All that is needed are four donut magnets and a way to suspend one from a string so it can move about. The black foam disk on the back wall of the stand is to prevent the magnet from hitting it too hard and breaking.

The stand is made of 3/4" presswood shelving with a white melamine finish. It measures about 11.75" wide by 12" tall by 6.75" deep.

Demonstration:

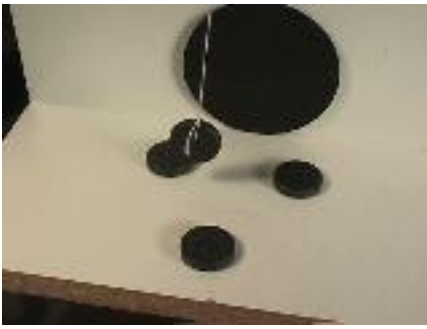

Pull the magnet on the string to the side about 4" and let it go. You will see it bounce around from magnet to magnet as it interacts with their fields. It will spin and wiggle and jiggle and keep on doing it for a long time.

Conclusions:

I found this described in the book [Magnetic Magic](#). There are a lot of other cool experiments in that book, too.





Magnet basics

Safety Considerations

When using some of the magnets described in these experiments, for example NIB (Neodymium - Iron - Boron) magnets which are a lot stronger than those that barely hang onto the refrigerator door with a single piece of paper under it, you need to observe certain safety precautions:

Be careful when handling strong magnets.

Don't let them snap to each other because they will chip or break and small pieces will go flying off.

Wear safety goggles so those small chips don't lodge into your eye!

Slowly allow the magnets to come together, watching that your fingers don't get pinched. These magnets have caused blood blisters on the fingers of those who were not prepared. *(I am now prepared!)*

Don't drop the magnets. Not only will they chip or break, but the impact will also affect the strength of the magnet.

Watch out where you place these strong magnets.

If they are placed close to a video tape, portions of the tape will be erased or messed up.

If they are placed close to an audio tape, portions of the tape will be erased or messed up.

If they are placed close to credit cards, the magnetic strip on the back of the card will be erased or messed up.

If they are placed close to a floppy disk, large portions of the disk will be erased or messed up.

If they are placed close to a TV screen or computer monitor, the screen's colors will become distorted, and it is not easy to fix it!

If they are placed close to a mechanical watch, the watch can become damaged. (I found that some stainless steel hardware was slightly attracted to NIB magnets, while other stainless steel hardware was not.)

If they come close to hearing aids or pacemakers, I don't know what might happen, and I don't want to find out!

In general, please handle with great care!





Magnet basics

Ten Facts about Magnets

(from the book [Driving Force](#))

1. North poles point north, south poles point south.
 2. Like poles repel, unlike poles attract.
 3. Magnetic forces attract only magnetic materials.
 4. Magnetic forces act at a distance.
 5. While magnetized, temporary magnets act like permanent magnets.
 6. A coil of wire with an electric current flowing through it becomes a magnet.
 7. Putting iron inside a current-carrying coil increases the strength of the electromagnet.
 8. A changing magnetic field induces an electric current in a conductor.
 9. A charged particle experiences no magnetic force when moving parallel to a magnetic field, but when it is moving perpendicular to the field it experiences a force perpendicular to both the field and the direction of motion.
 10. A current-carrying wire in a perpendicular magnetic field experiences a force in a direction perpendicular to both the wire and the field.
-





Experiments with magnets and our surroundings

Magnetic fields

Single bar magnet

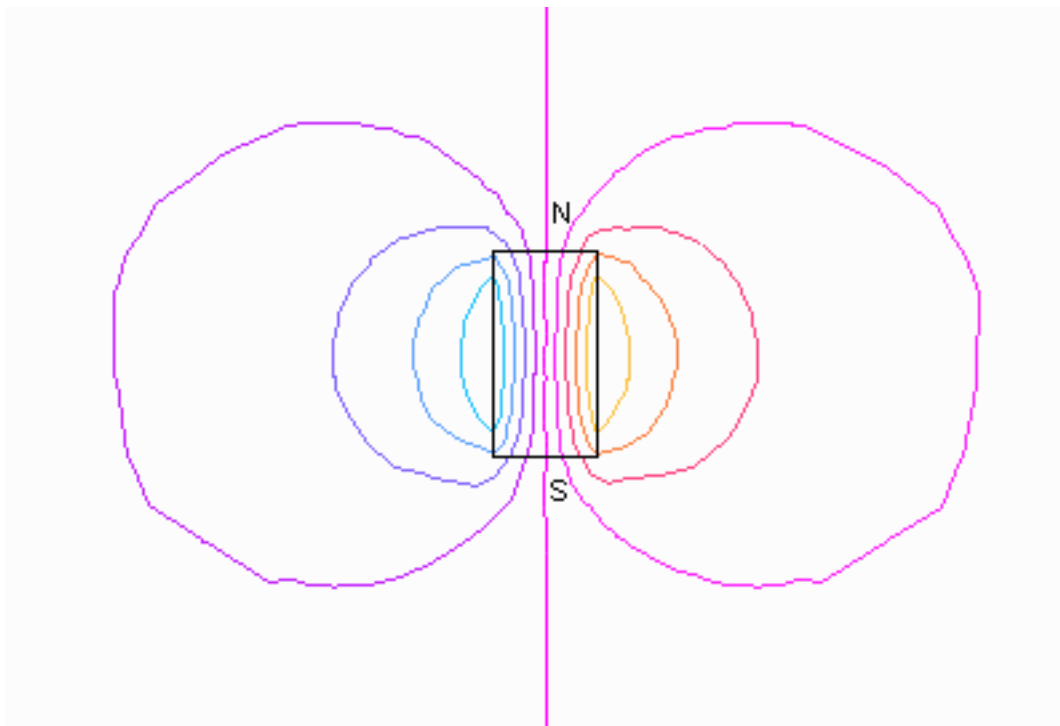

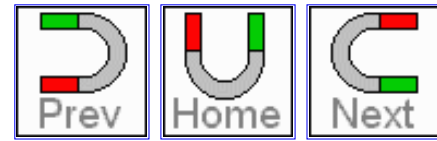

Experiments with magnets and our surroundings

Magnetic fields

Two bar magnets end to end, N to S, with a gap between them

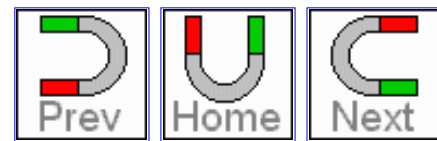
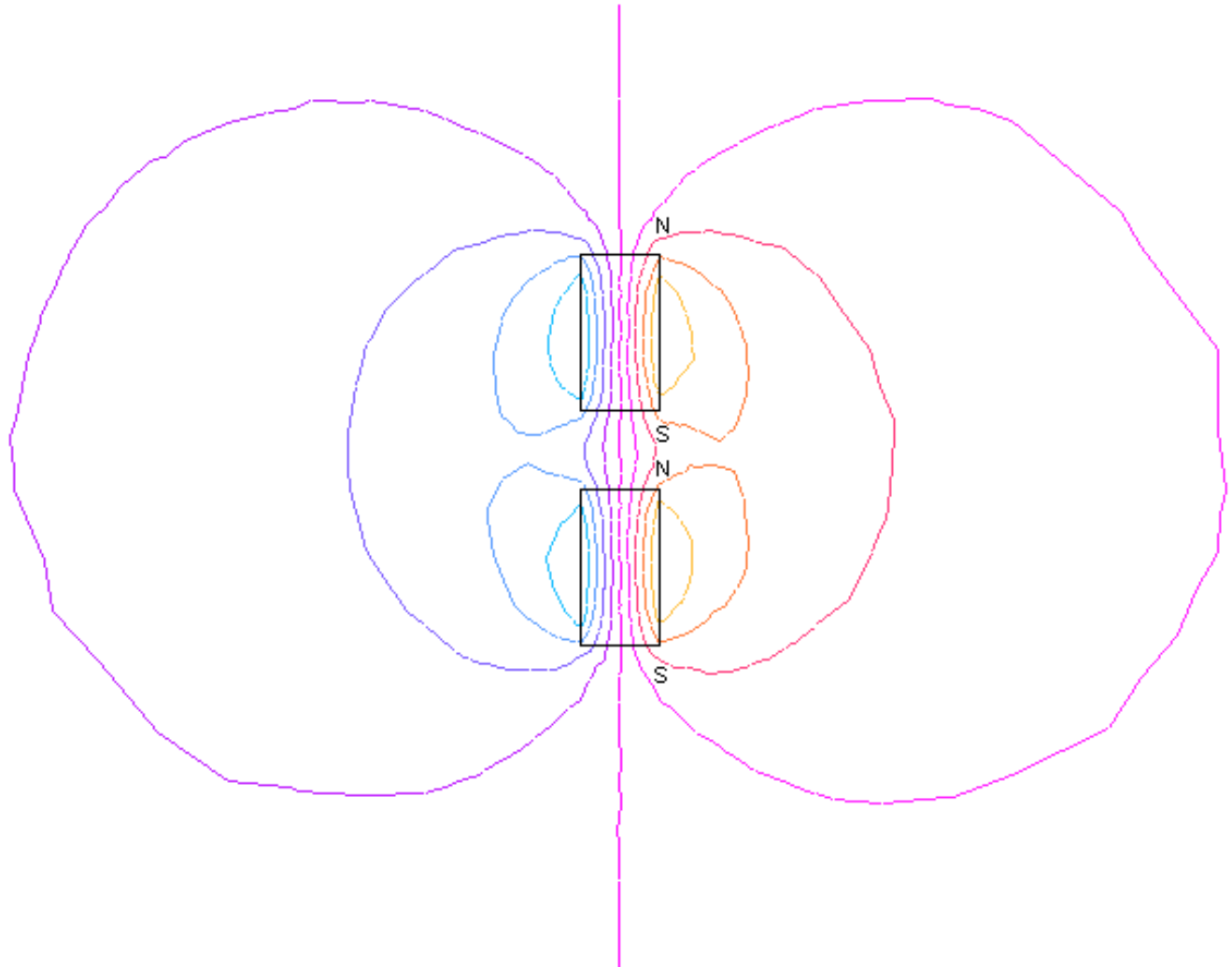



Experiments with magnets and our surroundings

What do magnetic fields look like?

Two bar magnets end to end, N to N, with a gap between them

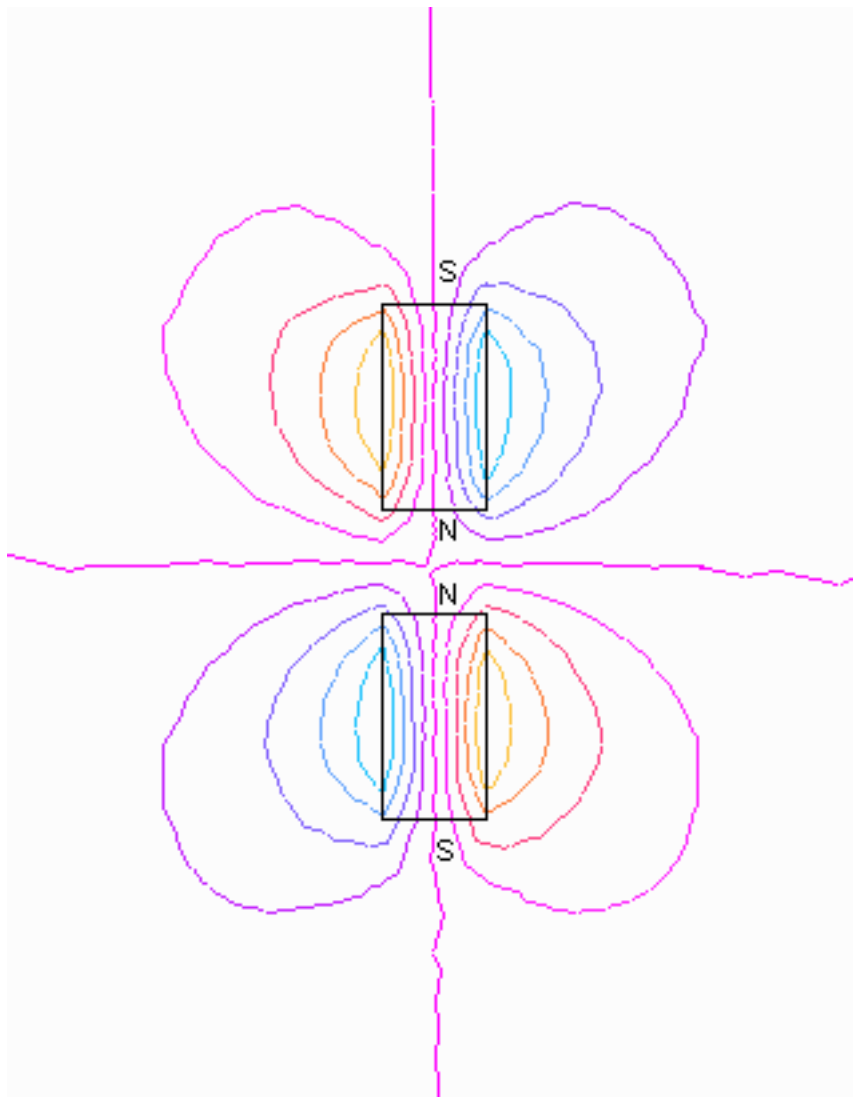



Experiments with magnets and our surroundings

Magnetic fields

Two bar magnets end to end, S to S, with no gap between them

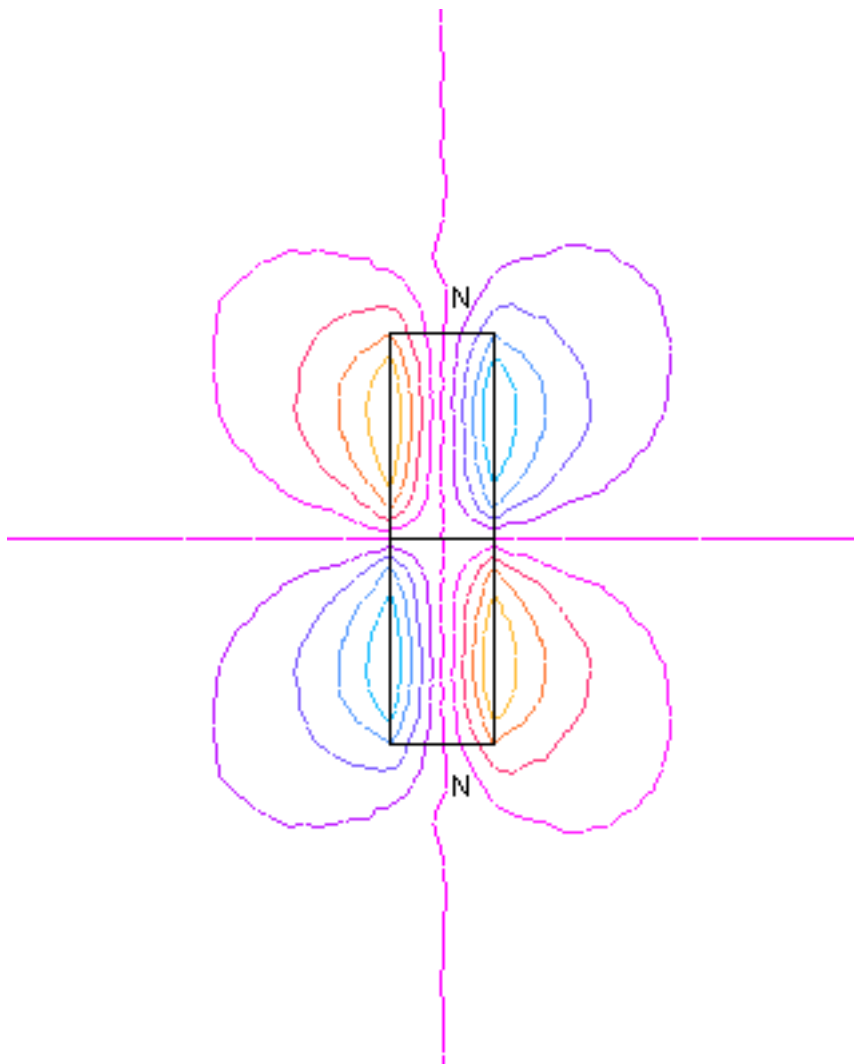



Experiments with magnets and our surroundings

What do magnetic fields look like?

Two bar magnets side by side, N by N, with a gap between them

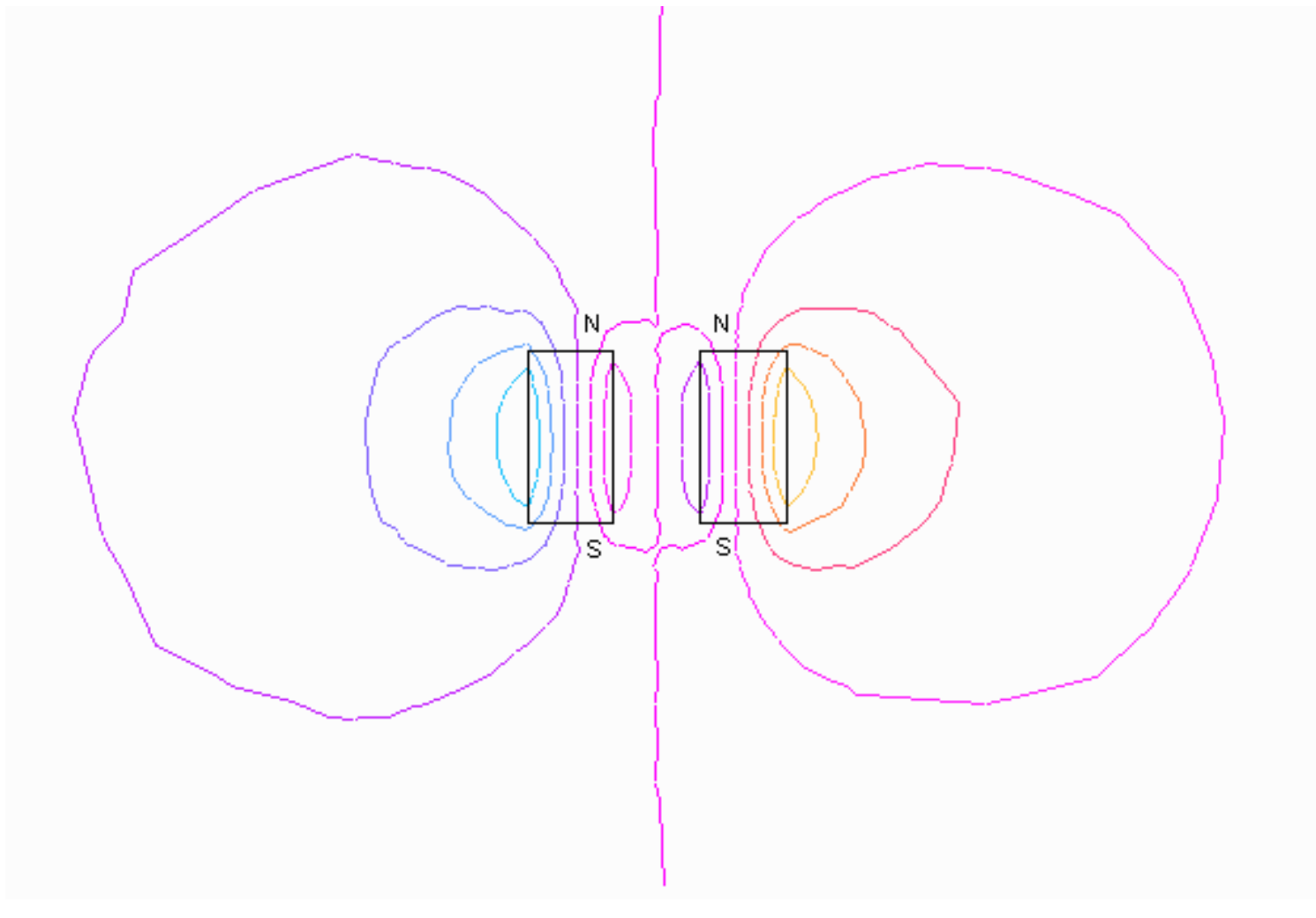



Experiments with magnets and our surroundings

What do magnetic fields look like?

Two bar magnets side by side, N by S, with a gap between them

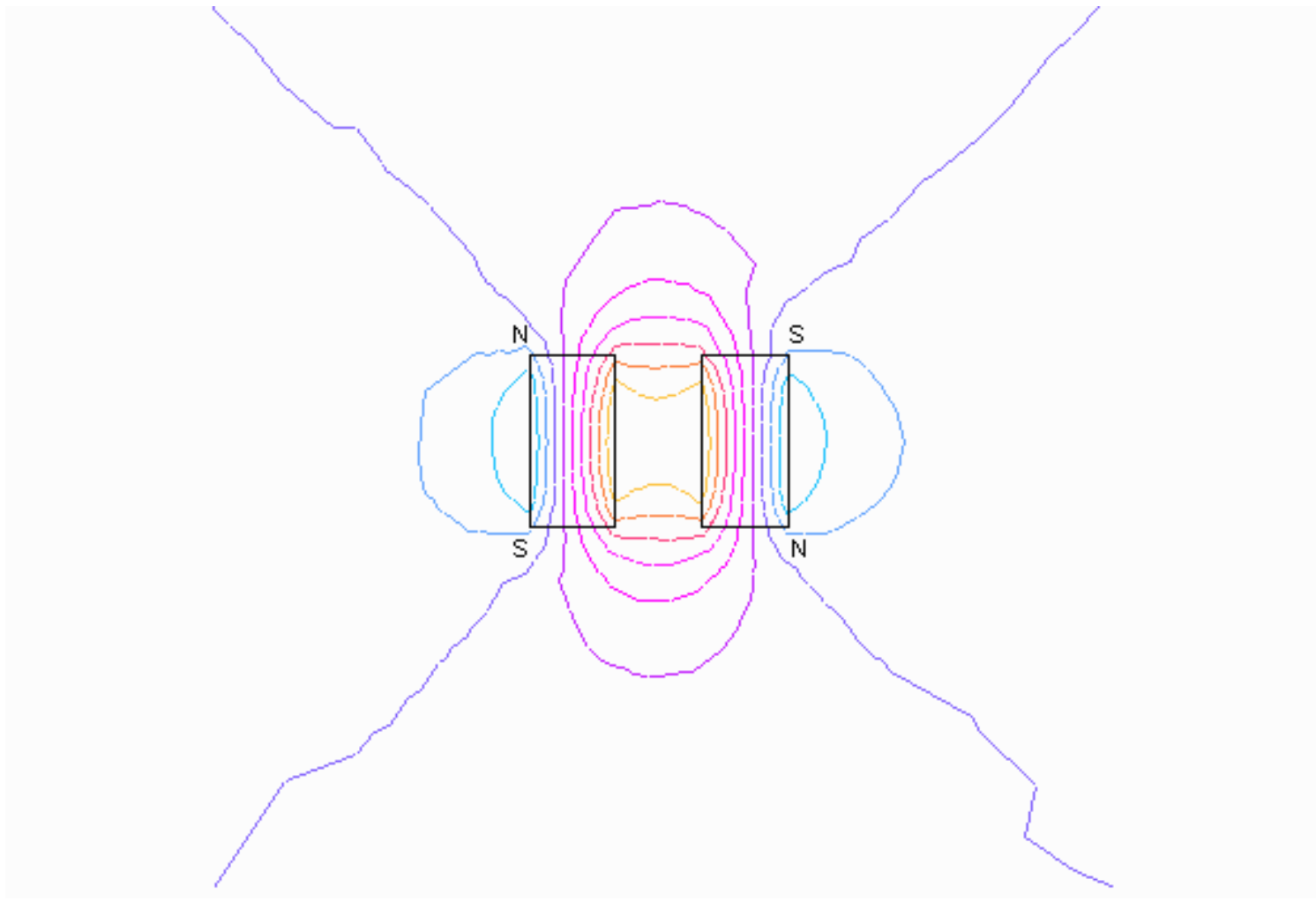

Experiments with magnets and our surroundings

What do magnetic fields look like?

DC electromagnet with an air core

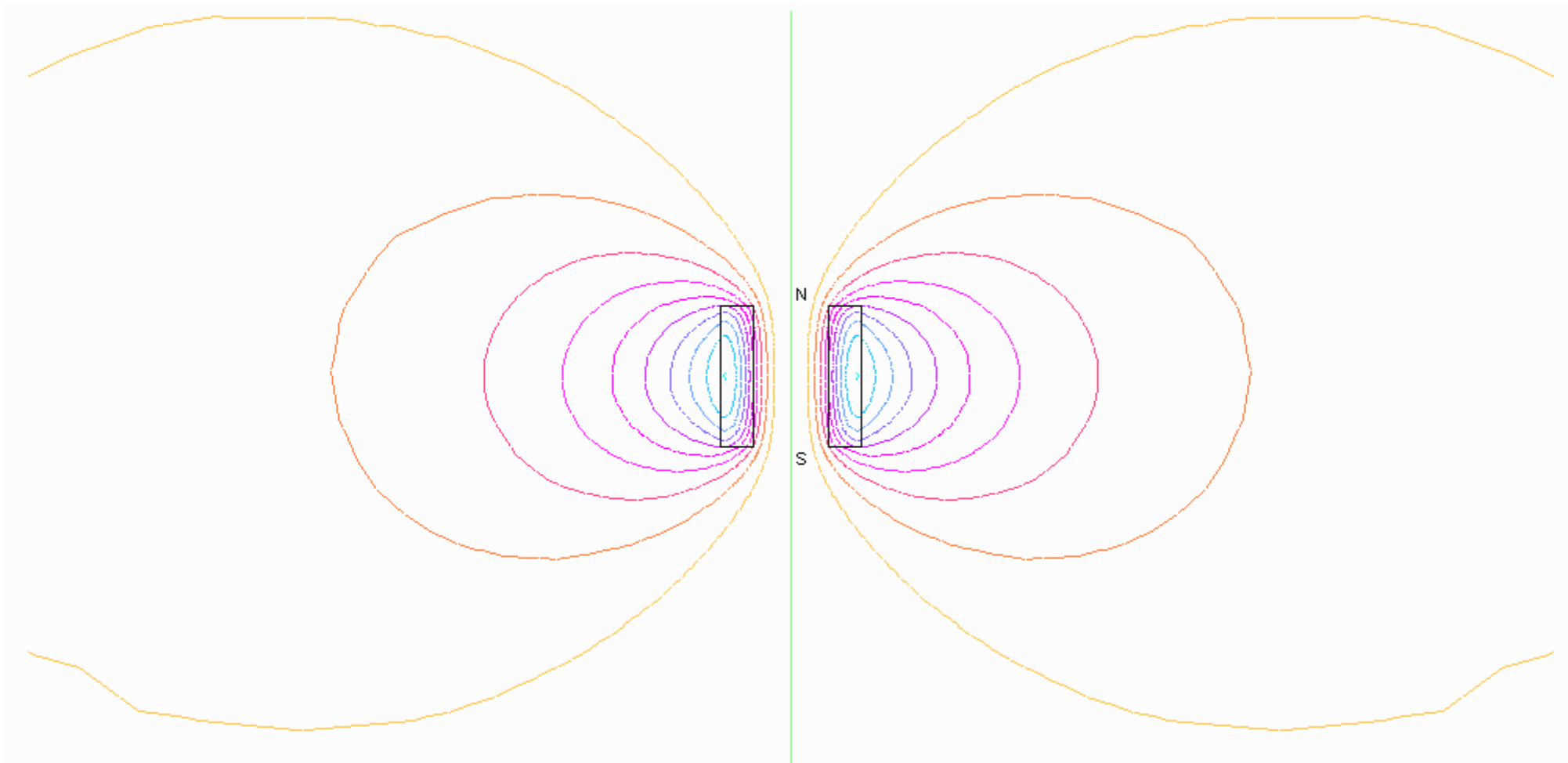

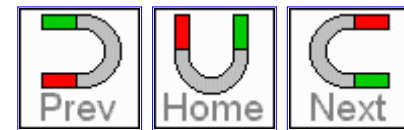



Experiments with magnets and our surroundings

What do magnetic fields look like?

DC electromagnet with a soft iron core

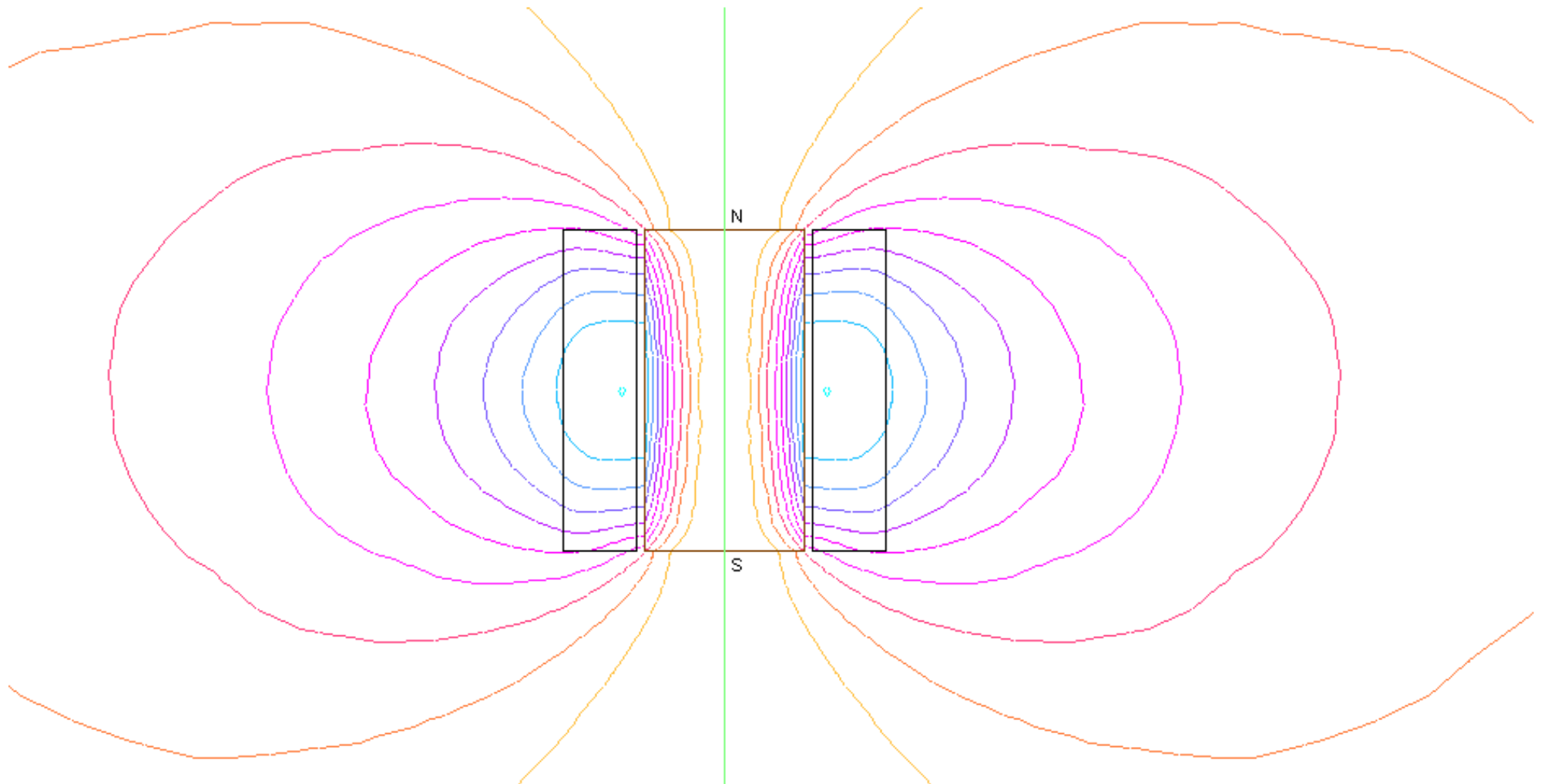



Experiments with magnets and our surroundings

What do magnetic fields look like?

DC electromagnet with a soft iron core, with a small permanent magnet below it

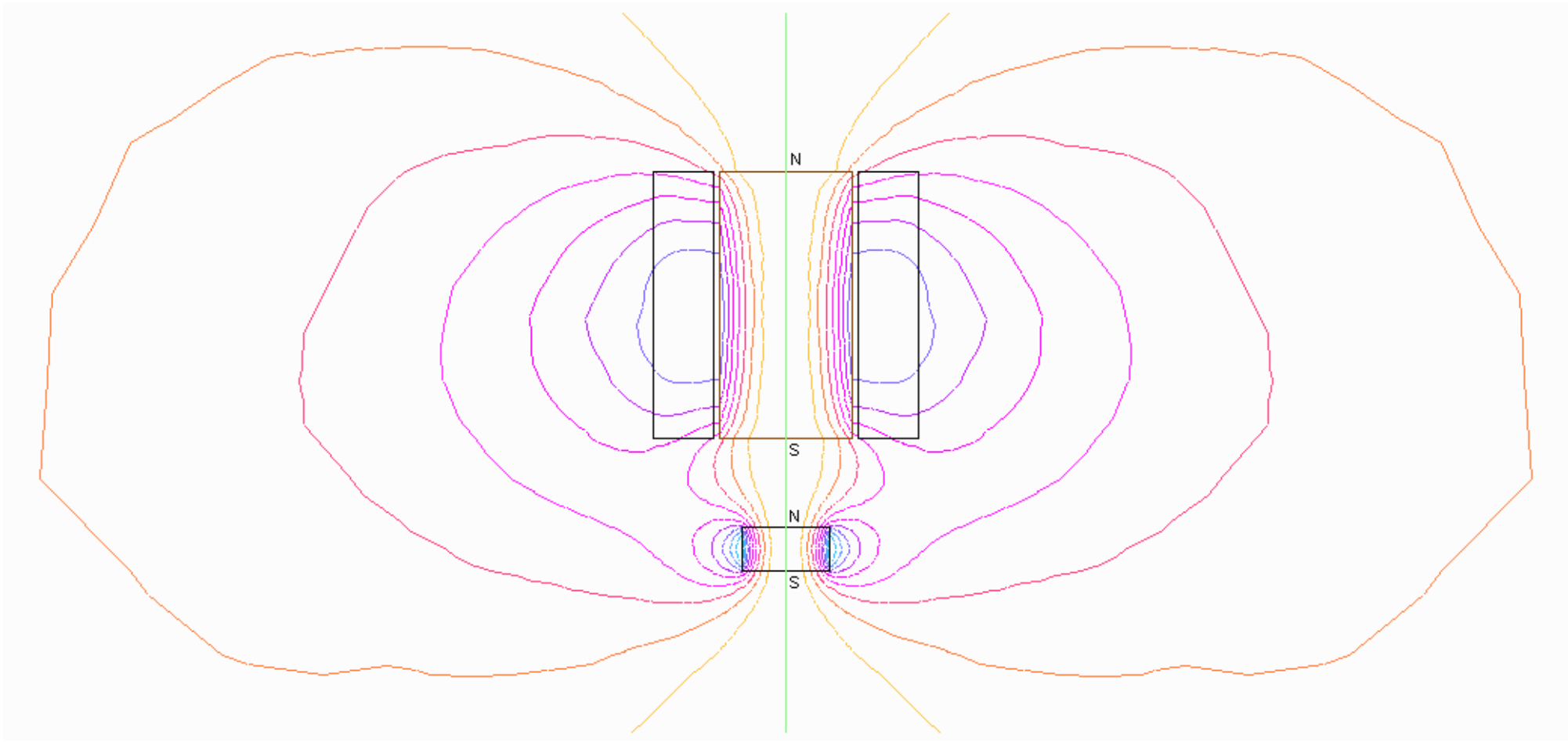

Field of DC electromagnet with a soft iron core, with a small permanent magnet below it

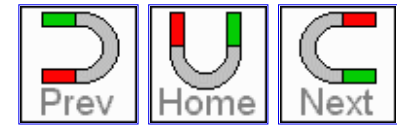

Experiments with magnets and our surroundings

What do magnetic fields look like?

Single donut magnet

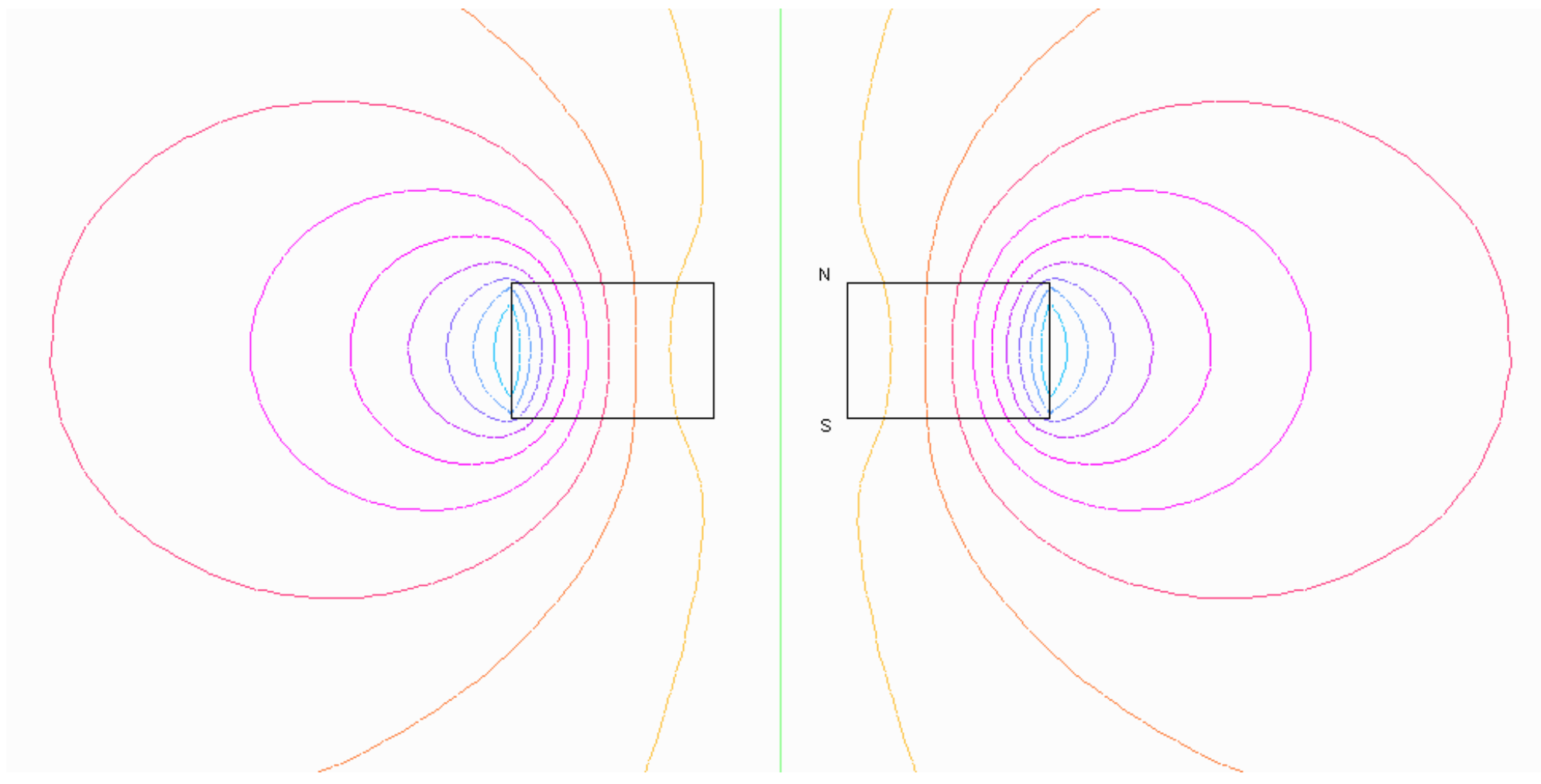

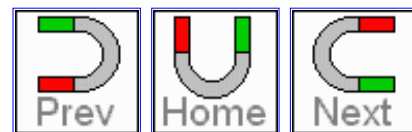



Experiments with magnets and our surroundings

What do magnetic fields look like?

Group of six donut magnets, three stuck together, three levitated above

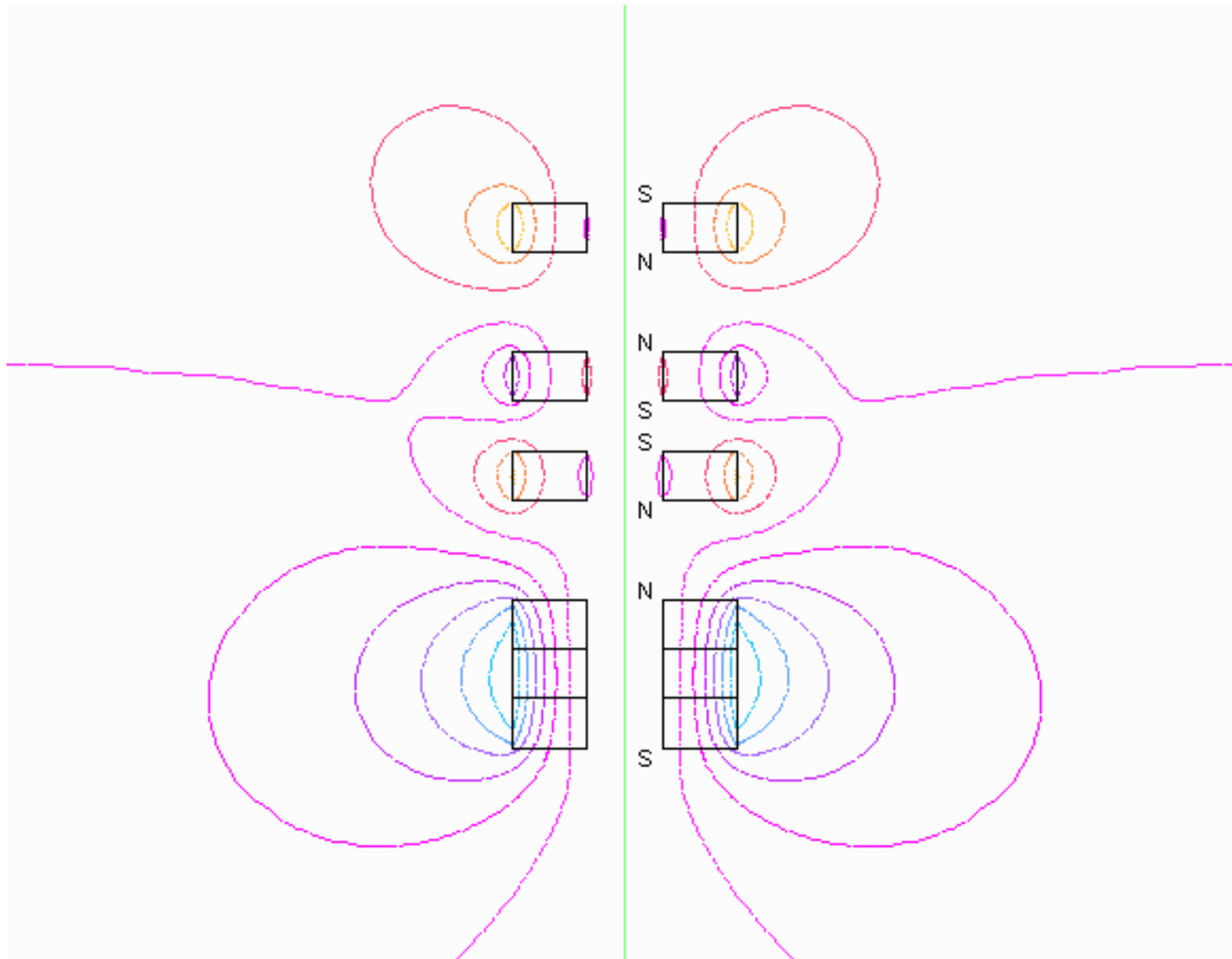



Experiments with magnets and our surroundings

What do magnetic fields look like?

Levitating train platform above its magnetic tracks

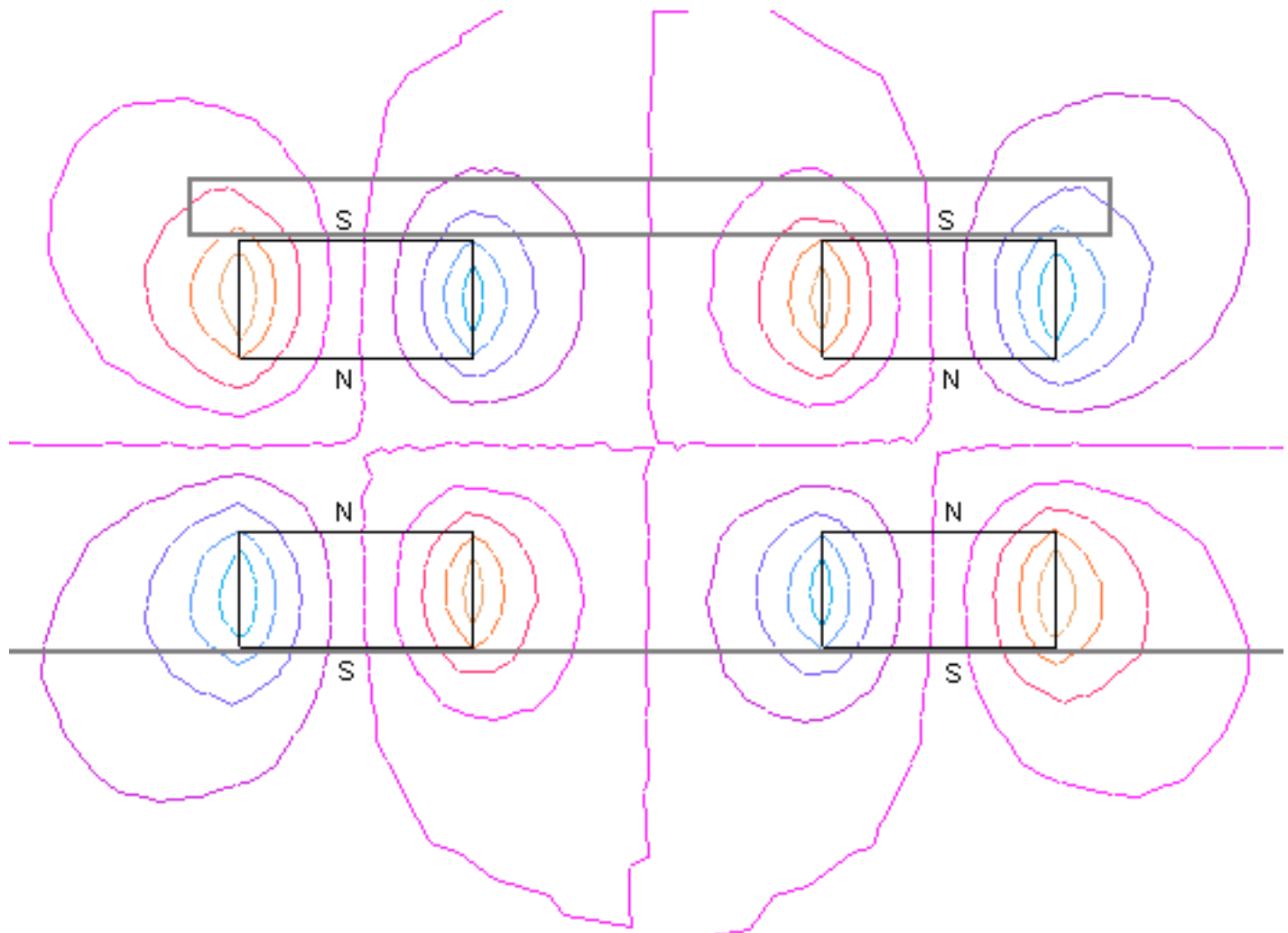



Experiments with magnets and our surroundings

What do magnetic fields look like?

Two disk magnets, stuck together, about to be slid apart (sometimes this is the only way to pull two magnets apart!)

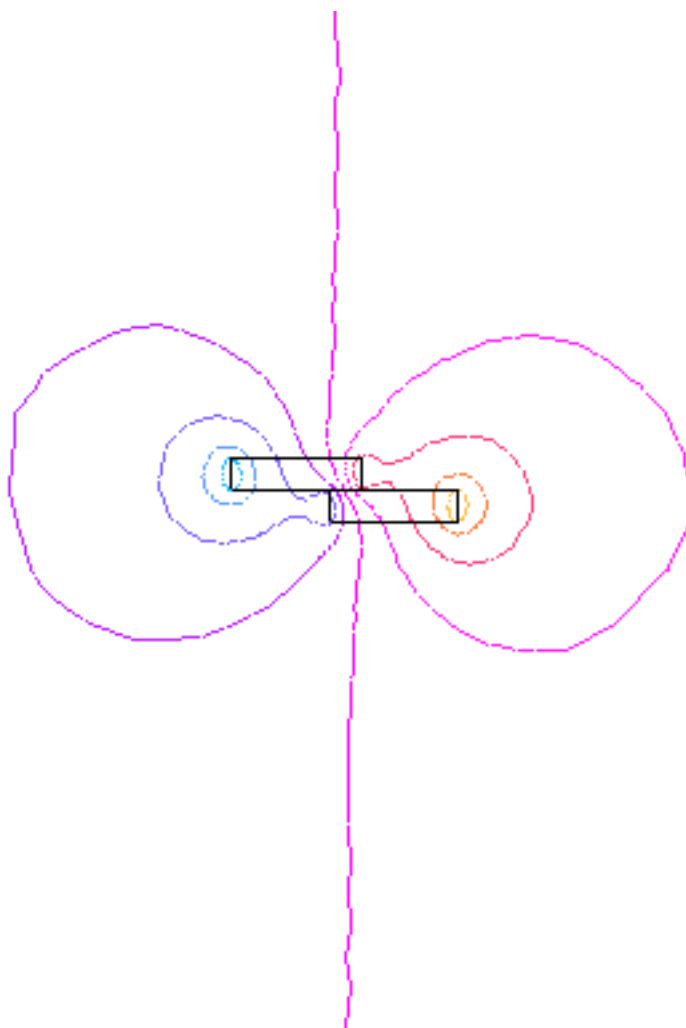



Experiments with magnets and our surroundings

What do magnetic fields look like?

Two hemispherical magnets, with a gap between them

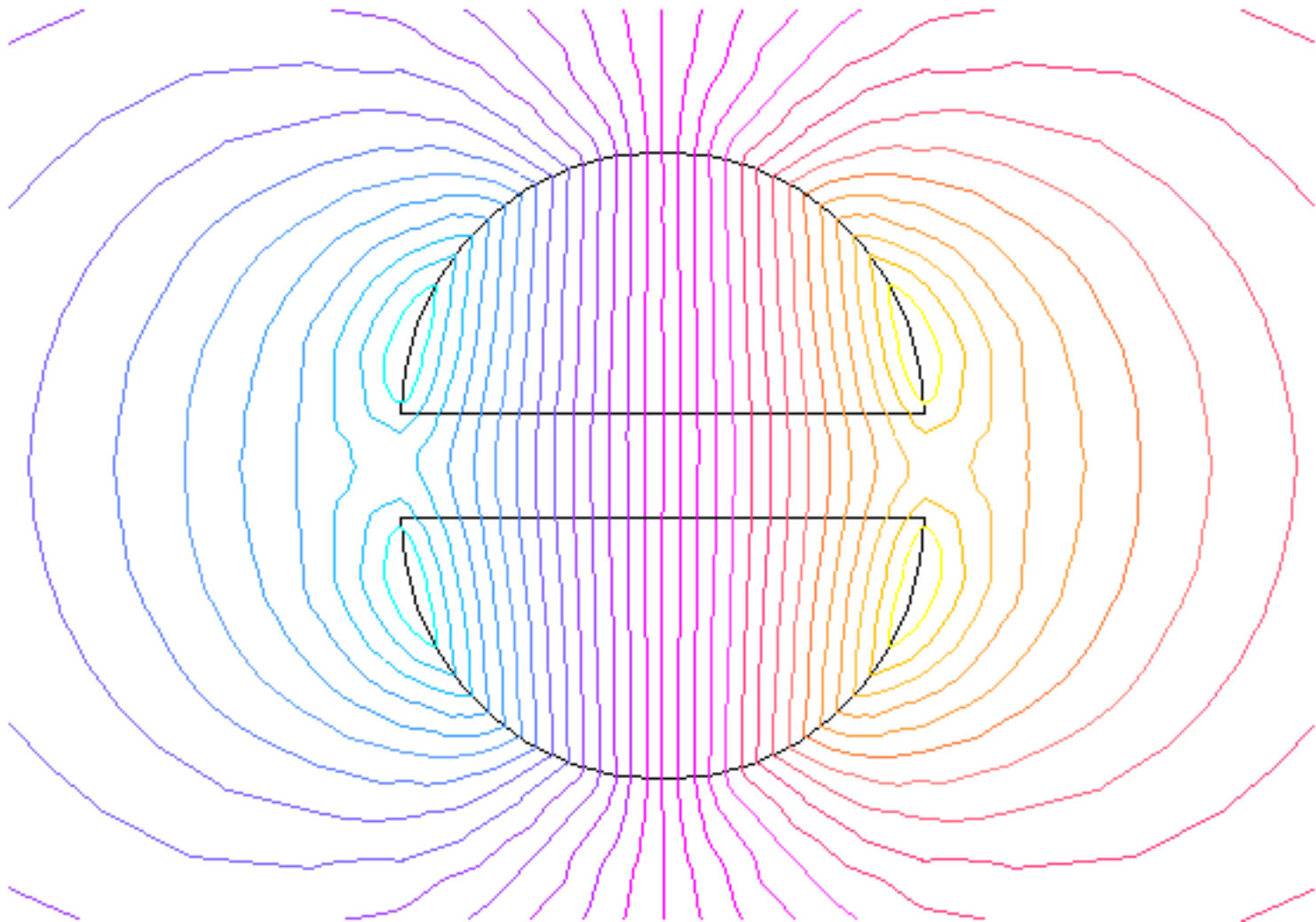



Experiments with magnets and our surroundings

What do magnetic fields look like?

A spherical magnet.

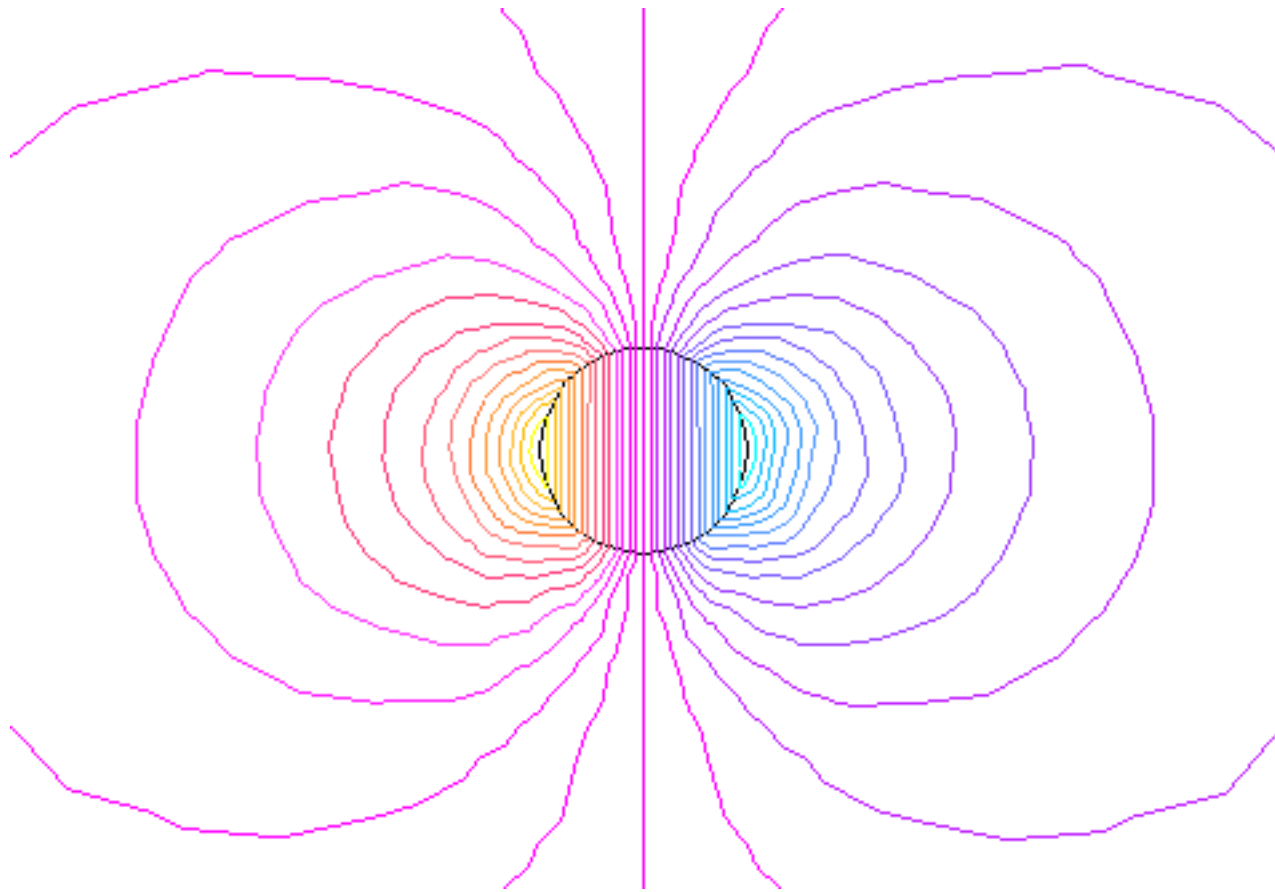

A magnetic core like that of the earth.

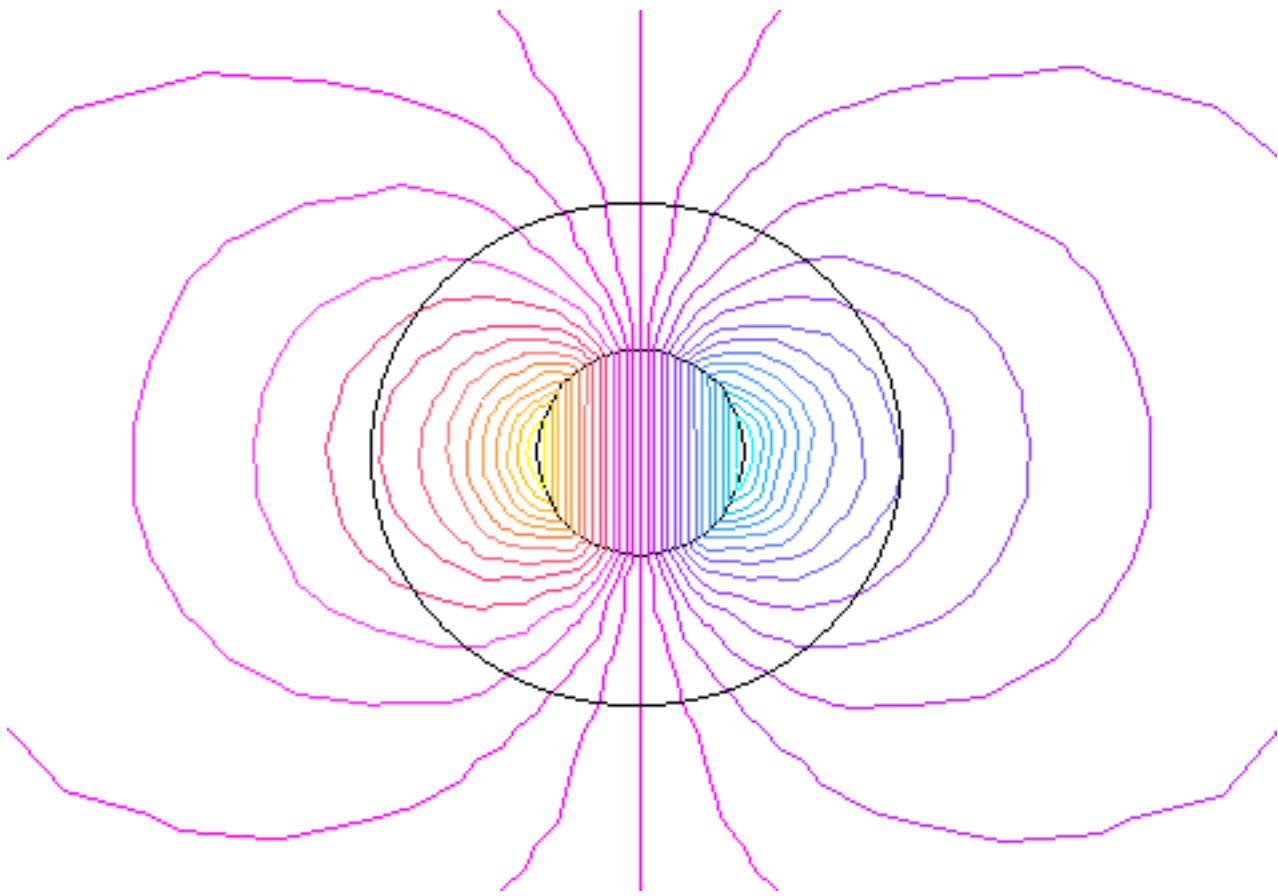



Experiments with magnetic levitation

Floating Plate EXPT

This is an experiment which involves an aluminum plate or flat sheet which floats in the air above a set of laminations and coils. These demonstrations do require some skill in assembly and winding coils.

Again, eddy currents are the means by which the magnetic field within the plate will repel the magnetic field produced by the coil. Details are given in:

Propulsion without Wheels

E. R. Laithwaite

Hart Publishing Company

New York, NY 1968

see pages 190-196





Experiments with motors

Generators

Electric generators are used to efficiently convert mechanical energy into electrical energy. Magnetism is the basis of their principles of operation. They use permanent magnets, electromagnets, and exploit the magnetic properties of materials in order to create these amazing machines.

The generators used to produce the voltages used in your home and in industry are large units, usually connected to a turbine which is powered by steam. The stand-by or emergency generators available for your home or camper are typically 4 to 10kW, and are powered by gasoline engines.

There are two basic types of generators:

DC generators

- Used in older cars

- Used in older machine shops as a source for DC power for their DC motors

AC generators

- Three-phase

 - Present day power generators

 - Used in today's cars, called alternators (they have diodes built in, to convert the AC into DC for charging the battery)

- Two-phase

 - Used in the emergency home generators, provides two 120V circuits which are combined to give a 240V circuit.

What happens when a wire moves with respect to a magnetic field?



This is the **Right Hand Rule** for generators.

The first finger points in the direction of the magnetic field (first - field), which goes from the North pole to the South pole.

The thumb points in the direction of the motion of the wire in the magnetic field (thumb - torque or thrust).

The second finger then points in the direction of the induced current in the wire (second - current).

So, when a wire moves perpendicular to a magnetic field, cutting through the magnetic field lines, a voltage is induced across the wire. If the wire is part of a closed system, then current will flow. The faster the wire moves, the larger the amount of induced voltage and current. Please note that it does not matter whether the wire is moving or the magnetic field is moving, but that they move with respect to each other. If the wire moves parallel with the magnetic field, there will be no induced voltage or current.

This is what [Faraday](#) discovered.

Tethers in Space

If a long wire can be stretched between the space shuttle and a weight of some kind, so that it lies perpendicular to the surface of the earth, then the wire will be cutting through the earth's magnetic field lines, then a voltage will be induced in the wire. This is called an electrodynamic tether in space.

Now, if the ends of the wire can create a plasma to allow a current to flow along the wire, into the plasma, along the magnetic field lines of the earth to a lower level in the atmosphere, then back again to the other end of the wire (creating a closed system), then current will flow. How much? They expect about 2kV across a 10km tether, allowing about 10A to flow, thus achieving

a 20kW generating system at 90% efficiency.

This is great! There is a proposed system which would use this tether for providing thrust or braking force, or providing power to the spacecraft. However, if it provides power to the spacecraft, it causes it to slow down (as you would expect since it is taking one form of energy and converting into another).

For further reading, please check these out:

<http://liftoff.msfc.nasa.gov/academy/tether/tethers.html>

<http://www.airseds.com/tethersinfo.html>

<http://www.physics.ucla.edu/plasma-exp/Research/TetherModeling/index.html>

http://science.nasa.gov/newhome/headlines/ast22jan99_1.htm





Experiments with electromagnets

Floating Tube

Description:



This shows another example of [Lenz's law](#), where the magnetic field is changing due to the AC voltage applied to the coil, and the section of copper tubing is caused to levitate on the bolt.

Construction:

The construction is the same as the [AC electromagnet](#). The only additional piece of hardware needed is a section of copper tubing or pipe.

Demonstration:



With the short section of copper tube in place on the end of the bolt, turn up

the variac supplying ac power to the coil. What you will see the the copper tube begin to float up the bolt! Try pushing it down. Try cranking up the voltage on the coil (take care not to exceed the rating of the coil!).

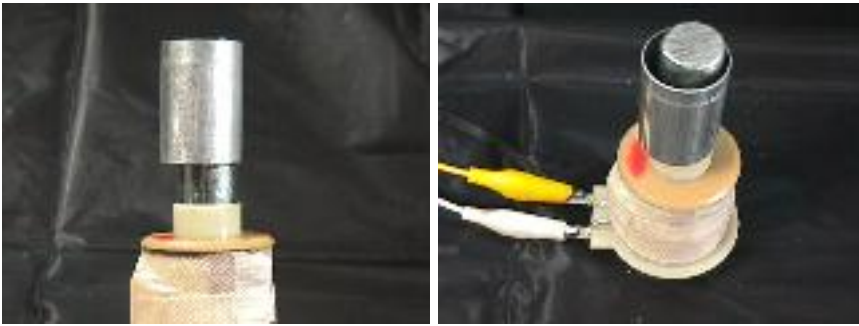

Next, try the same thing with a section of aluminum tubing. How does it behave? Does it float higher with the same voltage on the coil?

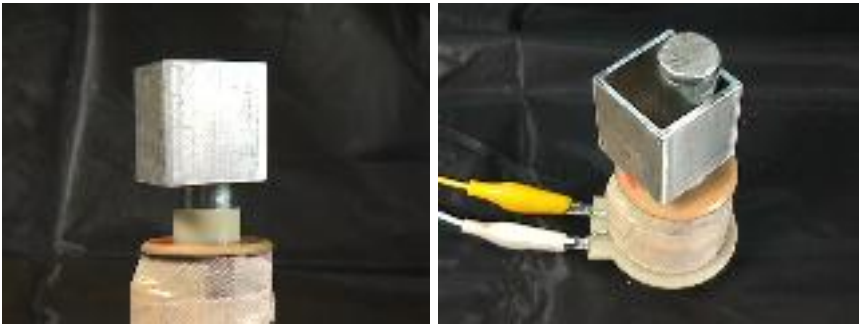

For some more fun, try the same thing again with a section of square aluminum tubing. It's amazing how electrons can zip around corners just about as easily as it can go in circles!

Three more experiments.

- Instead of bringing the voltage of the variac up gradually, set it at the max voltage the coil can take, and quickly switch the voltage to the variac on and off to see what happens!
- Cut a slit lengthwise through one of the sections of tubing. How does it behave?
- Connect DC to the coil and see if you can make the tube float.

Conclusions:

The tube will float because of eddy currents created by the changing

magnetic field from the coil. The polarity of the eddy current fields will be the opposite polarity (creating a North pole at the bottom of the tube when there is a North pole at the top of the coil, and vice versa) as the polarity of the coil, causing a repulsion between the two.

The section of tubing with the slit will not float because there is an incomplete circuit for the eddy currents, so no induced magnetic field is created.

With DC on the coil, nothing will happen because the magnetic field is not changing, so no eddy currents are induced in the section of tubing.





Experiments with electromagnets

Jumping Ring EXPT

This is a great demonstrator of [Lenz's Law](#), and an extension of the [Floating Tube](#) experiment. All that is needed is to slide the AC electromagnet coil over an 8" long bolt, place an aluminum or copper tube over the bolt, and energize the electromagnet for a short time, like a only second! The tube will shoot off the end of the bolt and go sailing through the air. To give it a greater distance, cool the tube in some liquid nitrogen to get it really cold (and make its resistance much lower) then place it onto the bolt and give the coil a short pulse of current. The distance the tube will travel could be twice as long.

You may find something like this in a science museum (such as the Franklin Museum in Philadelphia, or the Discovery Place in Milwaukee). You push a button on an electromagnet and an aluminum ring is propelled over an arch to another electromagnet. Press a button on the other electromagnet, and the ring is shot back to you. Great fun!

To make one that can shoot a ring several feet into the air, a larger AC electromagnet is wound onto a long laminated core which is much longer than the core is. When energized, an aluminum ring resting on top of the coil will shoot off into the air.

Details are given in:

Propulsion without Wheels

E. R. Laithwaite

Hart Publishing Company

New York, NY 1968

(see pages 130-131)





Experiments with magnetic levitation

Floating Ball EXPT

There are actually two experiments which involve an aluminum ball or hollow sphere which floats in the air. These demonstrations do require some skill in assembly and winding coils.

The first is where a hollow aluminum sphere is able to float above a single phase coil. Eddy currents are the means by which the magnetic field within the ball will repel the magnetic field produced by the coil. Details are given in:

Propulsion without Wheels

E. R. Laithwaite

Hart Publishing Company

New York, NY 1968

see pages 180-186

The second is where a hollow aluminum sphere floats between two helical coils. This is called the Kerst-Murray Levitator. More information is given at:

[Physics Demonstrations, A Sourcebook for Teacher of Physics](#)

Julien C. Sprott

1996

see chapter 5 at <http://sprott.physics.wisc.edu/demobook/chapter5.htm>





Experiments with magnets interacting with other magnets

Levitating Train

Description:



This is a great demonstration of like poles repelling each other. We have a platform which floats above a pair of magnetic tracks, and can be gently pushed to one end or the other. This is similar in concept to the MAGLEV trains which are being worked on in Germany, Japan and France.

Construction: EXPT



The tracks are simply two magnet strips, each measuring about 24" long, 1/2" wide, 1/8" thick, with their North side facing up. They are placed about 1/8" in from the edges of a piece of 3/4" thick wood shelving (with a white melamine surface) base, 24" long and 4" wide. Ends and a back wall are attached to the base, about 3" tall. The front of the base has a Plexiglas wall attached to it, so that you can see the train platform float above the tracks.

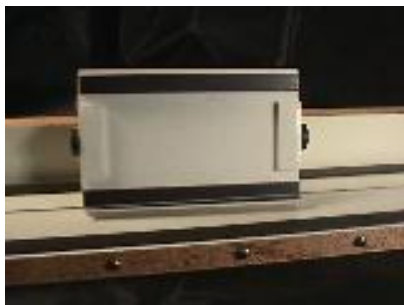

The train platform is made of foam-core board, 3 and 7/8" wide by 6" long and 1/4" thick. On the bottom is a pair of magnet strips, about 6" long, 1/2" wide, 1/4" thick, with their North side facing down. They are placed about 1/8" in from the side edges.



Attached to the ends of the base and to the ends of the train platform are smaller disk ceramic magnets, placed so that the North ends face each other so that they act as springs when the train reaches the end of the track. An extra strip of foam-core board was added to the top and bottom to provide a larger area to attach the end magnets.

Along the side edges of the platform was placed a strip of Teflon tape. This provided a very smooth, slippery surface for the train to rub against as it travels down the track. The back wall and the Plexiglas front wall are needed to keep the platform centered above the tracks. What would happen if they weren't there?

The [LEGO](#) people were added as passengers for interest.

An excellent site for more in-depth information on MAGLEV trains:

www.calpoly.edu/~cm/studpage/clottich/fund.html

Demonstration:

Give the train platform a gentle push from one side to the other. You will see it float over the tracks. The magnets on the ends keep the platform from hitting the ends (don't smash it into the ends!).

Conclusions:

This is just a fun experiment which demonstrates the like poles repelling principle of magnetics. There are four pairs of poles repelling each other on this train.

This is a simplified diagram showing the areas of attraction and repulsion between the magnets for this experiment.

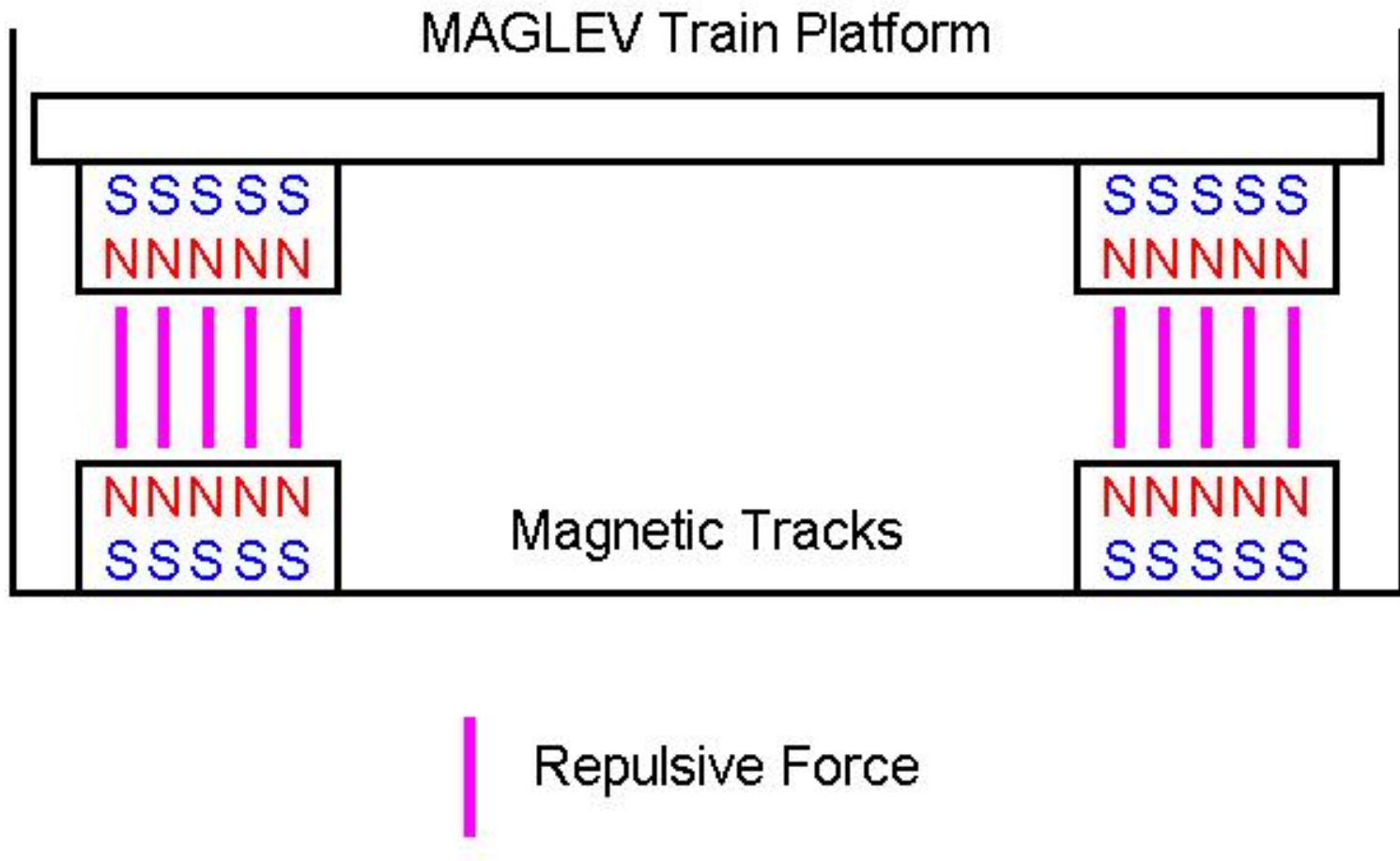

The magnets we used for our experiment were from a kit put together by Dowling Magnets (Sonoma, CA) called Magnetic Levitation Set - [SDK100](#).

[Dowling Magnets Catalog](http://www.jalts.com/nature/dowling) (<http://www.jalts.com/nature/dowling>).

Just A Lil' Toy Store
Char Herron
17031 Cedar Ave
Sonoma CA 95476
707 935 6514

They provided the two long magnet strips for the "tracks" as well as the two

shorter pieces for the bottom of the platform. We mounted the tracks onto a piece of shelving, and used a piece of foam core board for the platform. This worked out better than the wooden pieces which came with the kit. Don't forget the sides to keep the platform centered above the tracks! This kit costs about \$23, but it's possible to purchase only some of the strip magnets for a lot less from Dowling Magnets.

Since the foam core platform we used was so light, the magnets do not have to be real strong. With the ones that came in the kit, the bottom of the platform magnets float about 1/4" above the tracks.

Also available from Edmund 81-462, AS&S 89714





Experiments with magnets and conductors

Types of conductors and their properties

Many types of materials can conduct electricity.

Take these materials listed here and put them in order from lightest to heaviest with respect to their densities, that is, weight per unit volume:

aluminum, copper, gold, iron, lead, mercury, silver, water, zinc

[Ready to check your answer?](#)

If you were to put the metals in order from best to worst in terms of their electrical conductivity property, how would the list go? Remember, the lower the resistivity, the higher the conductivity.

[Ready to check your answer?](#)

Now, how does the product of (density * resistivity) compare? This is a way to determine the ratio of the best conductor with the lowest weight. The lower the density, the lighter it is; and the lower the resistivity, the better conductor it is.

[Ready to check your answer?](#)

This information is useful to figure out how the next experiment works:
[Pendulum.](#)





Densities of materials

metal	g/cm ³	lb/in ³	lb/ft ³	lb/gal
water	1.00	0.036	62	8.35
aluminum	2.70	0.098	169	22.53
zinc	7.13	0.258	445	59.50
iron	7.87	0.284	491	65.68
copper	8.96	0.324	559	74.78
silver	10.49	0.379	655	87.54
lead	11.36	0.410	709	94.80
mercury	13.55	0.490	846	113.08
gold	19.32	0.698	1206	161.23

The lb/gal column is used for comparison to a gallon of milk, which weights about 8.4 lb (it's mostly water). If that milk were changed to aluminum, it would weigh about 22.5 lb. If it were changed to gold, it would weigh about 161 lb (19 gallons of water)! Did you notice that copper is heavier than iron? A cubic foot of iron is 491 lb. A cubic foot of copper is 559 lb. Silver is even heavier than copper, at 655 lb for a cubic foot. Gold is really heavy at 1206 lb for a cubic foot. When you see a movie of thieves carrying bars of gold, you know they are faking it!





Resistivity of materials

metal	resistivity, nano-ohm-meter
silver	14.71
copper	15.80
gold	20.11
aluminum	25.00
zinc	54.55
iron	87.10
lead	193.00
mercury	983.96

So, silver is the best conductor, at least at room temperature. (At very low temperatures, lead becomes a superconductor where its resistivity becomes 0.00!) Copper is close to silver, and is much less expensive. Aluminum is not far behind, and is less expensive than copper.





*Density*resistivity of materials*

metal	density * resistivity
aluminum	67.50
copper	141.57
silver	154.31
gold	388.53
zinc	388.94
iron	685.48
lead	2192.48
mercury	13332.68

Aluminum is by far the best, that's why it is used by the power companies for the high voltage power cables strung from tower to tower. It is very light and a very good conductor, and inexpensive, too! A great combination. Copper comes next, amazing since it is heavier than iron.

The units here are $\text{g/cm}^3 * \text{nano-ohm-meters}$.





Experiments with magnetic levitation

Floating Pie Pan EXPT

This exhibit is presently under construction. When I have something to show, I'll add it here.

This is something I first found out about from the original [Mr. Magnet](#). He also has a [slide show](#) of his demonstrations at a local school.

Plans for this can be found in the following reference:

Physics Demonstration Experiments Vol 2 (Heat, E&M, Optics, Atomic and Nuclear Physics)

Harry F. Meiners

The Ronald Press Company, NY

1970

It can be found under the Magnetism section 31-2.22, page 945.

This requires a fair amount of work to build. Steel laminations need to be procured, cut, mounted, oil filled caps are needed, and two large center-tapped windings of about 1000' each need to be wound and varnished. Cost will be about \$500 plus labor.

I may start with a different kind of levitator.





Experiments with magnetic levitation

Floating Paper Clips EXPT



Tying a paper clip to a thread and holding it away from a magnet, as shown in the photo, is a way to use magnetism to levitate an object. Of course, the object needs to be held back. Try "twanging" the thread to see how much force the magnet is pulling the clip with. Does this vary as you allow the clip to get closer to the magnet?

This is a way to compare the strengths of magnets you may have around the house:

- First, find either the North or South pole of the magnet and attach it to a metal bracket.
- Next, hold a paper clip, tied to a thread, near the magnet so that the magnet will suspend the clip.
- See how far away from the magnet you can pull the paper clip until it falls away from the magnet. Use a plastic ruler as a way to measure the distance.

Another experiment would be to see how many paper clips can be hung end-to-end from the magnet.

Does it make a difference if there were a ball bearing on the bottom of the magnet and you hung the paperclips to the ball bearing?





Experiments with magnets and conductors

Spinning Copper Plate

Description:



This is an example of Lenz's law and Eddy currents. It is similar to the experiments described under the heading of "Experiments with magnets and conductors", but this has a definite property of levitation to it. As a copper disk spins slowly beneath a magnet, the magnet floats in the air.

Construction: EXPT



This is basically a 1/4" thick, 12" diameter copper plate mounted to a motor, with a way to hold a magnet on a string. The motor is a DC motor mounted to a box built with 3/4" particle board shelving, with a white melamine finish.



The motor is pictured here with the box tipped onto its side. Mounted to the end of the motor shaft is a hub to which the plate is secured.

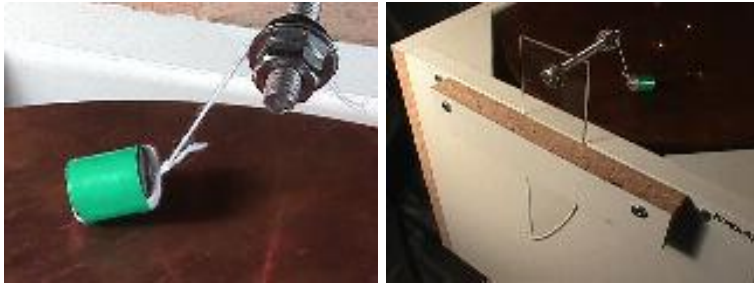

The magnet is wrapped with about eight turns of kite string, and taped. The magnet is actually made up of three NIB magnets, each 1/2" diameter and 1/8" thick. They are then tied to a string which is fastened to a Stainless Steel bolt, two nuts and two washers. The bolt is fastened to a Plexiglas piece clamped to the back of the box as shown. This allows the height and depth of the position of the magnet to be changed. When the plate spins, the magnet floats about 3/8" above the plate.



The motor is controlled from a very simple drive made up of a variac and two diode bridges. The schematic is shown below. This is a very quiet unit. I had tried an SCR drive, but it was noisy and provided too much torque. This variac drive was nice since it had little torque so in case someone's finger became caught or pinched, the motor would stop. We experimented with different speeds of the motor, and found that a speed of about 60rpm worked very well. For the display, we removed the knob from the variac so others would not be able to change the speed of the motor. All an observer could do is turn the switch on and off. This is a heavy unit, weighing about 50lbs!

Demonstration:

Turn the switch on. As the motor speeds up to about 60rpm (1 revolution every second) you will notice that the magnet will begin to float above the copper plate, where before it was resting on the plate. As the plate continues to spin, the magnet will continue to float. Turn the switch off. As the plate slows down, the magnet begins to float closer and closer to the plate's surface, until it finally rests on the surface of the copper plate when the plate has stopped spinning.

This is a great demonstration of [Lenz's law](#), and one which is seldom observed. A

variation would be to place a small wooden car onto the plate, with a NIB magnet under its front and back, and attach it to the post. This would simulate how a levitating train basically behaves.

This is a simple diagram showing the attraction and repulsion areas in this experiment.

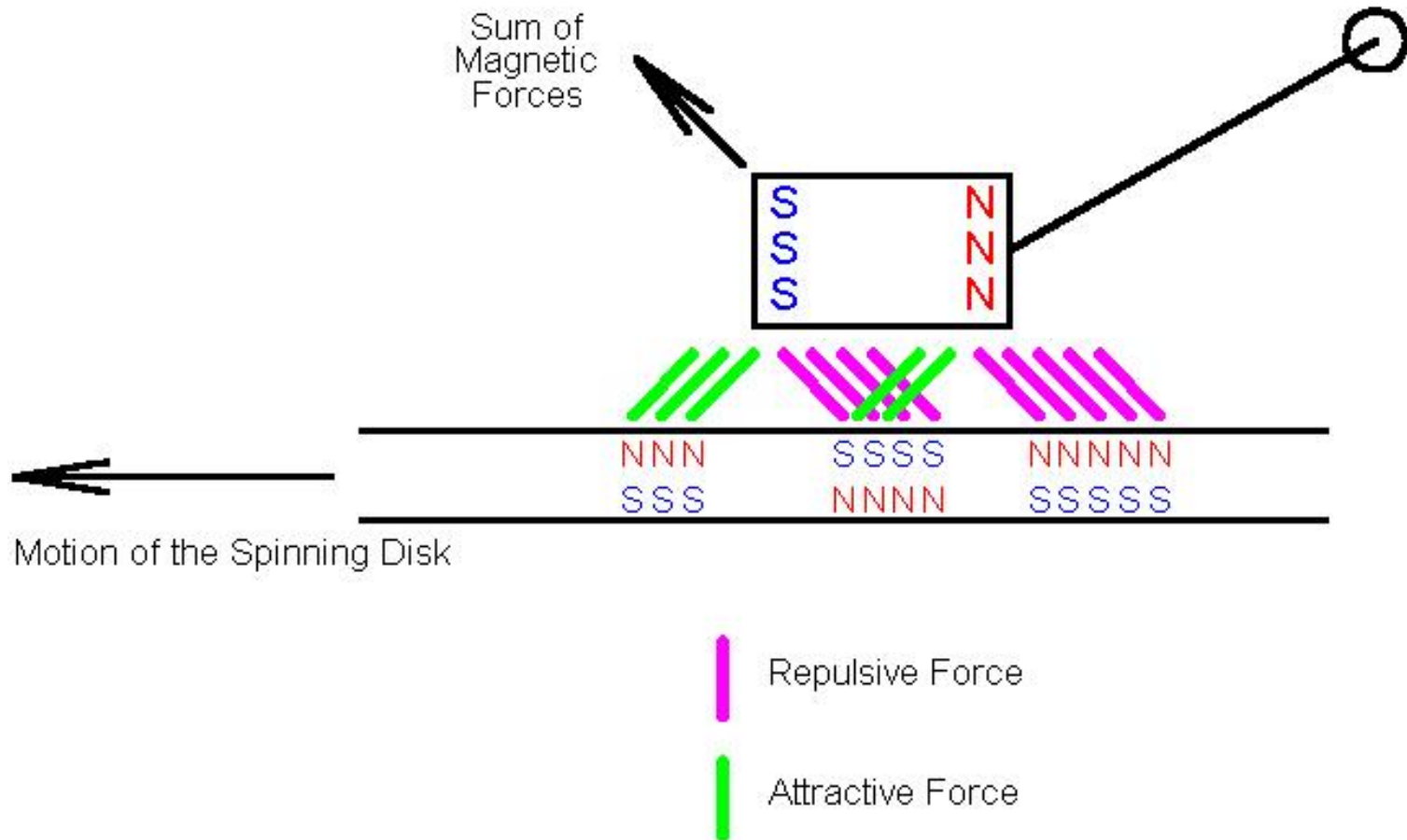

Similar to the pipes experiment, I am not 100% certain of the fields created when there is relative motion between the magnet and the moving copper plate.

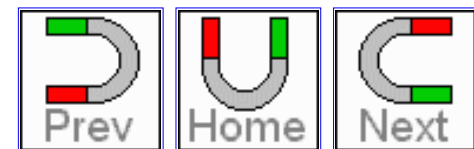



Experiments with magnets and conductors

Aluminum Disk (an Eddy Current Brake)

Description:

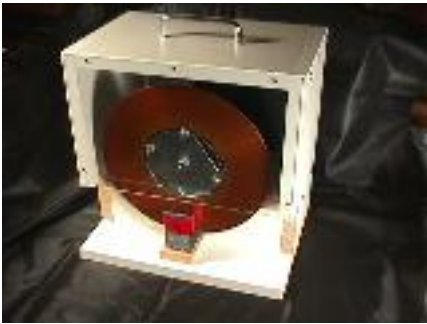

This is another example of [Lenz's Law](#) and Eddy currents, just like the [Pendulum](#) experiment. This time, instead of having the aluminum pendulum swing back and forth through the magnetic field set up between the two magnets, an aluminum disk is spun by a motor, and the magnets are moved into position. When this is done, the disk and motor are caused to slow down, like putting on a brake, but without touching the disk. Since this uses Eddy currents, it's called an Eddy Current Brake.

Construction: EXPT

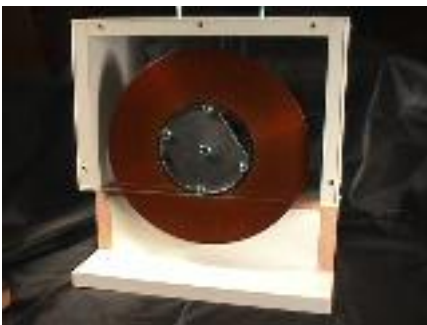

This experiment is made by mounting an aluminum disk to the shaft of an electric motor. The disk was purchased at a surplus store, and was the hard

disk from an old computer drive. It measures 9" in diameter with a 4" hole in the middle and is about 0.090" thick. The brown coloring on the disk was, of course, the area where the disk had its tracks and sectors and stored the bits of information. It was mounted to an aluminum plate with four screws, and the plate was mounted to the shaft of the motor.



The motor is a universal motor, and operates at about 3600 rpm with 15Vac applied to it. The supply is a plug-in supply which is rated at 25W with 120Vac in. Its output rating is 19Vac at 0.84A. I measured about 21.9Vac at no load. With the motor spinning, it would measure 14.9Vac at 2.36A. When the magnets were present braking the motor, it would supply 15.3Vac at 2.60A. Since it wouldn't run for more than 3 to 4 minutes for the demonstration, the plug-in supply never gets hot. The motor is mounted to the inside shelf with two "L" brackets.

The box is made of pressboard shelving with a white melamine finish. This works real well and gives the unit a nice, clean look to it. A handle was added to the top of the box to make it easy to carry around.

Demonstration:



Begin by plugging in the power supply to start the motor spinning. After a few seconds, it will be up to speed. Then, slowly slide the pair of magnets into position so that the aluminum disk is in the gap between the North and

South poles. Hang onto the magnets so they aren't pushed away! The disk will slow down to a crawl, and continue spinning, until you remove the magnets.

Conclusion:

As the aluminum disk spins through the magnetic field, eddy currents are induced within the disk, creating magnetic fields which oppose the relative motion of the disk to the magnets you are holding in position. This creates a braking force, slowing down the disk.

This principle is often used in industry to brake or stop a spinning motor, without requiring brake pads like on a car. Instead of a permanent magnet, though, an electromagnet is often used. With that, you can control the braking torque from zero to full with a simple control or dial.

